

Technische Daten: Art.-Nr.: 870200

Wandaußenmaß: 400 x 500 cm

Bohlenstärke: 70 mm



Kontrolliert durch:

Achtung: Alle angegebenen Maße sind ca.-Maße!

3D-Darstellung und Grundriss 870200

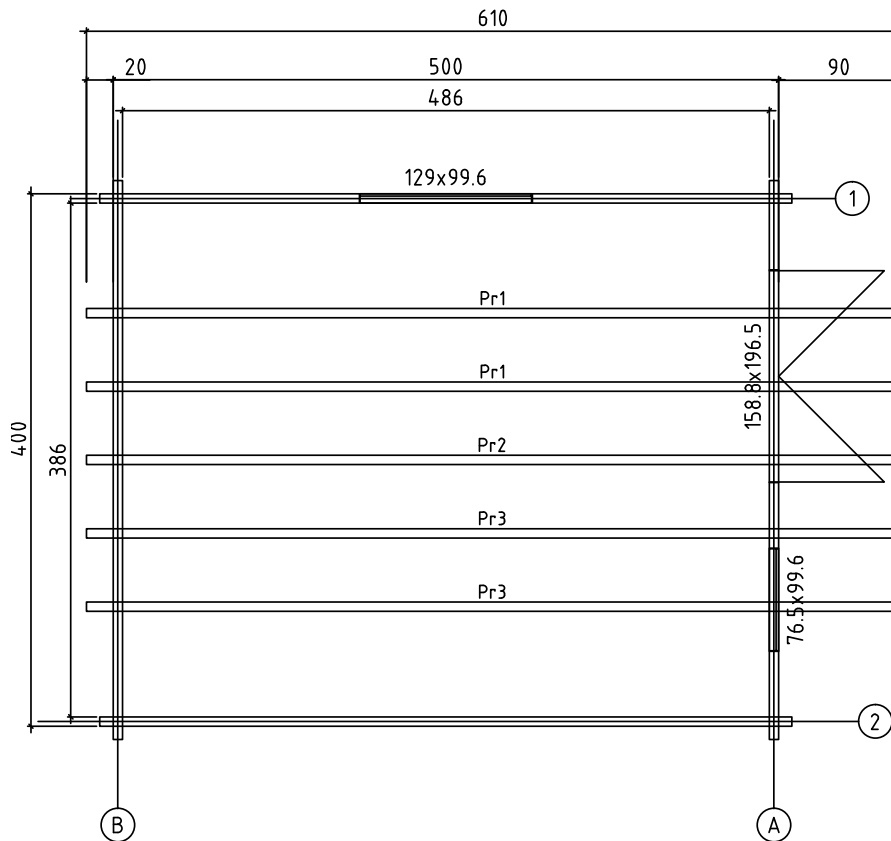
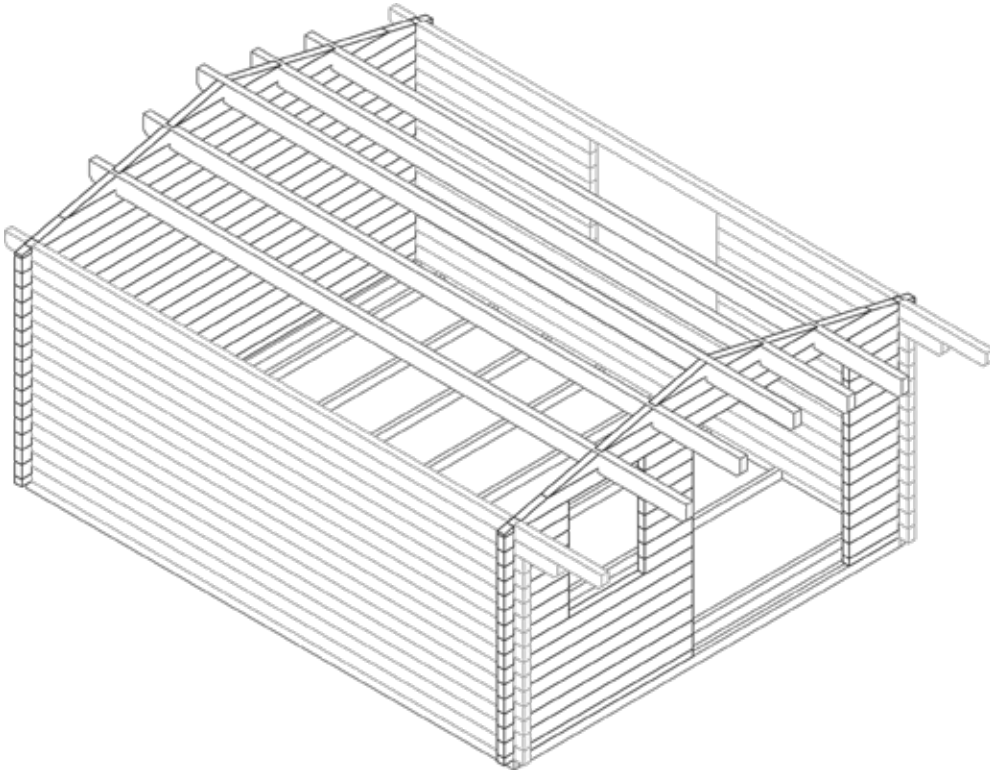

Lagerholzplan und Fundamentplan 870200

Wir empfehlen als Fundament für Ihr Gartenhaus eine vollflächig,
festgegründete gepflasterte oder betonierte Fläche.





Wahlweise ist auch ein Punkt- oder Streifenfundament möglich.

Frei wählbare Abstände aller innenliegender Fundamenthölzer.
Maximaler Abstand jedoch 65 cm.



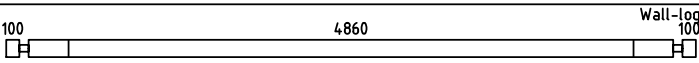
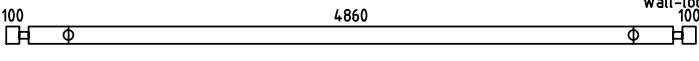
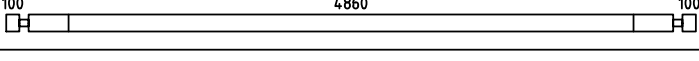
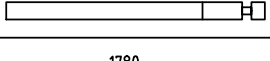
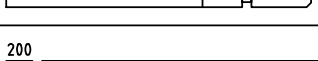
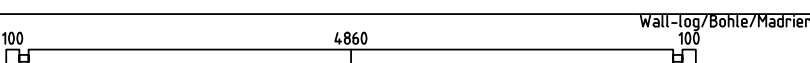
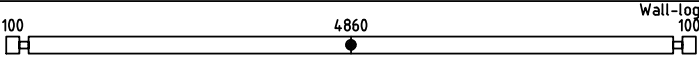
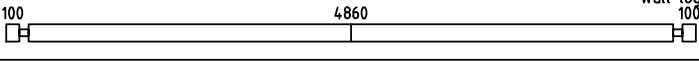
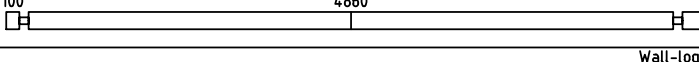
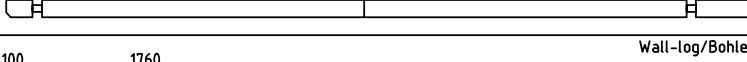
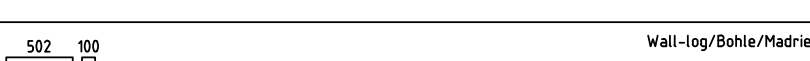
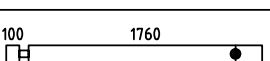
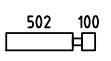
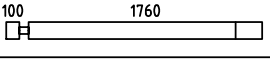
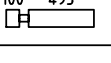
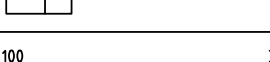

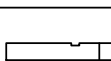

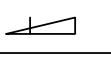
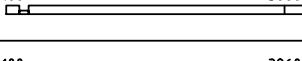
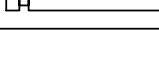
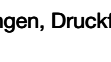
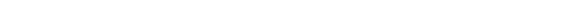



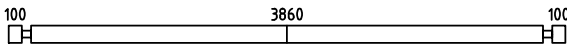
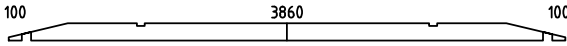
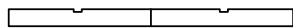

Teileliste 1

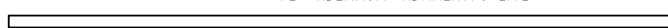
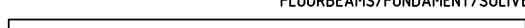
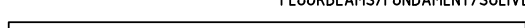
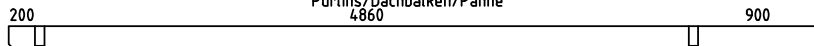
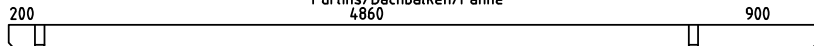
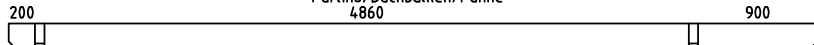
870200

Pos		Arv	Profil (mm)	LENGTH (mm)
001		1	70x130	5200
002		1	70x130	5200
003		5	70x130	5200
004		15	70x130	1950
005		1	70x130	2300
006		1	70x130	6100
007		1	70x130	5200
008		1	70x130	5200
009		12	70x130	5200
010		1	70x130	5550
011		1	70x130	6100
012		1	70x65	1930
013		1	70x65	672
014		1	70x130	1930
015		15	70x130	672
016		6	70x130	1930
017		8	70x130	663
018		8	70x130	493
019		1	70x130	4200
020		11	70x123	521
021		1	70x130	2146
022		1	70x130	1043
023		1	70x123	521
024		1	70x65	4200
025		1	70x130	4200

Teileliste 2

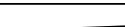
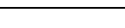
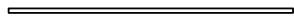
870200

Pos		Arv	Profiil (mm)	LENGHT (mm)	
026		Wall-log/Bohle/Madrier	14	70x130	4200
027		Wall-log/Bohle/Madrier	1	70x130	4200
028		Wall-log/Bohle/Madrier	1	70x130	2146
029		Wall-log/Bohle/Madrier	1	70x130	1043
GR2	FLOORBEAMS/FUNDAMENT/SOLIVE 		2	45x90	4990
GR1	FLOORBEAMS/FUNDAMENT/SOLIVE 		2	45x90	3900
FB1	FLOORBEAMS/FUNDAMENT/SOLIVE 		10	45x90	3900
Pr1	Purlins/Dachbalken/Panne 4860 		2	70x170	6100
Pr2	Purlins/Dachbalken/Panne 4860 		1	70x170	6100
Pr3	Purlins/Dachbalken/Panne 4860 		2	70x170	6100
	WINDOW/FENSTER 1290x996		1		
	WINDOW/FENSTER 765x996		1		
	DOOR/TÜR 1588x1965		1		
1	Screws/Schrauben/Vis 5x100 mm- For fixing first row of wall logs /Fixierung des ersten Bohlenkranzes/Pour fixer les lames de plancher		6		
2	Nails/Nägels/Clous 2.5x50 - For fixing floorboards/ Befestigung Fussbodenbretter/Pour fixer les lames de plancher		360		
3	Nails/Nägels/Clous 2.5x50 - For fixing roofboards/ Befestigung Dachbretter/Pour fixer les voliges		500		
4	Nails/Nägels/Clous 2.5x50 - For fixing floor edge trims/ Befestigung Fussleisten/Pour fixer les plinthes du plancher		30		
5	Nails/Nägels/Clous 2.5x50 - For fixing roofing felt fillet/ Befestigung giebelabschlussbrett/Pour fixer la latte de finition de la couverture		20		
6	Screws/Schrauben/Vis 2,5x50 mm- For fixing roof side boards and roof edge reinforcement Befestigung Traufenbretter und Traufenleisten Pour fixer les planches de rive et le tasseau de refrent		44		
7	Screws/Schrauben/Vis 2,5x50 mm- For fixing fascia boards and diamonds/ Befestigung Giebelblende und Raute Pour fixer les planches de rive et le diamant		28		
8	Screws/Schrauben/Vis 2,5x50 mm- For fixing fwindow and door trims/ Befestigung Fenster und türen/ Pour fixer les croisillons des fenetres et des portes		44		
9	Metal storm Brace/Gewindestange/Tige filetee 10 mm 		5		
10	Shim/Nuts/Mutter ,U-Scheibe/Ecrou,Rondelle 10 mm For fixing storm braces/ Pour fixer les anti tempete/ Für Sturmleisten Pour fixer les croisillons des fenetres et des portes		5		
	Metal storm Brace/Gewindestange/Tige filetee 10 mm				
	KL1 M10 2,51 1 Plastic caps 5 pcs. KL2 M10 2,63 1 Screws 180 10 pcs. KL3 M10 2,18 3				

Teileliste 3

870200

POS	ST.	B	H	L	ERKLÄRUNG
FB1	Vt. spetsi				Fundamentholzer
F2	18,75 m	220		4855	Fussbodenbretter 45/34/28
R1	5	70	170	6100	Dachbalken
R2	28,24 m ²	20		2315	Dachbretter 125/95/73
R3	4	20	120	3050	Traufenbrett
R4	4	45	65	3050	Traufenbretter
R5	4	20	120	2500	Dachpappenfixierung
R6	4	20	90	2500	Giebelblende
WN07 WN13	1 1	765 1290	996 996		
DR16	1	1588	1965		
P1	20 m	20	40		Fussbodenleiste
P2	4	20	90	1945	Türleiste DR 16
P3	10	20	90	1100	Türleiste und Fensterleiste DR 16; WN 07
P4	2	20	90	1890	Türleiste DR 16
P6	2	20	90	725	Fensterleiste WN07
P7	2	20	90	1150	Fensterleiste WN013
P8	2	20	90	1590	Fensterleiste WN13

Wandpläne 1 und 2 870200

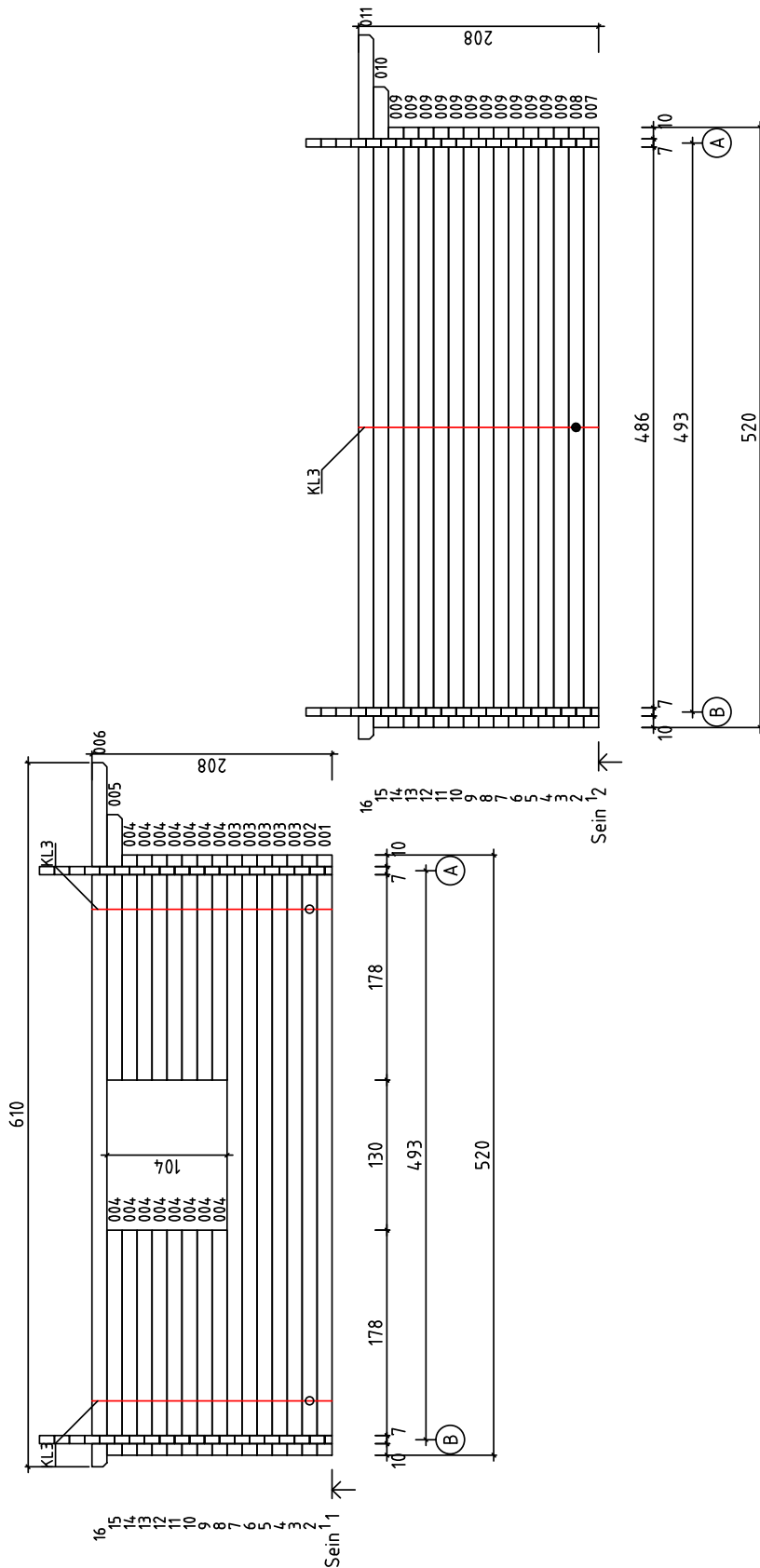

Wandpläne A und B 870200

