

material number: 2003831
 local article number: 133501

 ACO Ahlmann SE & Co. KG Am Ahlmannkai 24782 Büdelsdorf www.aco.com	drawing-no.: 1032367-M	index: 004	documenttype: marketing drw.
	created by: rkumar	reviewed by: smeier	projection: ISO-E 

title:
Multiline Seal in
Slope Channel V200S 1m 1 with galv. steel rail
Gefällerinne V200S 1m 1 mit verzinkter Stahlzarge

serial-released

The reproduction, distribution and utilization of this document as well as the communication of its contents to others without express authorization is prohibited. Offenders will be held liable for the payment of damages. All rights reserved in the event of the grant of a patent, utility model or design. Observe copyright by ISO 16016	release date: 07.02.2023	sheet: 1/1
--	------------------------------------	----------------------

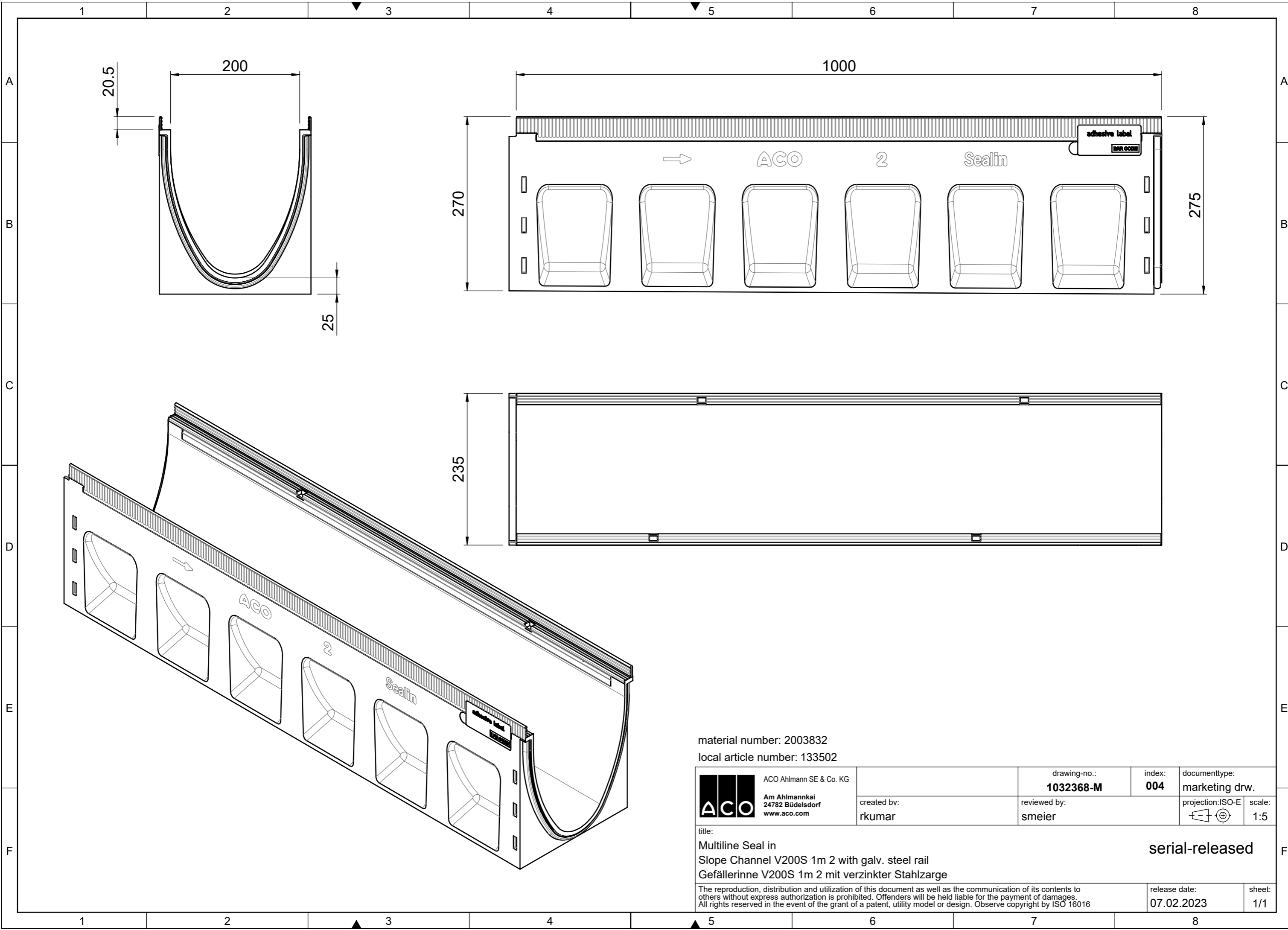

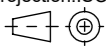

material number: 2003832
 local article number: 133502

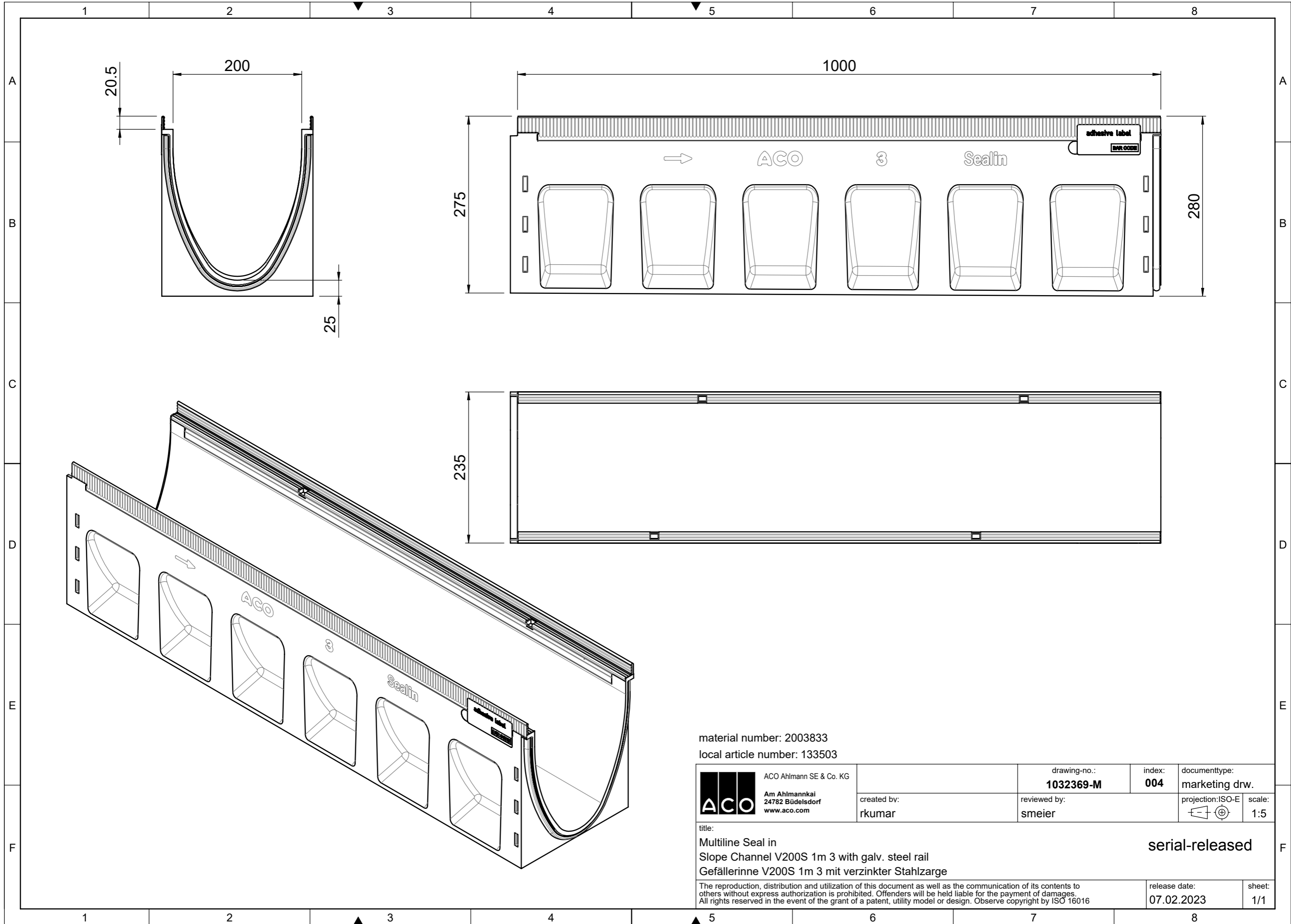
 ACO Ahlmann SE & Co. KG Am Ahlmannkai 24782 Büdelsdorf www.aco.com	drawing-no.: 1032368-M	index: 004	documenttype: marketing drw.
	created by: rkumar	reviewed by: smeier	projection: ISO-E 
title: Multiline Seal in Slope Channel V200S 1m 2 with galv. steel rail Gefällerinne V200S 1m 2 mit verzinkter Stahlzarge			serial-released
<small>The reproduction, distribution and utilization of this document as well as the communication of its contents to others without express authorization is prohibited. Offenders will be held liable for the payment of damages. All rights reserved in the event of the grant of a patent, utility model or design. Observe copyright by ISO 16016</small>			release date: 07.02.2023
			sheet: 1/1



material number: 2003833
 local article number: 133503

 ACO Ahlmann SE & Co. KG Am Ahlmannkai 24782 Büdelsdorf www.aco.com	drawing-no.: 1032369-M	index: 004	documenttype: marketing drw.
	created by: rkumar	reviewed by: smeier	projection: ISO-E  scale: 1:5
title: Multiline Seal in Slope Channel V200S 1m 3 with galv. steel rail Gefällerinne V200S 1m 3 mit verzinkter Stahlzarge			serial-released



The reproduction, distribution and utilization of this document as well as the communication of its contents to others without express authorization is prohibited. Offenders will be held liable for the payment of damages. All rights reserved in the event of the grant of a patent, utility model or design. Observe copyright by ISO 16016

release date:
07.02.2023 sheet:
1/1

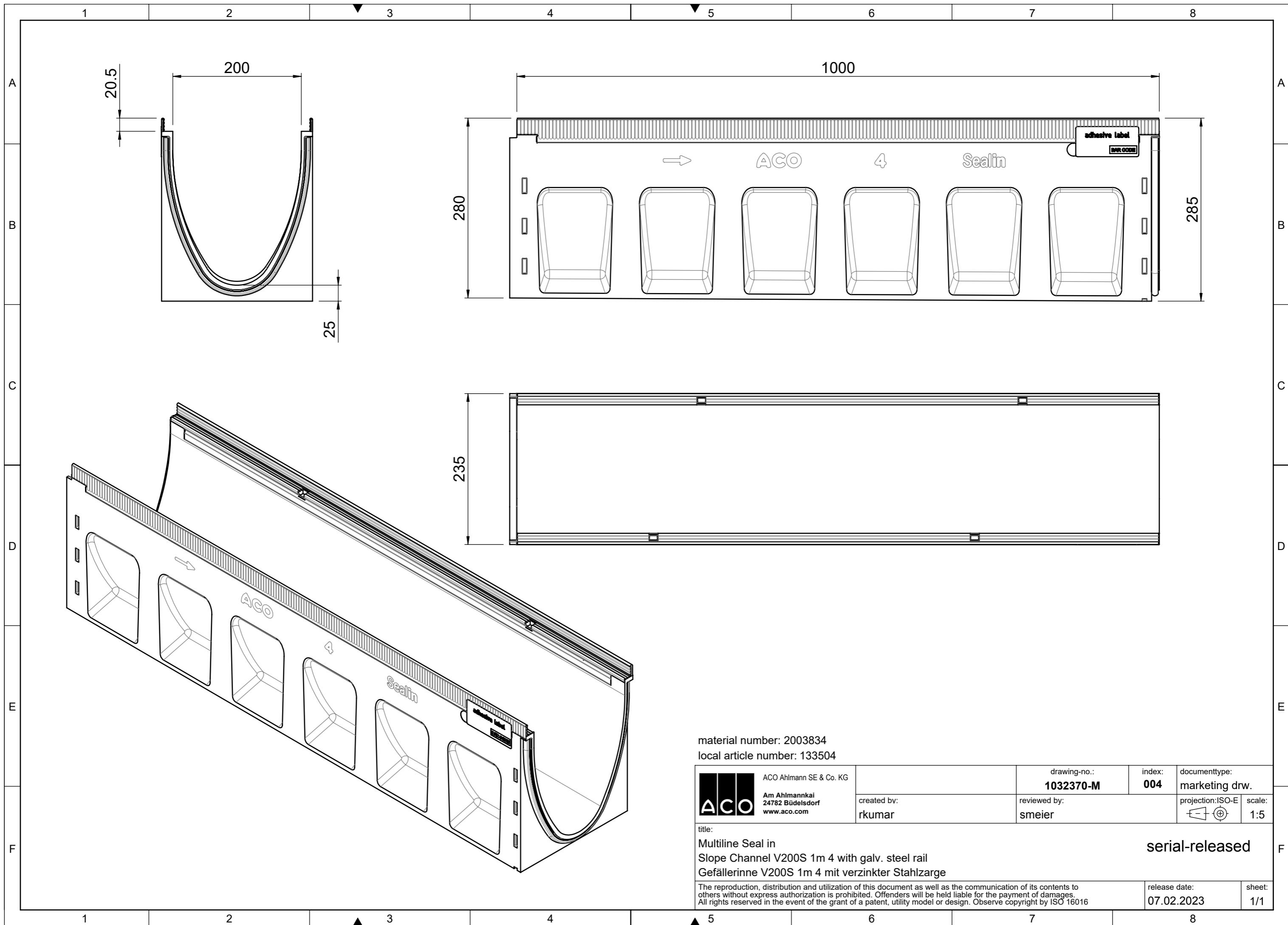
S:\Produktdaten\2023\1032369-M_133503_Versucht_1.6



material number: 2003834
 local article number: 133504

 ACO Ahlmann SE & Co. KG Am Ahlmannkai 24782 Büdelsdorf www.aco.com	drawing-no.: 1032370-M	index: 004	documenttype: marketing drw.
	created by: rkumar	reviewed by: smeier	projection:ISO-E 

title:
Multiline Seal in
Slope Channel V200S 1m 4 with galv. steel rail
Gefällerinne V200S 1m 4 mit verzinkter Stahlzarge

serial-released

The reproduction, distribution and utilization of this document as well as the communication of its contents to others without express authorization is prohibited. Offenders will be held liable for the payment of damages. All rights reserved in the event of the grant of a patent, utility model or design. Observe copyright by ISO 16016	release date: 07.02.2023	sheet: 1/1
--	------------------------------------	----------------------

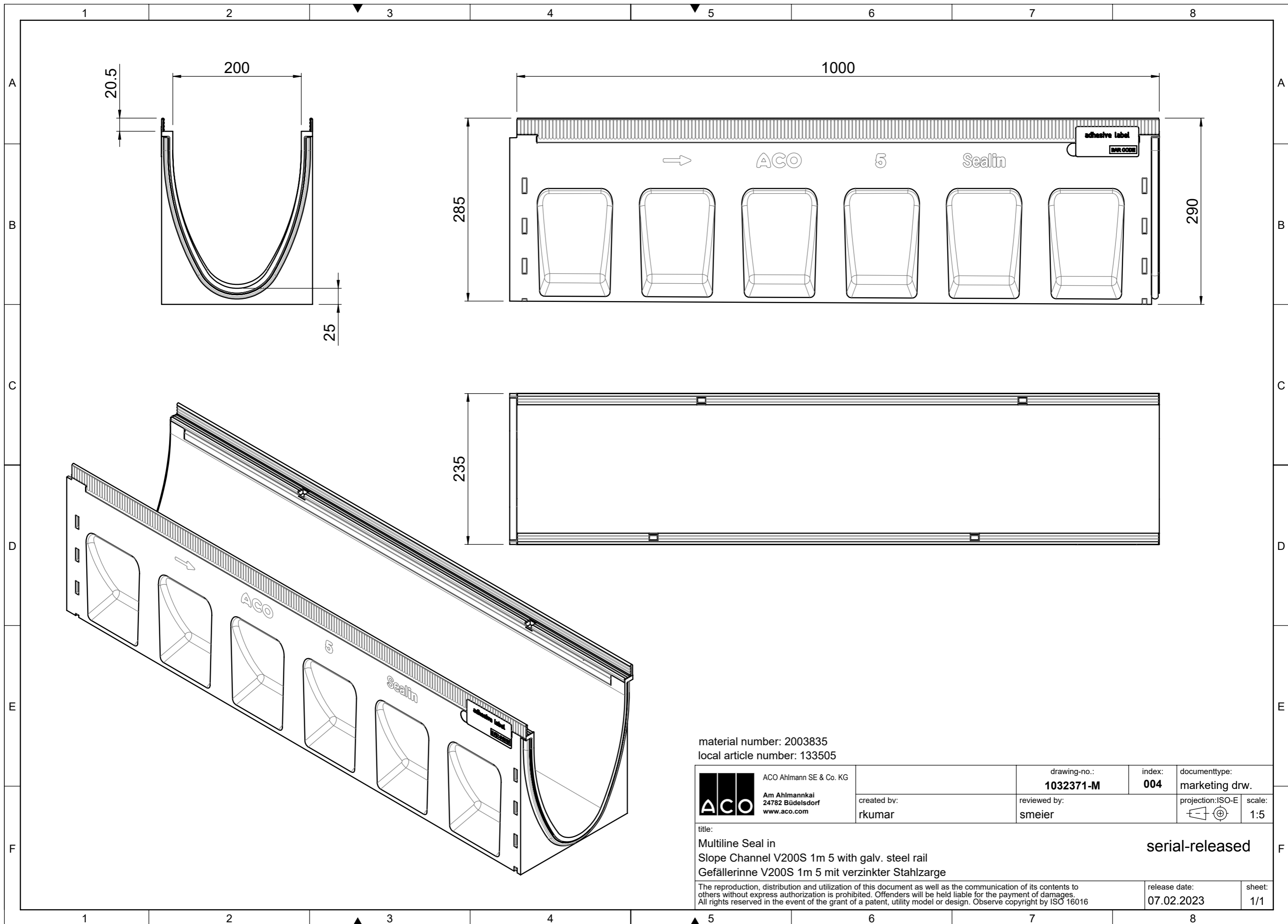

material number: 2003835
 local article number: 133505

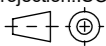
 ACO Ahlmann SE & Co. KG Am Ahlmannkai 24782 Büdelsdorf www.aco.com	drawing-no.: 1032371-M	index: 004	documenttype: marketing drw.
	created by: rkumar	reviewed by: smeier	projection: ISO-E 

title:
Multiline Seal in
Slope Channel V200S 1m 5 with galv. steel rail
Gefällerinne V200S 1m 5 mit verzinkter Stahlzarge

serial-released

The reproduction, distribution and utilization of this document as well as the communication of its contents to others without express authorization is prohibited. Offenders will be held liable for the payment of damages. All rights reserved in the event of the grant of a patent, utility model or design. Observe copyright by ISO 16016	release date: 07.02.2023	sheet: 1/1
--	------------------------------------	----------------------

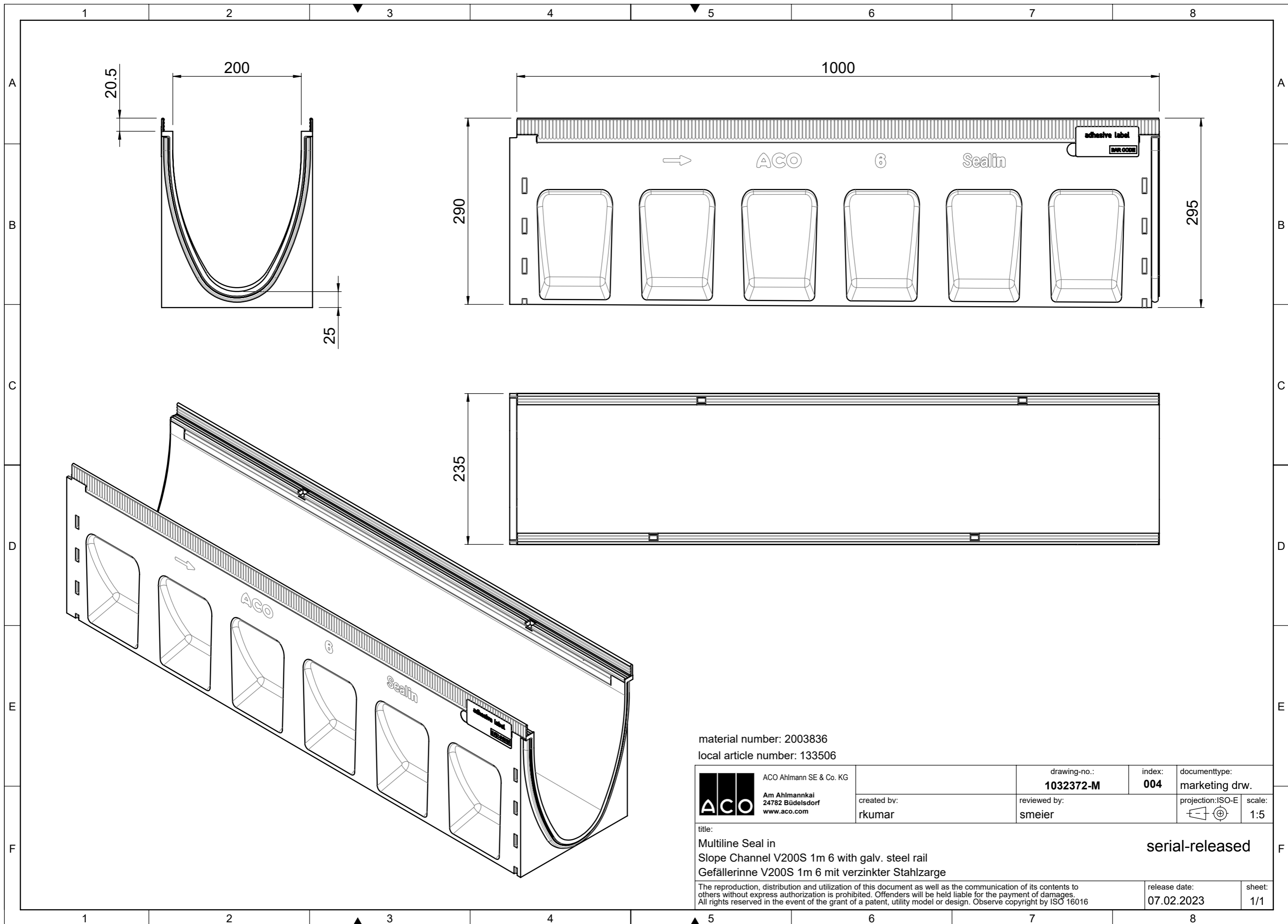

material number: 2003836
 local article number: 133506

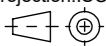
 ACO Ahlmann SE & Co. KG Am Ahlmannkai 24782 Büdelsdorf www.aco.com	drawing-no.: 1032372-M	index: 004	documenttype: marketing drw.
	created by: rkumar	reviewed by: smeier	projection: ISO-E 
title: Multiline Seal in Slope Channel V200S 1m 6 with galv. steel rail Gefällerinne V200S 1m 6 mit verzinkter Stahlzarge			serial-released
<small>The reproduction, distribution and utilization of this document as well as the communication of its contents to others without express authorization is prohibited. Offenders will be held liable for the payment of damages. All rights reserved in the event of the grant of a patent, utility model or design. Observe copyright by ISO 16016</small>			release date: 07.02.2023
			sheet: 1/1

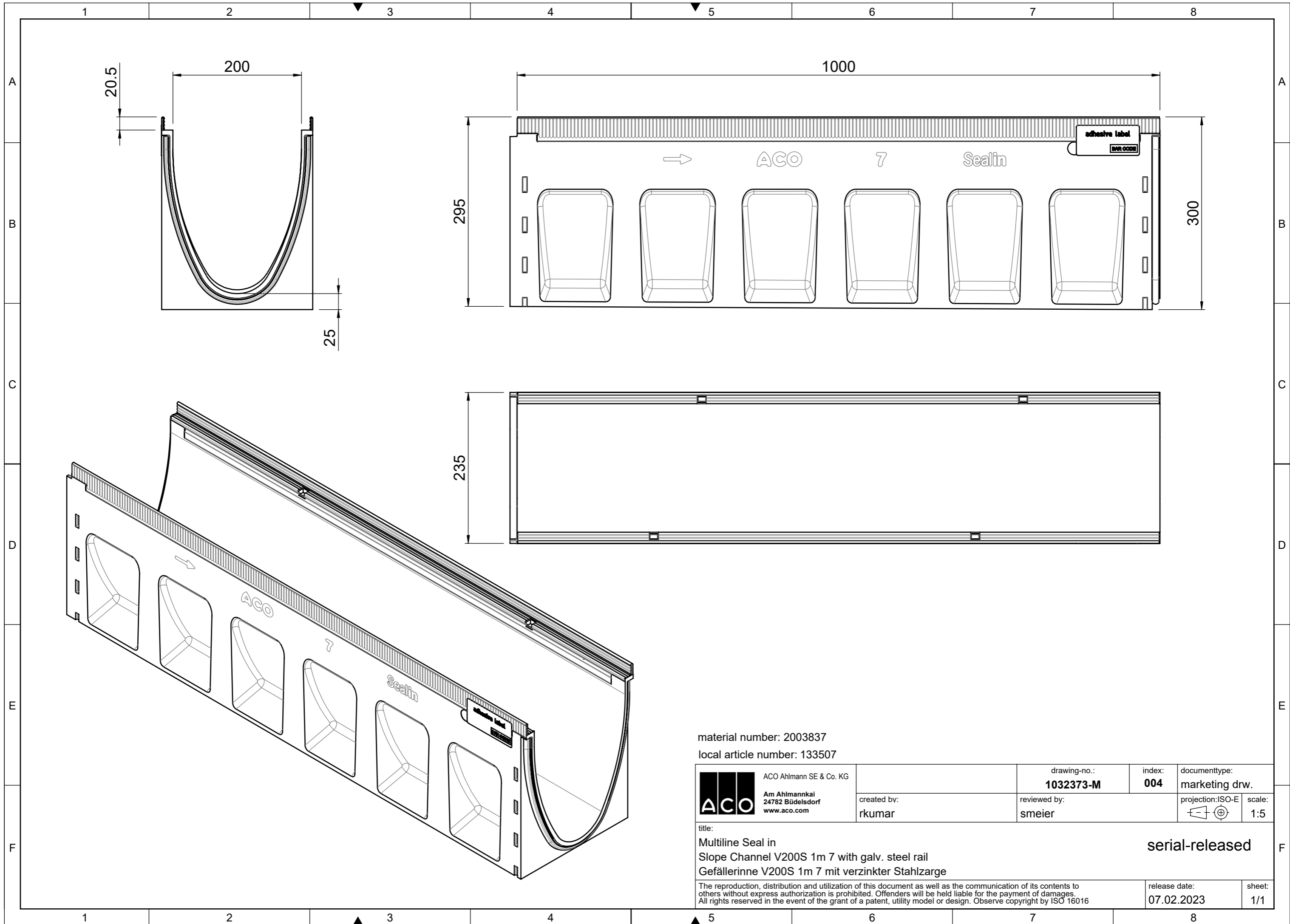

material number: 2003837
 local article number: 133507

 ACO Ahlmann SE & Co. KG Am Ahlmannkai 24782 Büdelsdorf www.aco.com	drawing-no.: 1032373-M	index: 004	documenttype: marketing drw.
	created by: rkumar	reviewed by: smeier	projection: ISO-E 

title:
Multiline Seal in
Slope Channel V200S 1m 7 with galv. steel rail
Gefällerinne V200S 1m 7 mit verzinkter Stahlzarge

serial-released

The reproduction, distribution and utilization of this document as well as the communication of its contents to others without express authorization is prohibited. Offenders will be held liable for the payment of damages. All rights reserved in the event of the grant of a patent, utility model or design. Observe copyright by ISO 16016	release date: 07.02.2023	sheet: 1/1
--	------------------------------------	----------------------

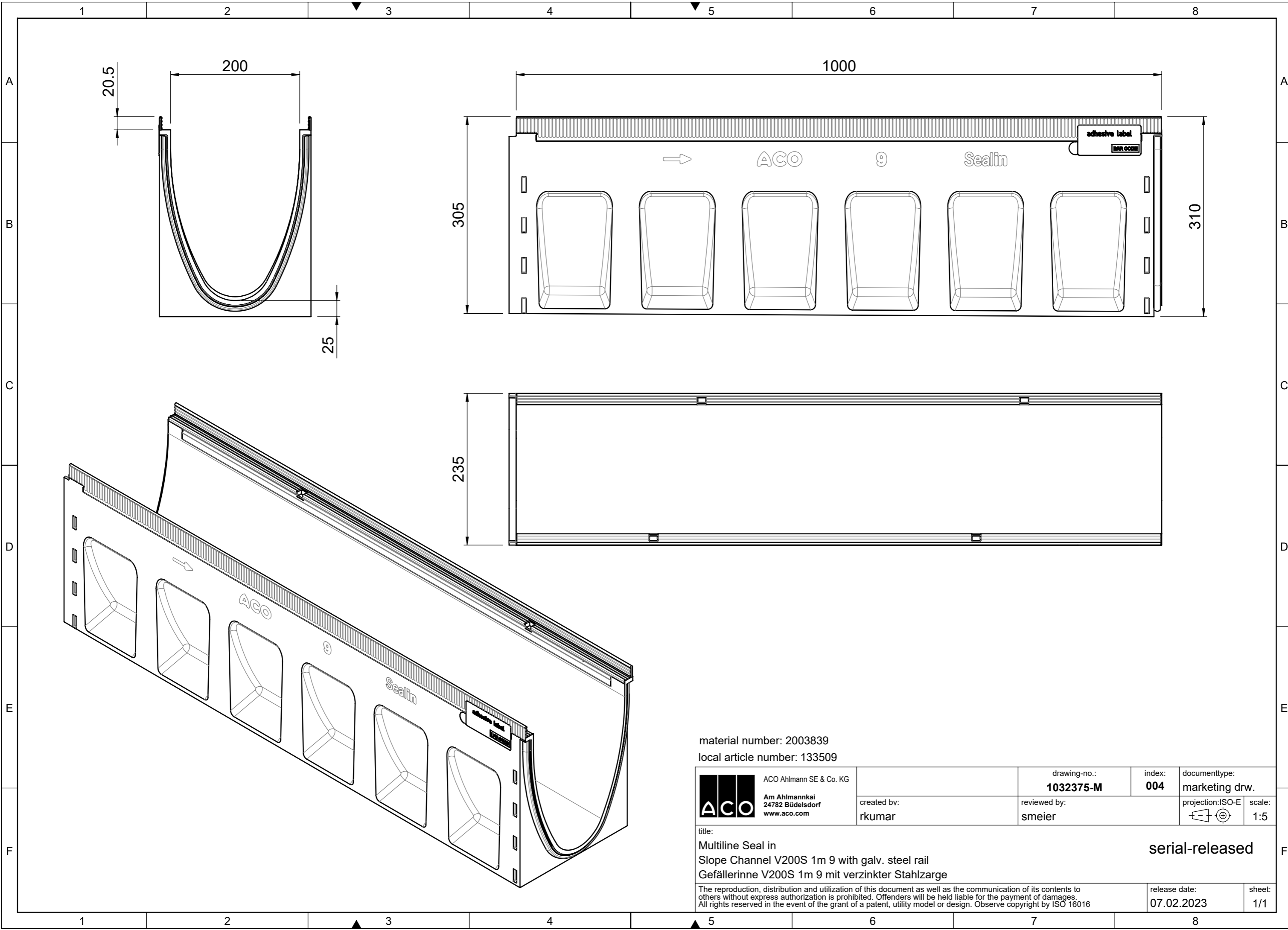

material number: 2003839
 local article number: 133509

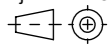
 ACO Ahlmann SE & Co. KG Am Ahlmannkai 24782 Büdelsdorf www.aco.com	drawing-no.: 1032375-M	index: 004	documenttype: marketing drw.
	created by: rkumar	reviewed by: smeier	projection: ISO-E 
title: Multiline Seal in Slope Channel V200S 1m 9 with galv. steel rail Gefällerinne V200S 1m 9 mit verzinkter Stahlzarge			serial-released
<small>The reproduction, distribution and utilization of this document as well as the communication of its contents to others without express authorization is prohibited. Offenders will be held liable for the payment of damages. All rights reserved in the event of the grant of a patent, utility model or design. Observe copyright by ISO 16016</small>			release date: 07.02.2023
			sheet: 1/1

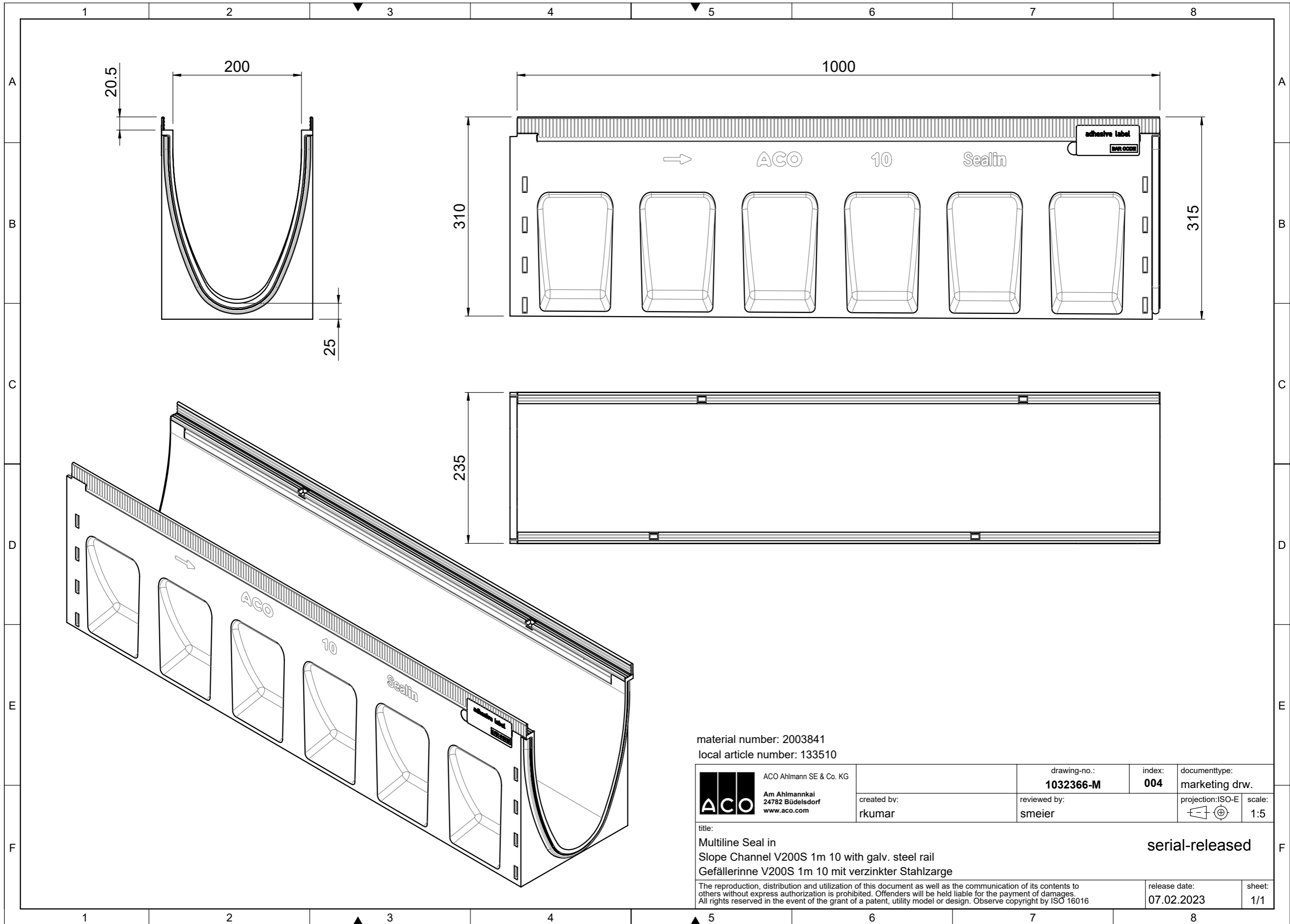

material number: 2003841
 local article number: 133510

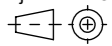
 ACO Ahlmann SE & Co. KG Am Ahlmannkai 24782 Büdelsdorf www.aco.com	drawing-no.: 1032366-M	index: 004	documenttype: marketing drw.
	created by: rkumar	reviewed by: smeier	projection: ISO-E 
title: Multiline Seal in Slope Channel V200S 1m 10 with galv. steel rail Gefällerinne V200S 1m 10 mit verzinkter Stahlzarge			serial-released

The reproduction, distribution and utilization of this document as well as the communication of its contents to others without express authorization is prohibited. Offenders will be held liable for the payment of damages. All rights reserved in the event of the grant of a patent, utility model or design. Observe copyright by ISO 16016

release date: 07.02.2023
 sheet: 1/1

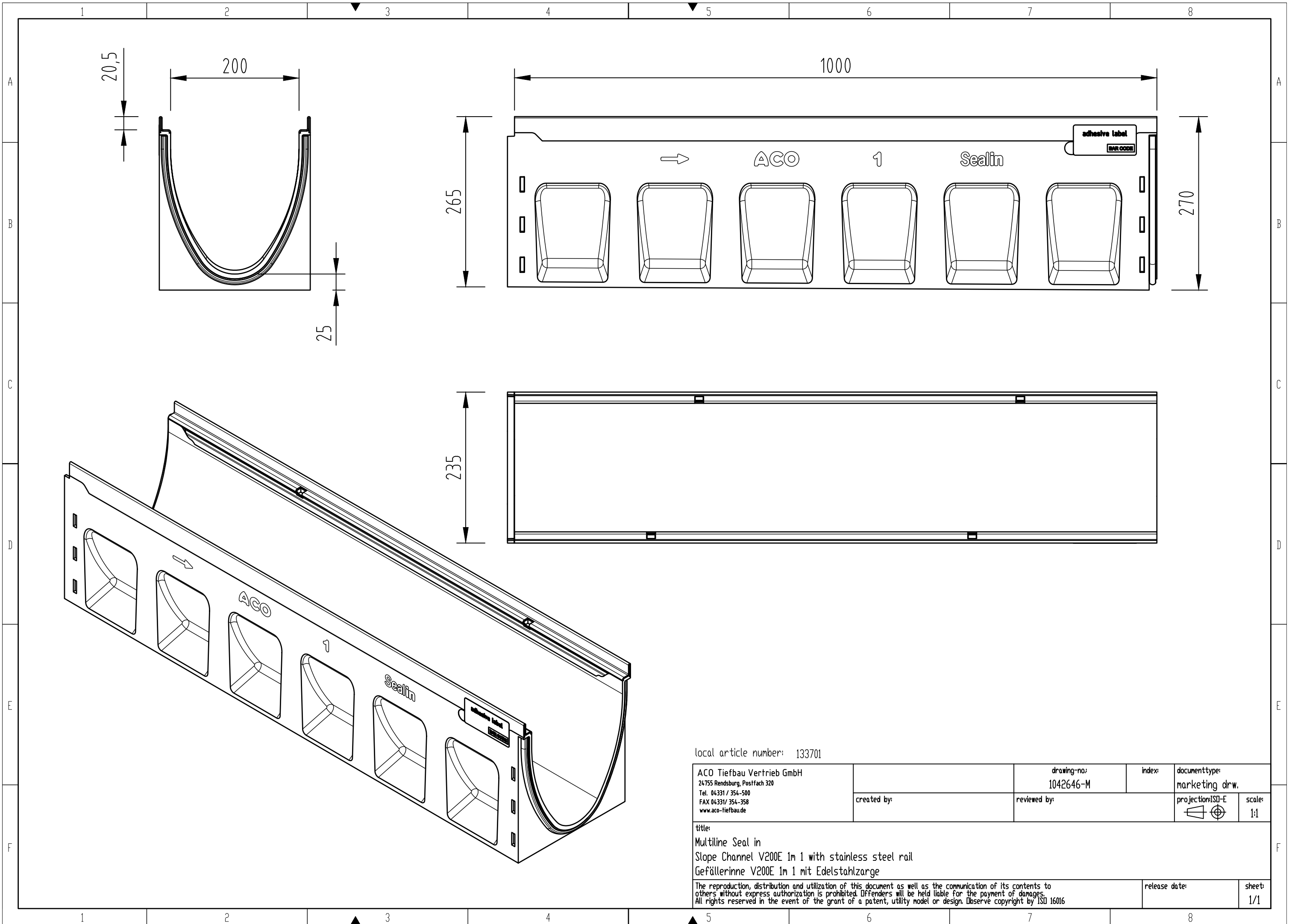

local article number: 133701

ACO Tiefbau Vertrieb GmbH 24755 Rendsburg, Postfach 320 Tel. 04331 / 354-500 FAX 04331/ 354-358 www.aco-tiefbau.de	drawing-no: 1042646-M	index:	documenttype: marketing drw.
	created by:	reviewed by:	projection:ISO-E 
title: Multiline Seal in Slope Channel V200E 1m 1 with stainless steel rail Gefällerinne V200E 1m 1 mit Edelstahlzarge			scale: 1:1
The reproduction, distribution and utilization of this document as well as the communication of its contents to others without express authorization is prohibited. Offenders will be held liable for the payment of damages. All rights reserved in the event of the grant of a patent, utility model or design. Observe copyright by ISO 16016			release date:
			sheet: 1/1

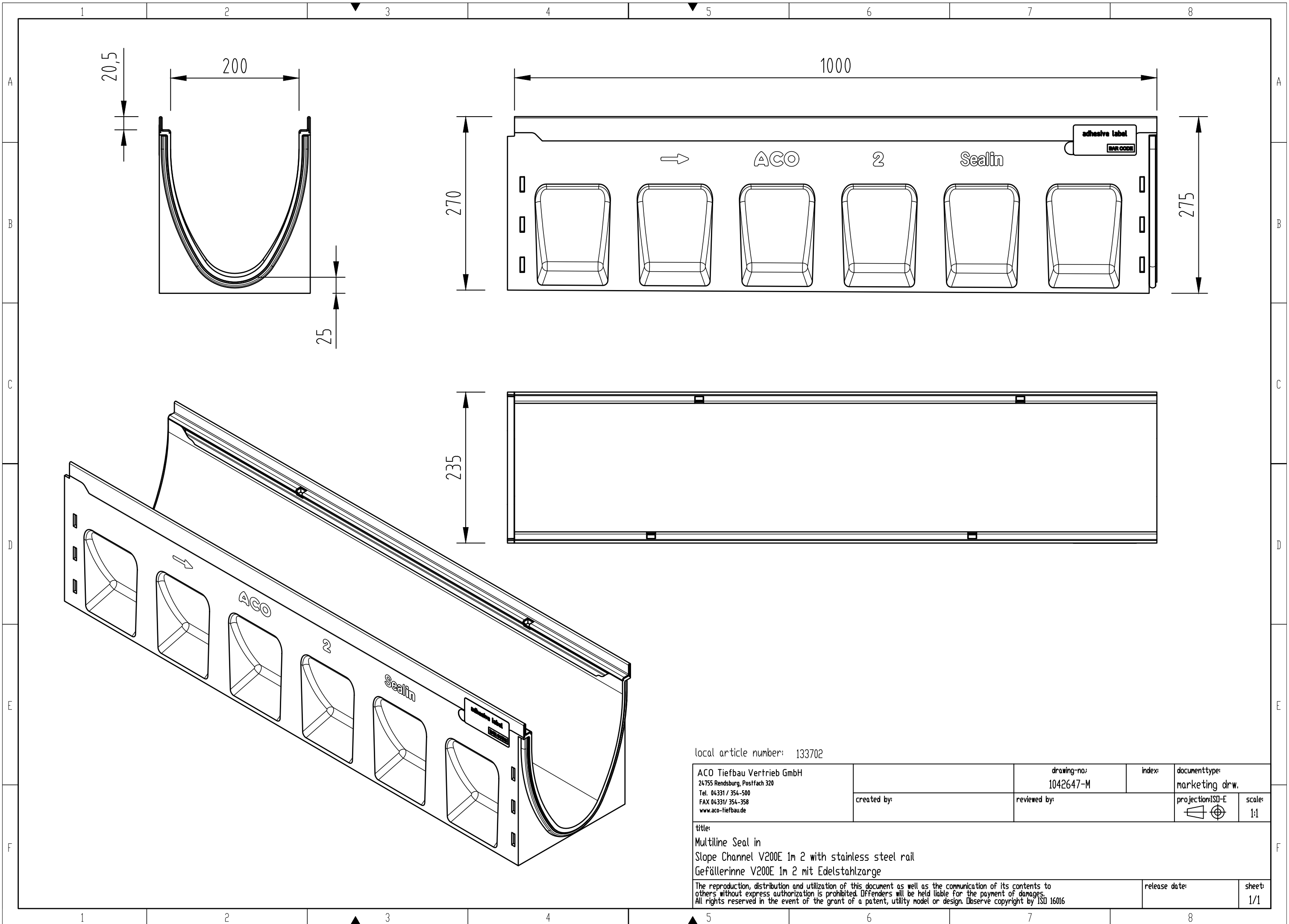

local article number: 133702

ACO Tiefbau Vertrieb GmbH 24755 Rendsburg, Postfach 320 Tel. 04331 / 354-500 FAX 04331/ 354-358 www.aco-tiefbau.de	drawing-no: 1042647-M	index:	documenttype: marketing drw.
	created by:	reviewed by:	projection:ISO-E scale: 1:1
title: Multiline Seal in Slope Channel V200E 1m 2 with stainless steel rail Gefällerinne V200E 1m 2 mit Edelstahlzarge			release date:
The reproduction, distribution and utilization of this document as well as the communication of its contents to others without express authorization is prohibited. Offenders will be held liable for the payment of damages. All rights reserved in the event of the grant of a patent, utility model or design. Observe copyright by ISO 16016			sheet: 1/1

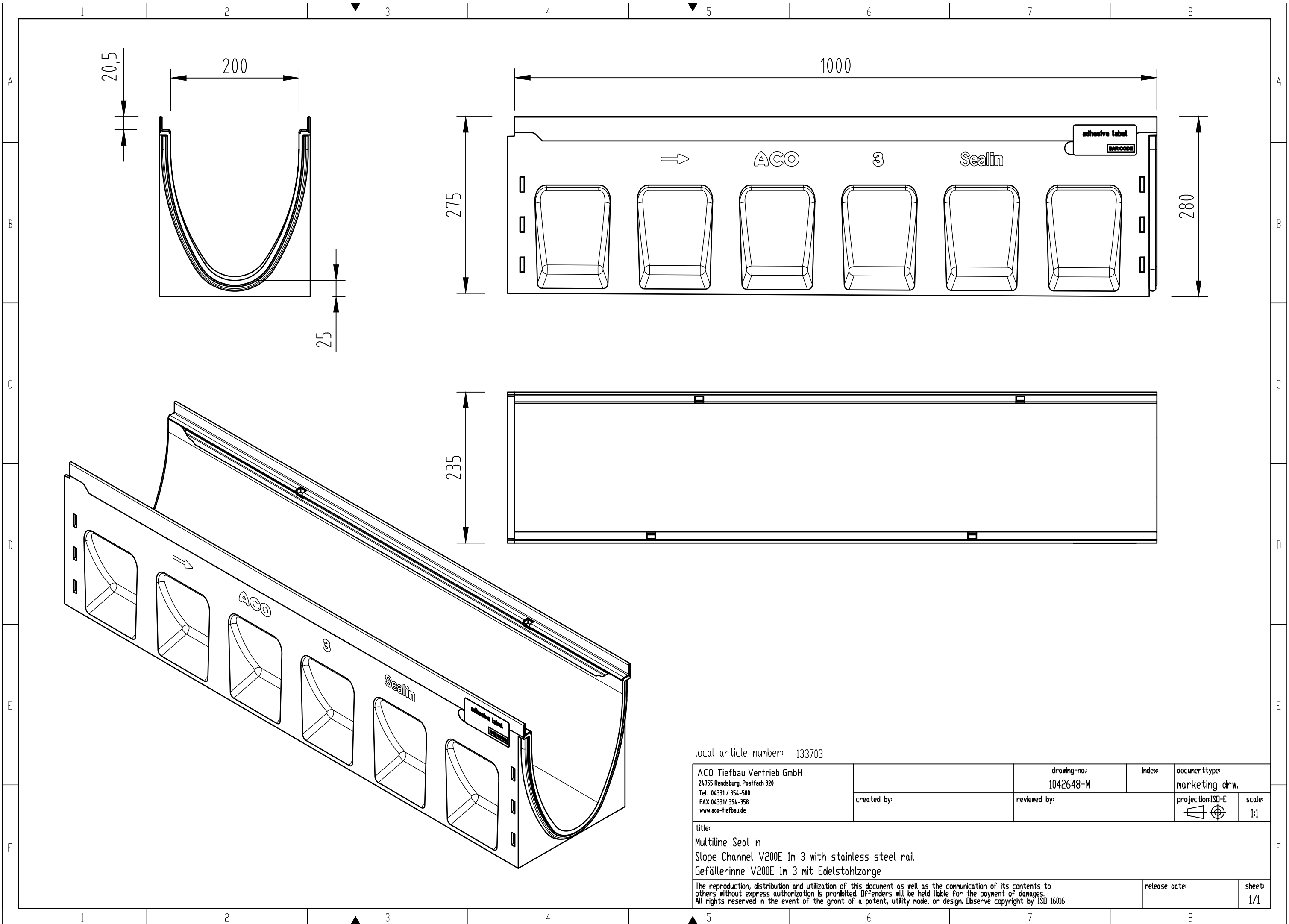

local article number: 133703

ACO Tiefbau Vertrieb GmbH 24755 Rendsburg, Postfach 320 Tel. 04331 / 354-500 FAX 04331/ 354-358 www.aco-tiefbau.de	drawing-no: 1042648-M	index:	documenttype: marketing drw.
	created by:	reviewed by:	projection:ISO-E 1:1
title: Multiline Seal in Slope Channel V200E 1m 3 with stainless steel rail Gefällerinne V200E 1m 3 mit Edelstahlzarge			release date:
The reproduction, distribution and utilization of this document as well as the communication of its contents to others without express authorization is prohibited. Offenders will be held liable for the payment of damages. All rights reserved in the event of the grant of a patent, utility model or design. Observe copyright by ISO 16016			sheet: 1/1

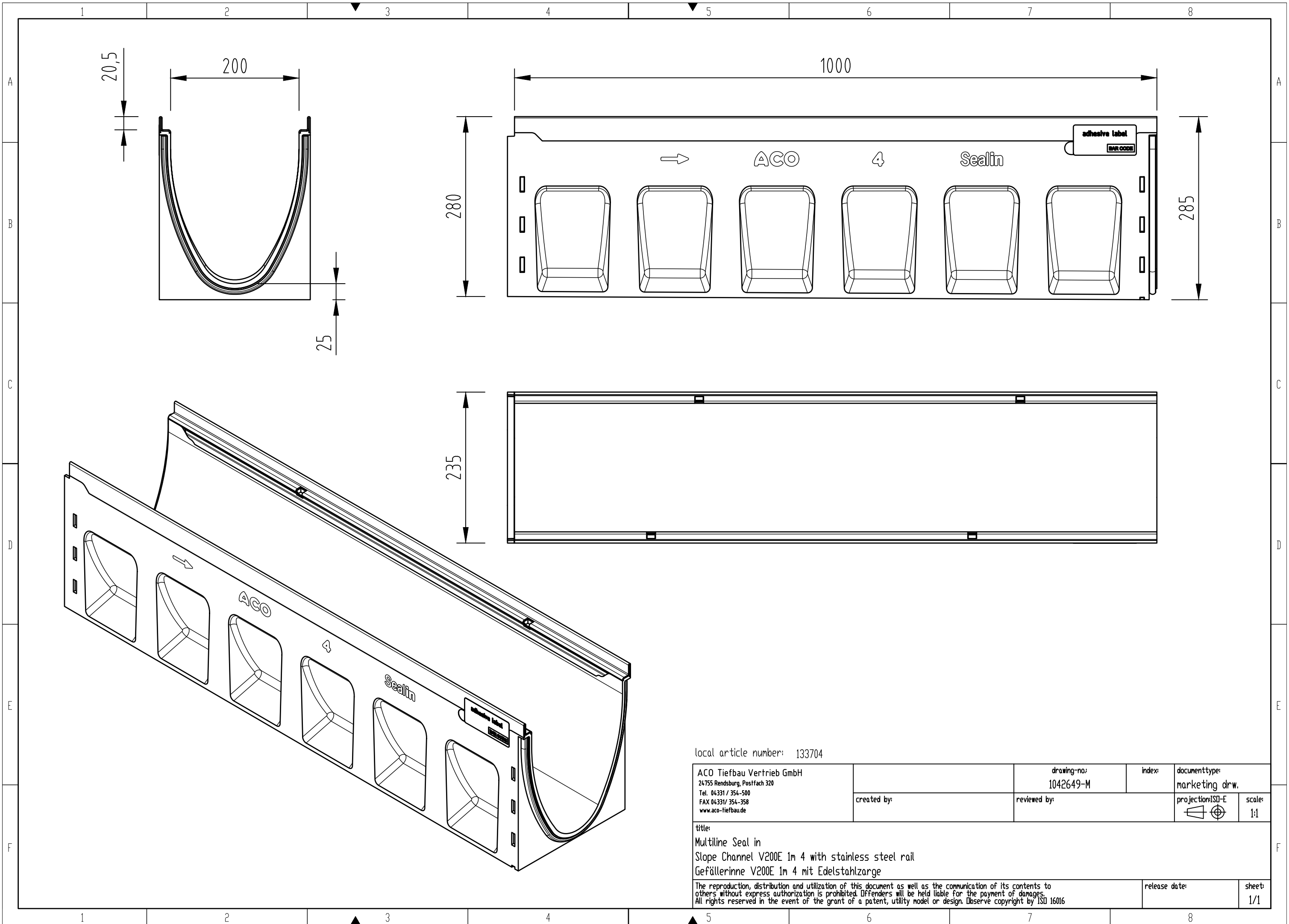

local article number: 133704

ACO Tiefbau Vertrieb GmbH 24755 Rendsburg, Postfach 320 Tel. 04331 / 354-500 FAX 04331/ 354-358 www.aco-tiefbau.de	drawing-no: 1042649-M	index:	documenttype: marketing drw.
	created by:	reviewed by:	projection:ISO-E 1:1
title: Multiline Seal in Slope Channel V200E 1m 4 with stainless steel rail Gefällerinne V200E 1m 4 mit Edelstahlzarge			release date:
The reproduction, distribution and utilization of this document as well as the communication of its contents to others without express authorization is prohibited. Offenders will be held liable for the payment of damages. All rights reserved in the event of the grant of a patent, utility model or design. Observe copyright by ISO 16016			sheet: 1/1

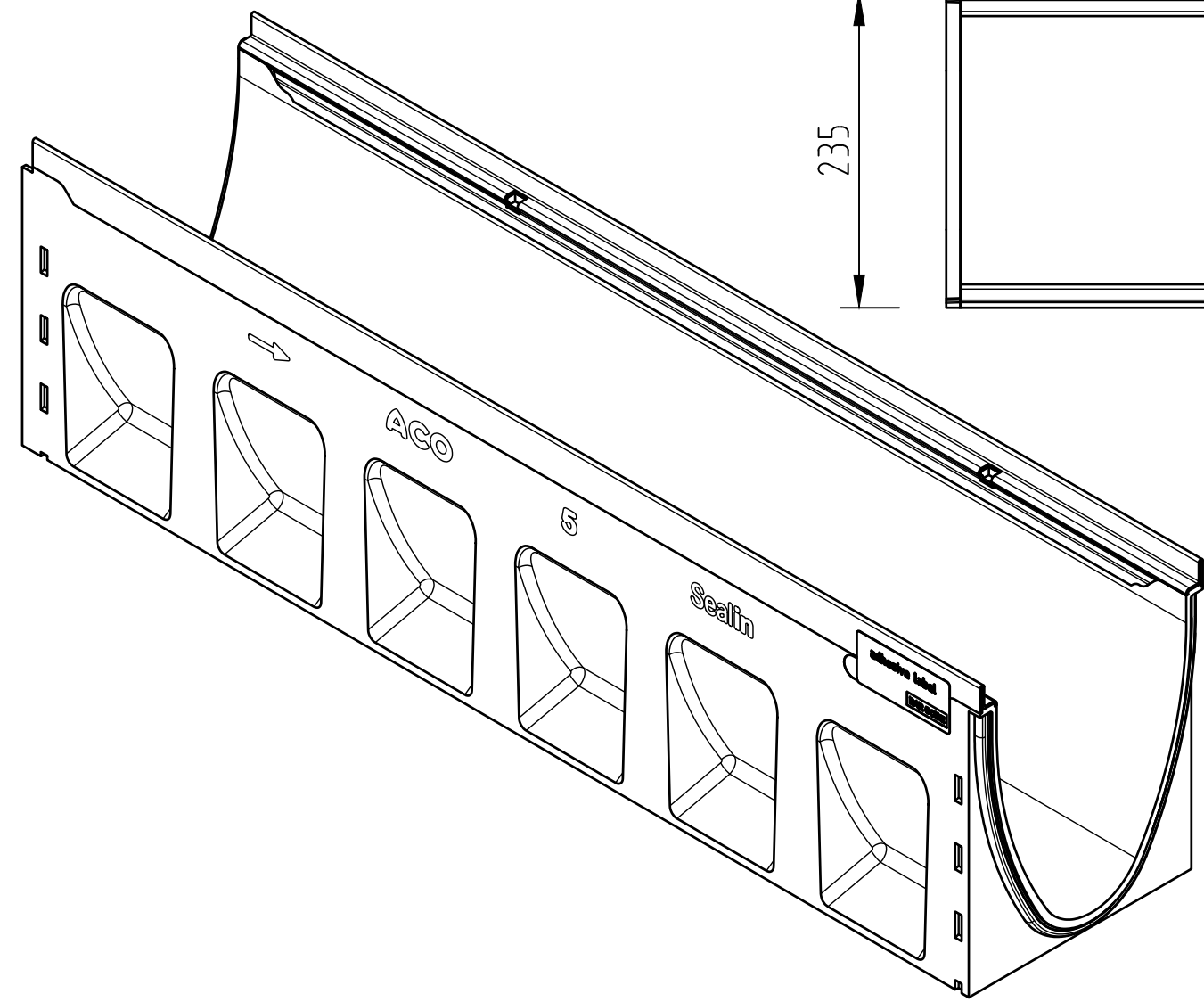
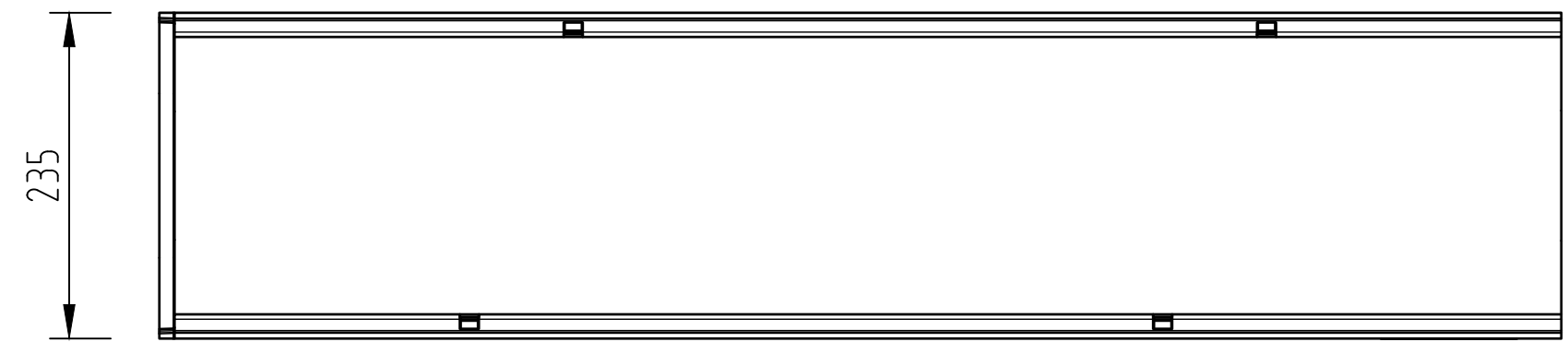
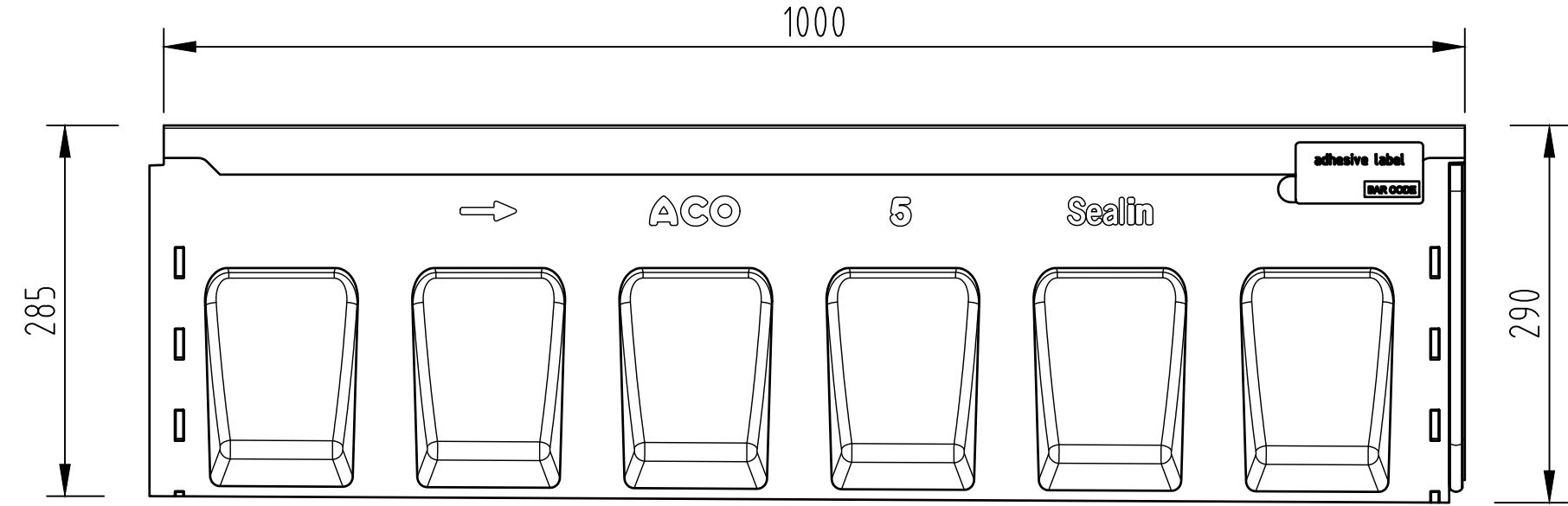
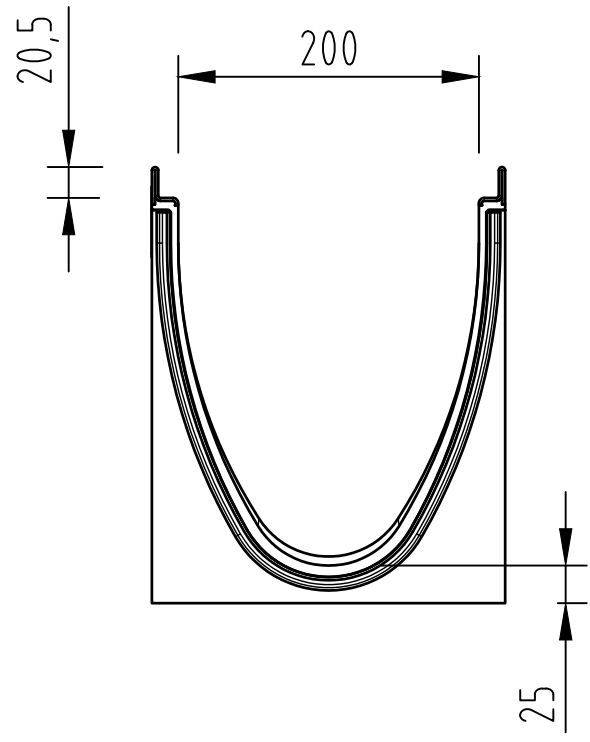
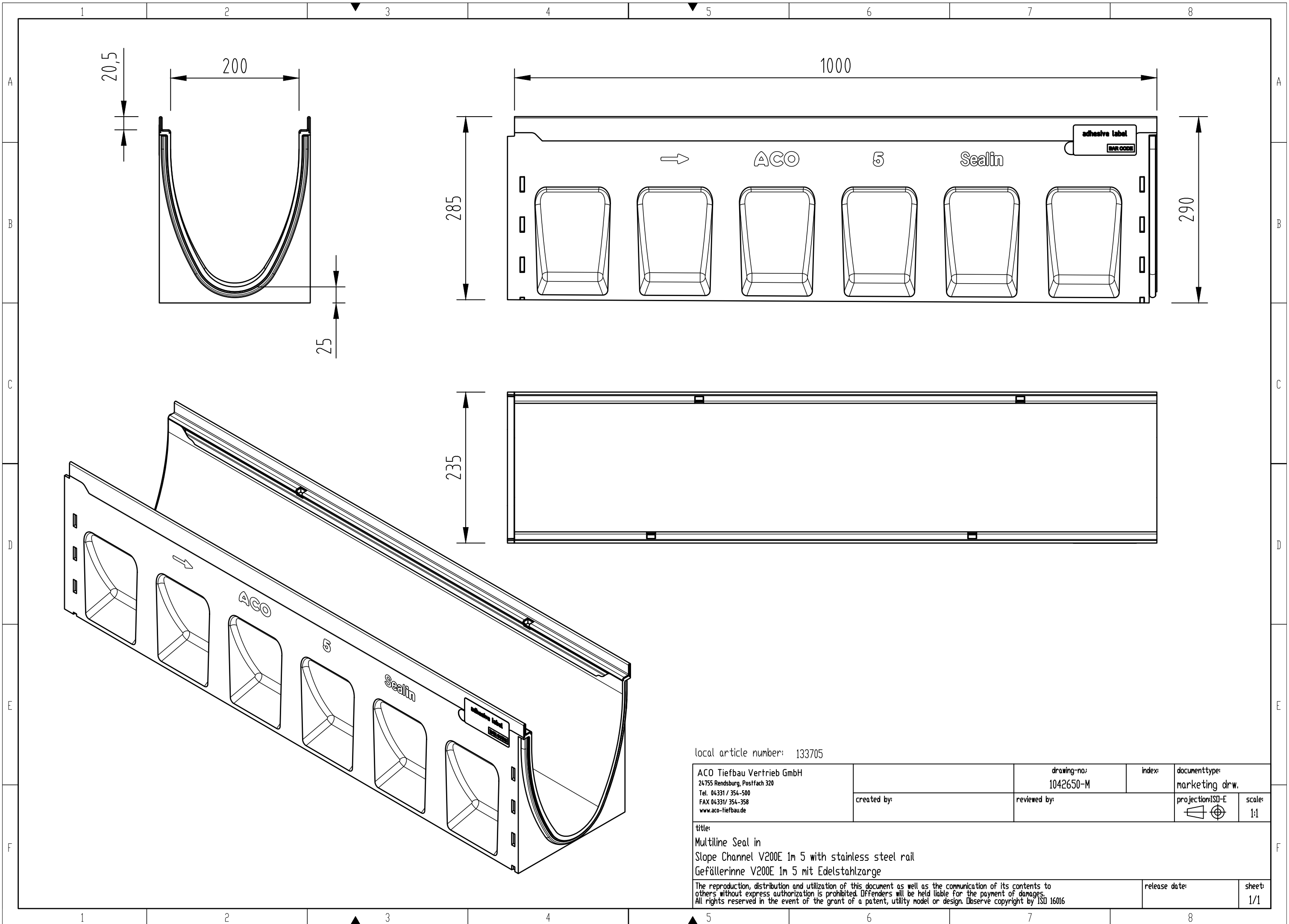

local article number: 133705

ACO Tiefbau Vertrieb GmbH 24755 Rendsburg, Postfach 320 Tel. 04331 / 354-500 FAX 04331/ 354-358 www.aco-tiefbau.de	drawing-no: 1042650-M	index:	documenttype: marketing drw.
	created by:	reviewed by:	projection:ISO-E scale: 1:1
title: Multiline Seal in Slope Channel V200E 1m 5 with stainless steel rail Gefällerinne V200E 1m 5 mit Edelstahlzarge			release date:
The reproduction, distribution and utilization of this document as well as the communication of its contents to others without express authorization is prohibited. Offenders will be held liable for the payment of damages. All rights reserved in the event of the grant of a patent, utility model or design. Observe copyright by ISO 16016			sheet: 1/1

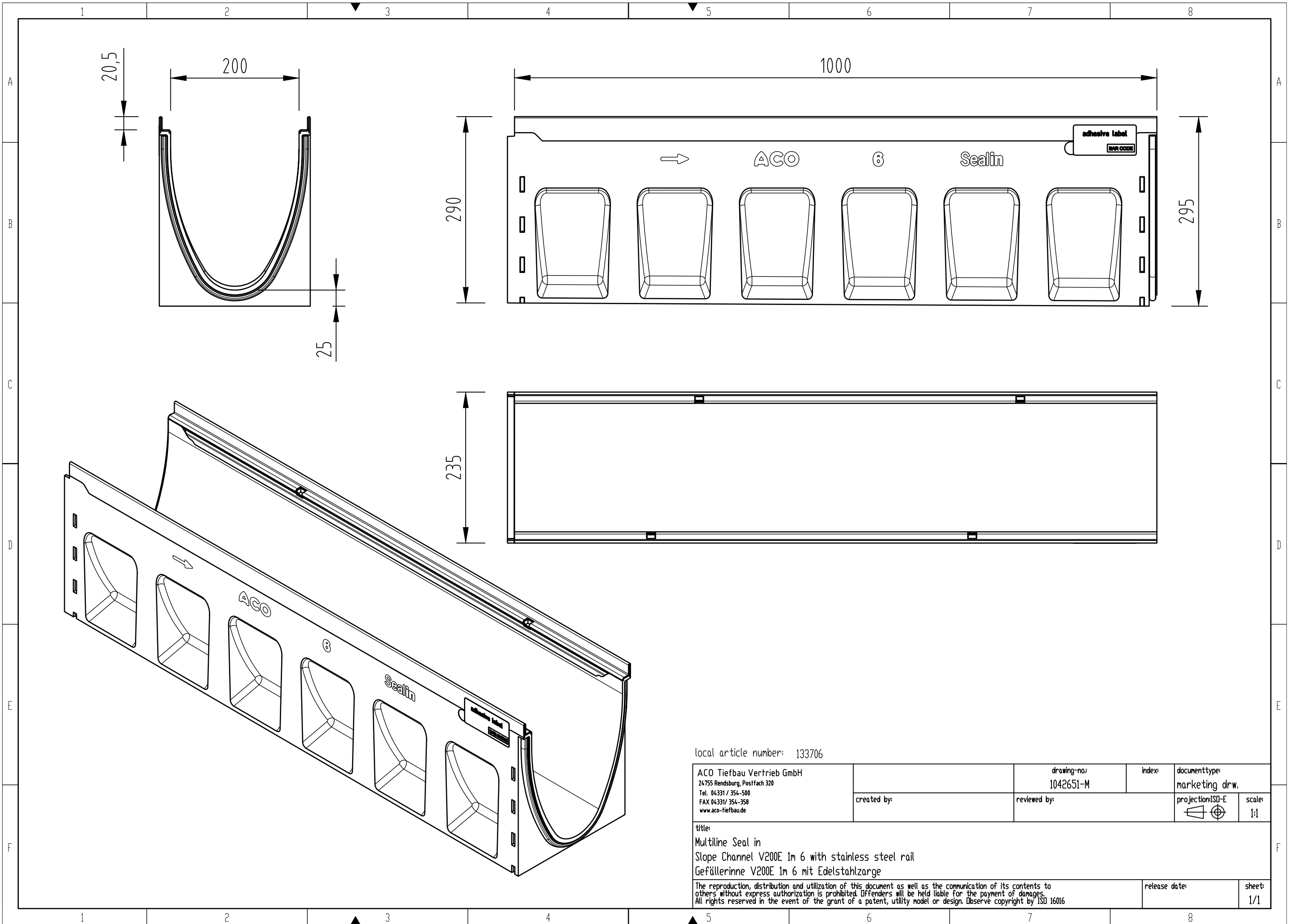

local article number: 133706

ACO Tiefbau Vertrieb GmbH 24755 Rendsburg, Postfach 320 Tel. 04331 / 354-500 FAX 04331/ 354-358 www.aco-tiefbau.de	drawing-no: 1042651-M	index:	documenttype: marketing drw.
	created by:	reviewed by:	projection:ISO-E scale: 1:1
title: Multiline Seal in Slope Channel V200E 1m 6 with stainless steel rail Gefällerrinne V200E 1m 6 mit Edelstahlzarge			release date:
The reproduction, distribution and utilization of this document as well as the communication of its contents to others without express authorization is prohibited. Offenders will be held liable for the payment of damages. All rights reserved in the event of the grant of a patent, utility model or design. Observe copyright by ISO 16016			sheet: 1/1

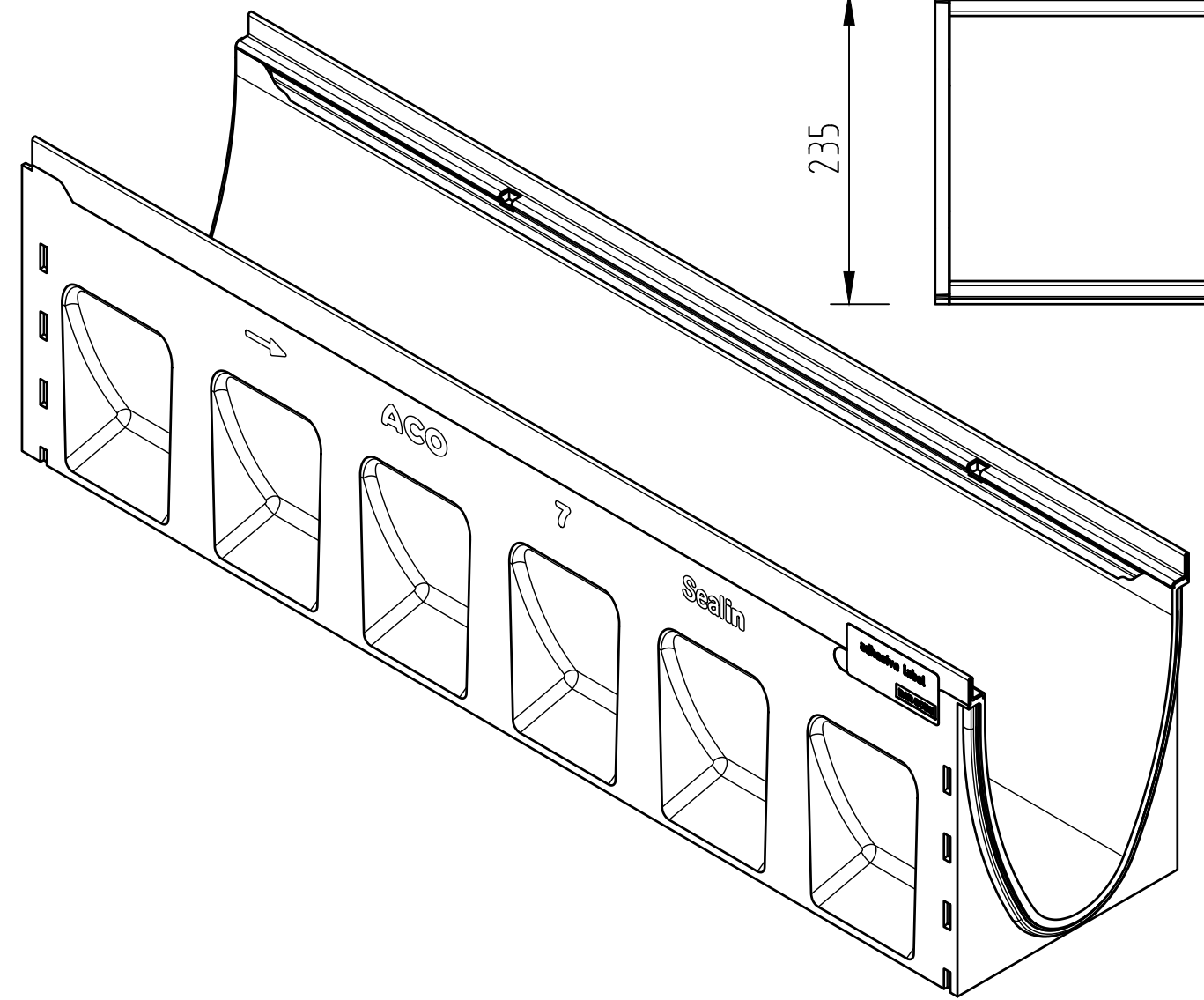
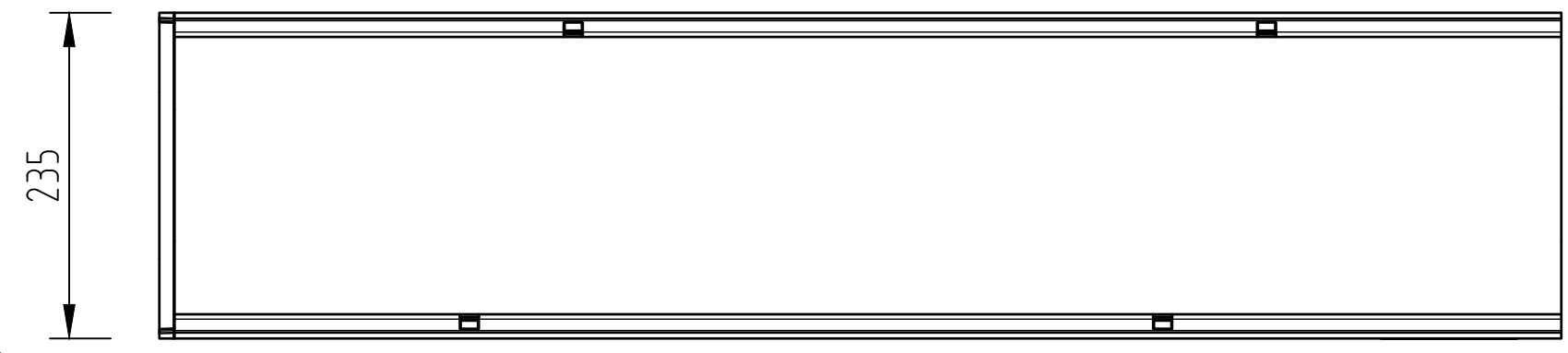
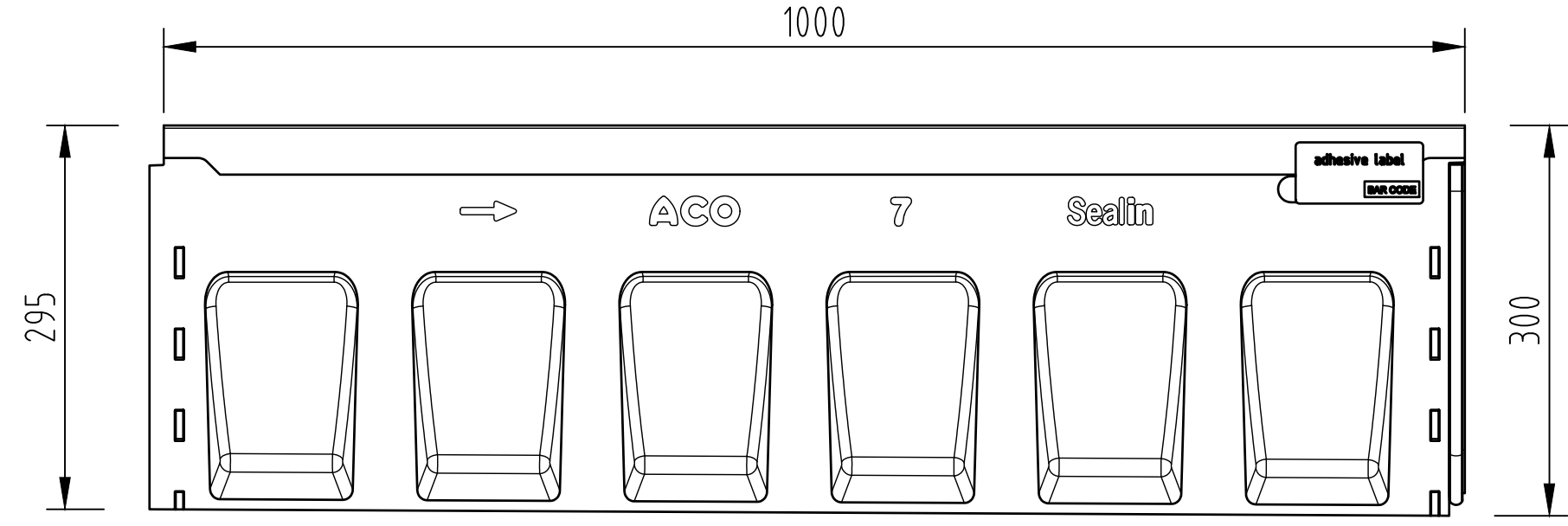
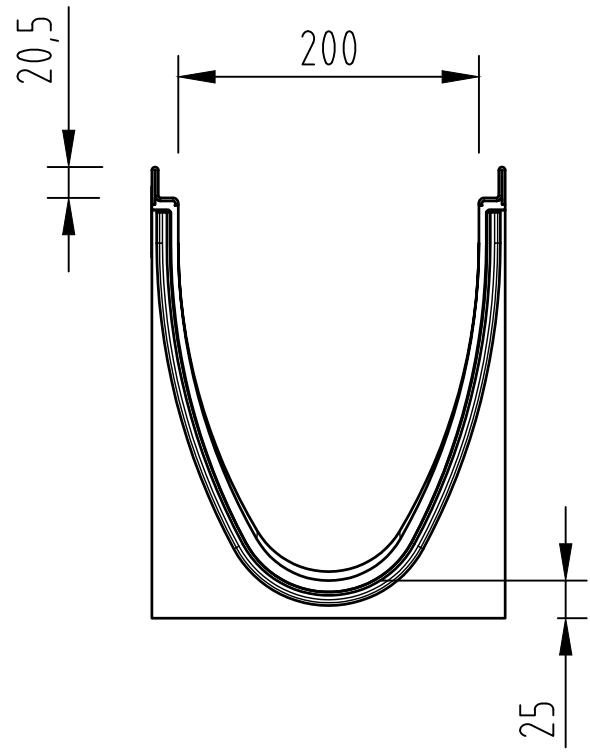
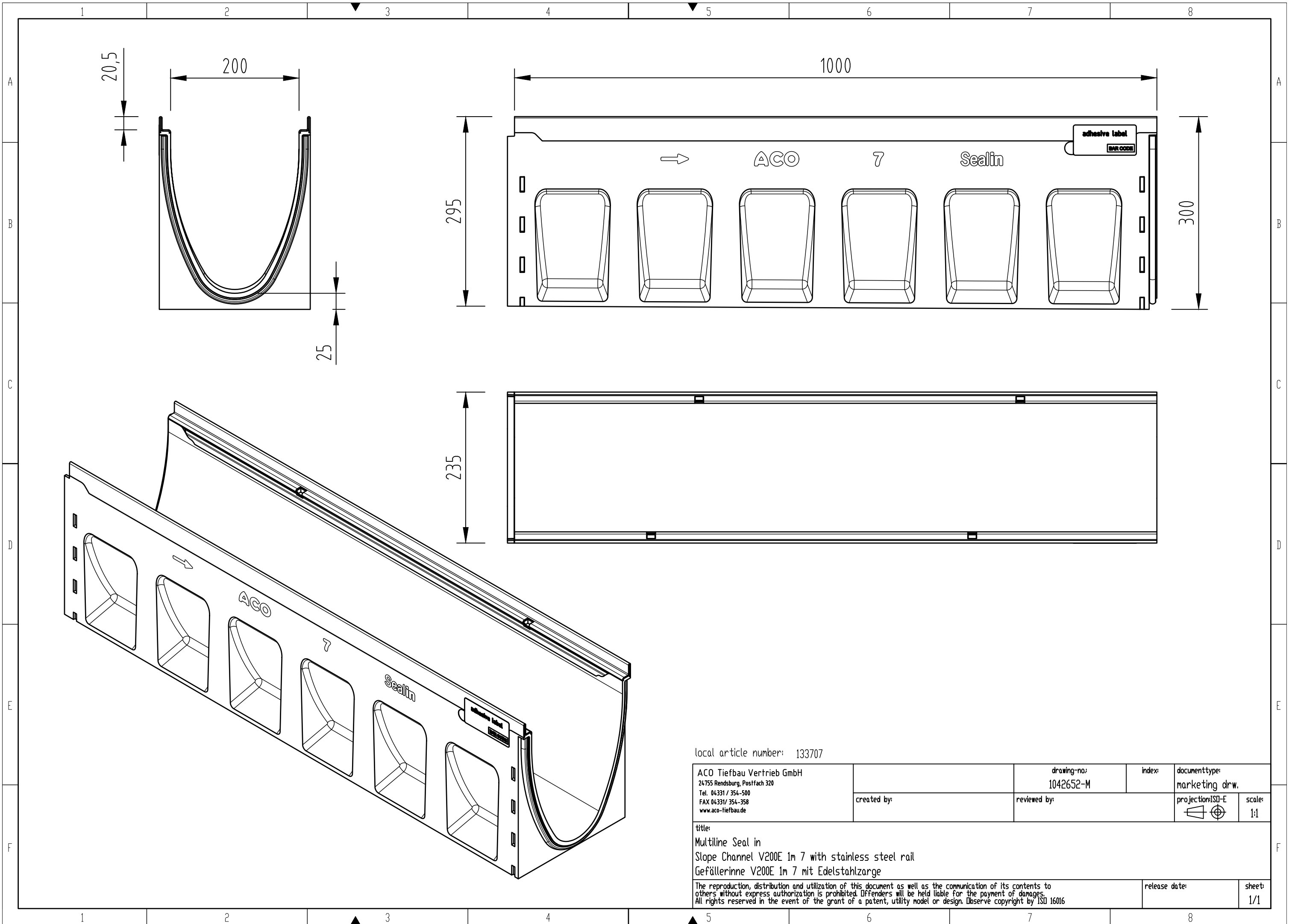

local article number: 133707

ACO Tiefbau Vertrieb GmbH 24755 Rendsburg, Postfach 320 Tel. 04331 / 354-500 FAX 04331/ 354-358 www.aco-tiefbau.de	drawing-no: 1042652-M	index:	documenttype: marketing drw.
	created by:	reviewed by:	projection:ISO-E scale: 1:1
title: Multiline Seal in Slope Channel V200E 1m 7 with stainless steel rail Gefällerinne V200E 1m 7 mit Edelstahlzarge			release date:
The reproduction, distribution and utilization of this document as well as the communication of its contents to others without express authorization is prohibited. Offenders will be held liable for the payment of damages. All rights reserved in the event of the grant of a patent, utility model or design. Observe copyright by ISO 16016			sheet: 1/1

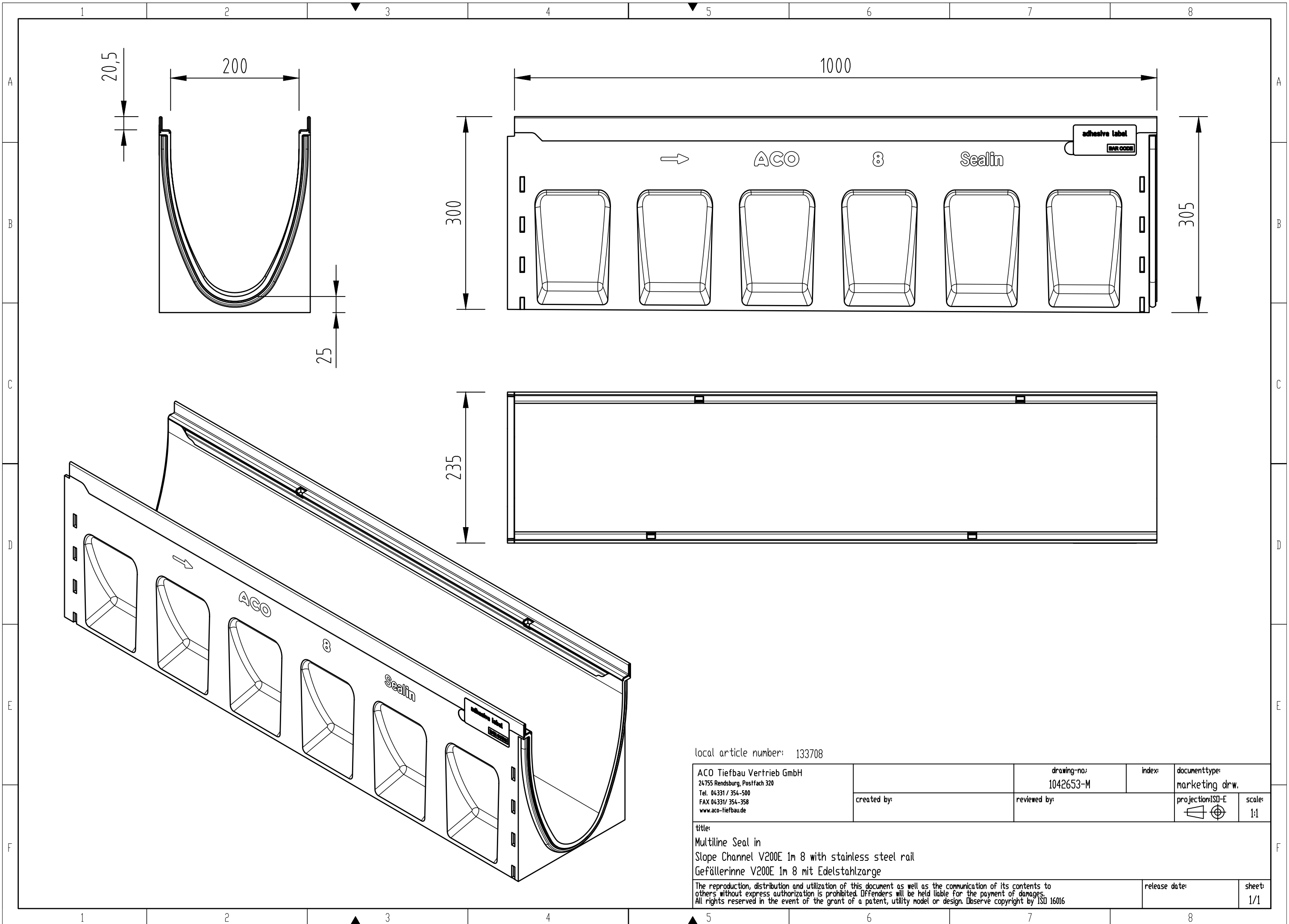

local article number: 133708

ACO Tiefbau Vertrieb GmbH 24755 Rendsburg, Postfach 320 Tel. 04331 / 354-500 FAX 04331/ 354-358 www.aco-tiefbau.de	drawing-no: 1042653-M	index:	documenttype: marketing drw.
	created by:	reviewed by:	projection:ISO-E 1:1
title: Multiline Seal in Slope Channel V200E 1m 8 with stainless steel rail Gefällerinne V200E 1m 8 mit Edelstahlzarge			release date:
The reproduction, distribution and utilization of this document as well as the communication of its contents to others without express authorization is prohibited. Offenders will be held liable for the payment of damages. All rights reserved in the event of the grant of a patent, utility model or design. Observe copyright by ISO 16016			sheet: 1/1

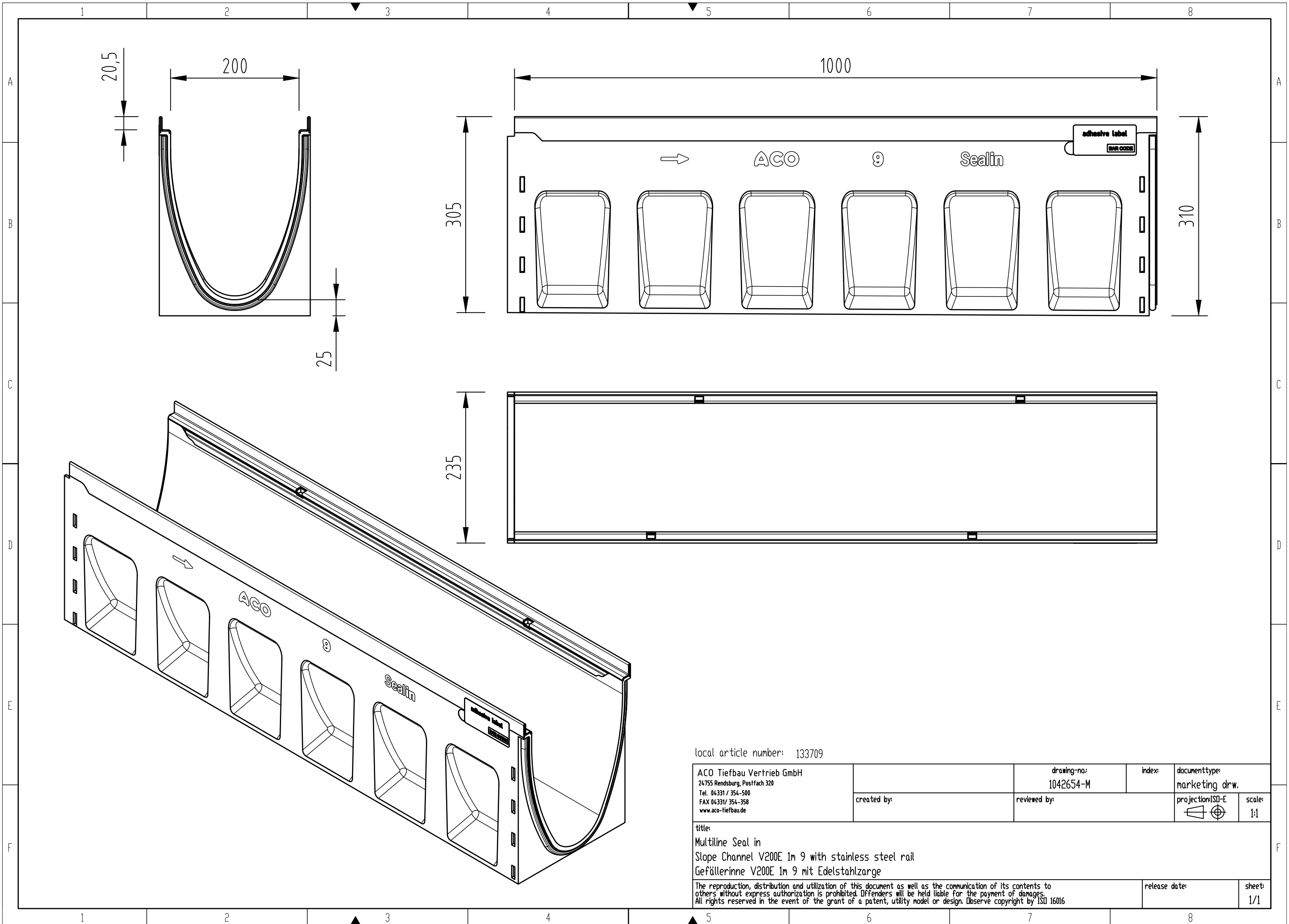

local article number: 133709

ACO Tiefbau Vertrieb GmbH 24755 Rendsburg, Postfach 320 Tel. 04331 / 354-500 FAX 04331/ 354-358 www.aco-tiefbau.de	drawing-no: 1042654-M	index:	documenttype: marketing drw.
	created by:	reviewed by:	projection:ISO-E scale: 1:1
title: Multiline Seal in Slope Channel V200E 1m 9 with stainless steel rail Gefällerinne V200E 1m 9 mit Edelstahlzarge			release date:
The reproduction, distribution and utilization of this document as well as the communication of its contents to others without express authorization is prohibited. Offenders will be held liable for the payment of damages. All rights reserved in the event of the grant of a patent, utility model or design. Observe copyright by ISO 16016			sheet: 1/1

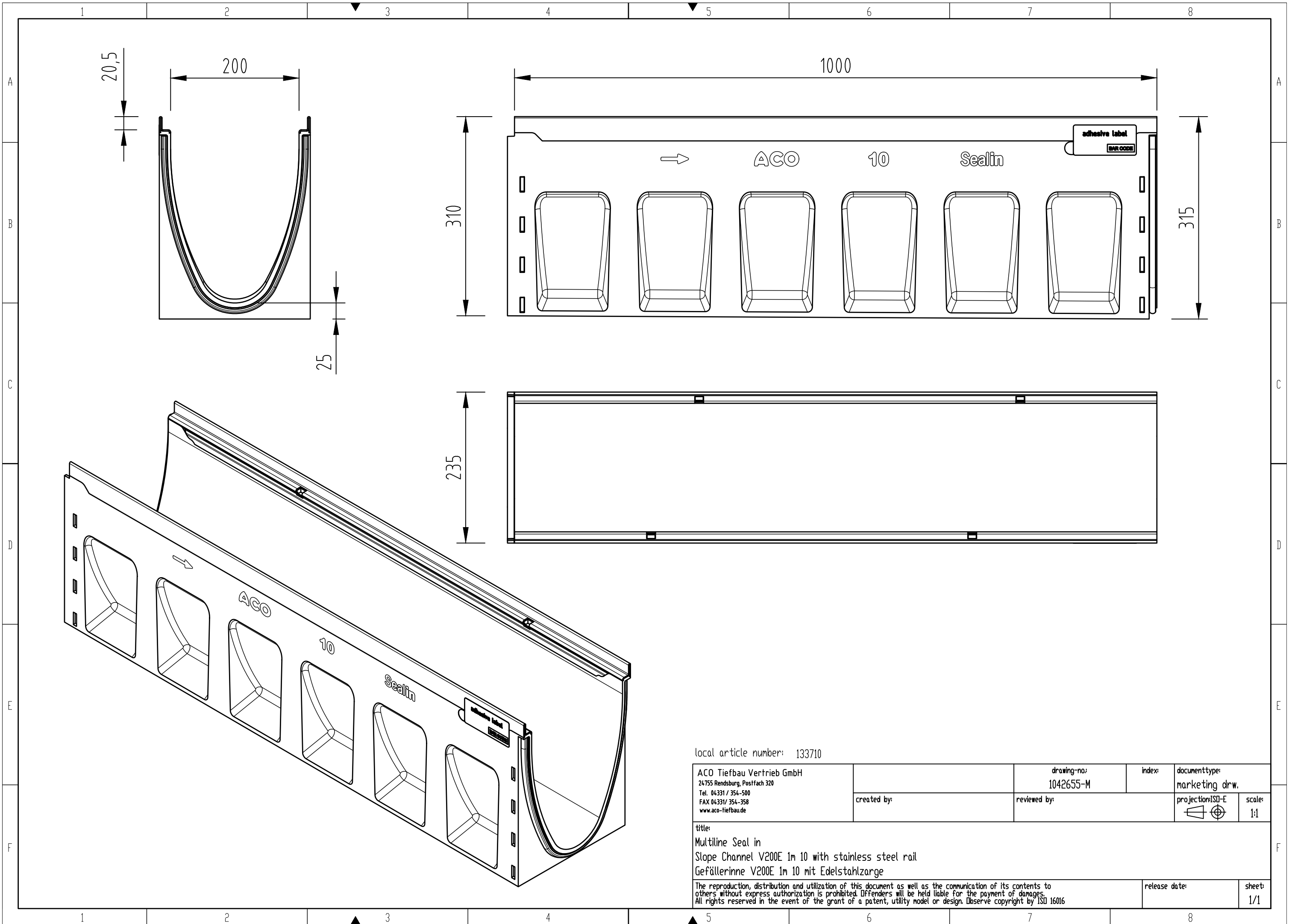

local article number: 133710

ACO Tiefbau Vertrieb GmbH 24755 Rendsburg, Postfach 320 Tel. 04331 / 354-500 FAX 04331/ 354-358 www.aco-tiefbau.de	drawing-no: 1042655-M	index:	documenttype: marketing drw.
	created by:	reviewed by:	projection:ISO-E 1:1
title: Multiline Seal in Slope Channel V200E 1m 10 with stainless steel rail Gefällerrinne V200E 1m 10 mit Edelstahlzarge			release date:
The reproduction, distribution and utilization of this document as well as the communication of its contents to others without express authorization is prohibited. Offenders will be held liable for the payment of damages. All rights reserved in the event of the grant of a patent, utility model or design. Observe copyright by ISO 16016			sheet: 1/1