

434x250cm

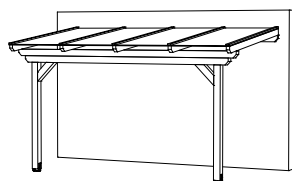

4018211 201259

541x250cm

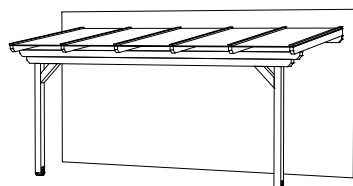

4018211 201334

648x250cm

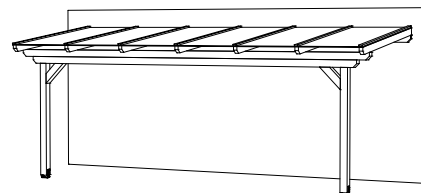

4018211 201419

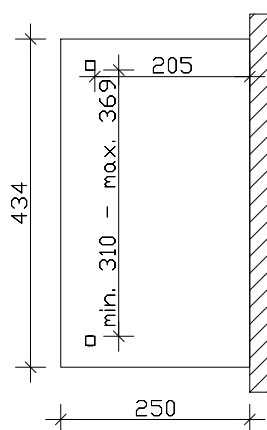

Grundriss

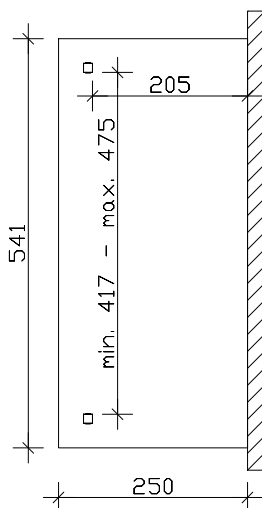

Grundriss

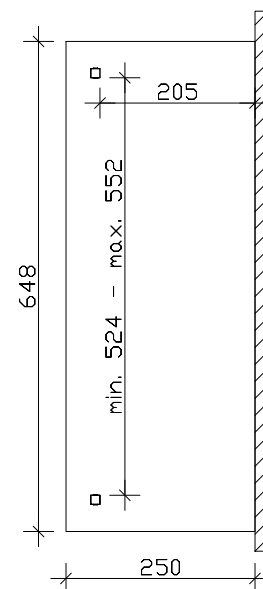

Grundriss

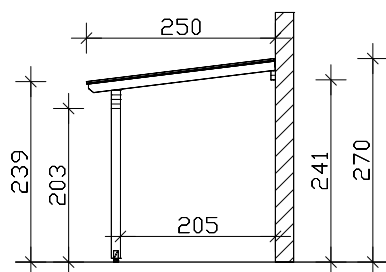

Seitenansicht

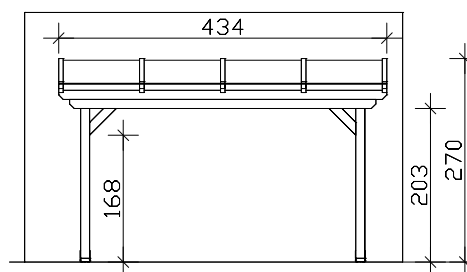

Frontansicht

M 1:100

"Ancona" Terrassenüberdachung 434cm / 541cm / 648cm x 250cm

Datenblatt / Baubeschreibung

Holzart / Eisenteile	Leimholz, unbehandelt / verzinkt
Pfosten	2 Stück 12x12x198cm
Dacheindeckung	Polycarbonat Doppelstegplatten 16mm (transparent)
Schneelast	sk = 2,00kN/m²
Breite x Tiefe	434cm / 541cm / 648cm x 250cm (überdachte Fläche)
Gesamthöhe / Durchgang	239-270cm / 203cm (inkl. Abstand zum Boden, Aufschraubstütze = 5cm)
Fläche (umb.Raum)	10,85m² (27,61m³) / 13,53m² (34,43m³) / 16,20m² (41,23m³)
Dachneigung	7°
Verpackungseinheit	B x L x H 120x435-650x45-48cm / Gewicht 225/265/305kg
Inklusive	Montagematerial, Aufschraubstützen, Kopfbänder, Aufbauanleitung (ohne Dübel für Wandbefestigung, ohne Wandabschlussprofile)

434x300cm

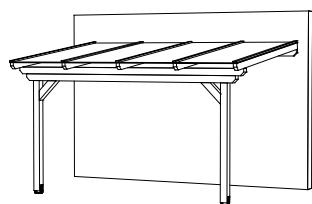

4018211 201273

541x300cm

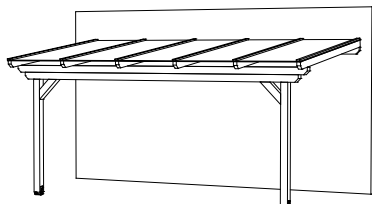

4018211 201358

648x300cm

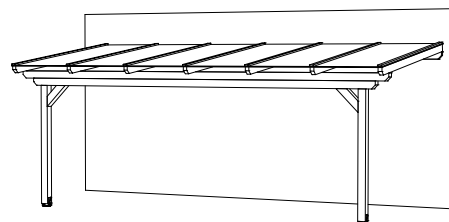

4018211 201433

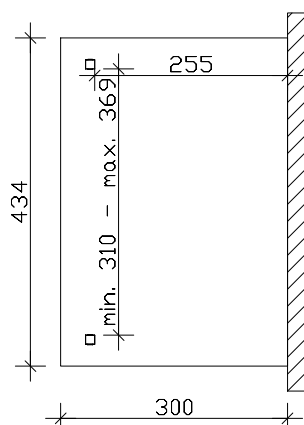

Grundriss

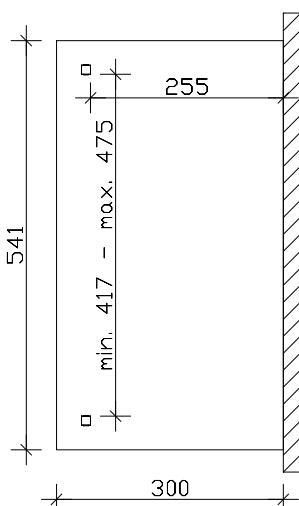

Grundriss

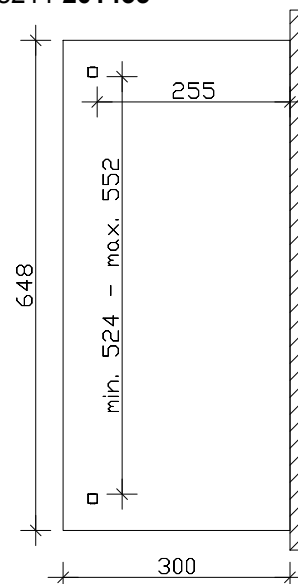

Grundriss

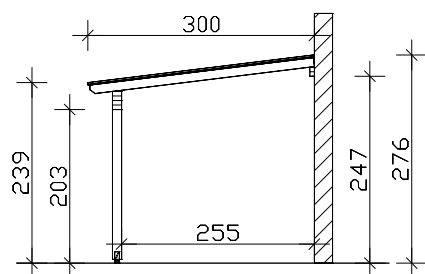

Seitenansicht

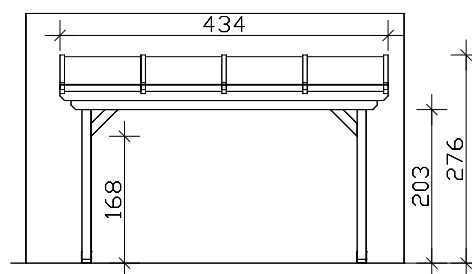

Frontansicht

M 1:100

"Ancona" Terrassenüberdachung 434cm / 541cm / 648cm x 300cm

Datenblatt / Baubeschreibung

Holzart / Eisenteile	Leimholz, unbehandelt / verzinkt
Pfosten	2 Stück 12x12x198cm
Dacheindeckung	Polycarbonat Doppelstegplatten 16mm (transparent)
Schneelast	sk = 1,65kN/m²
Breite x Tiefe	434cm / 541cm / 648cm x 300cm (überdachte Fläche)
Gesamthöhe / Durchgang	239-276cm / 203cm (inkl. Abstand zum Boden, Aufschraubstütze = 5cm)
Fläche (umb.Raum)	13,02m² (33,53m³) / 16,23m² (41,79m³) / 19,44m² (50,06m³)
Dachneigung	7°
Verpackungseinheit	B x L x H 120x435-650x45-48cm / Gewicht 240/285/330kg
Inklusive	Montagematerial, Aufschraubstützen, Kopfbänder, Aufbauanleitung (ohne Dübel für Wandbefestigung, ohne Wandabschlussprofile)

434x350cm

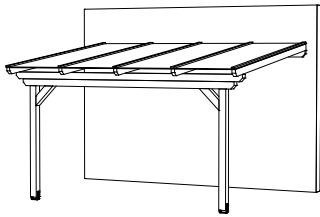

4018211 201297

541x350cm

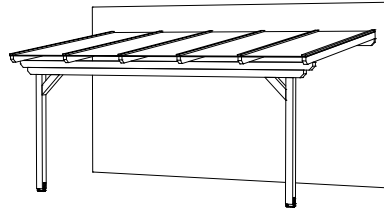

4018211 201372

648x350cm

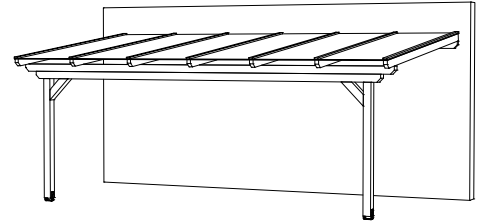

4018211 201457

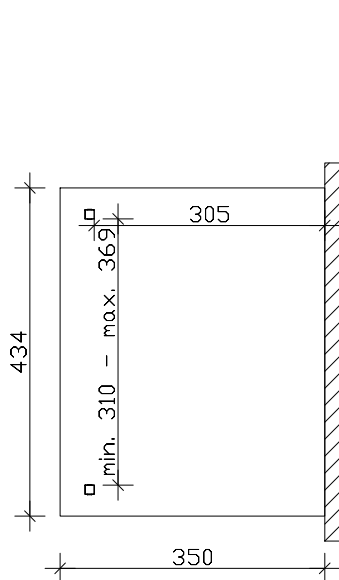

Grundriss

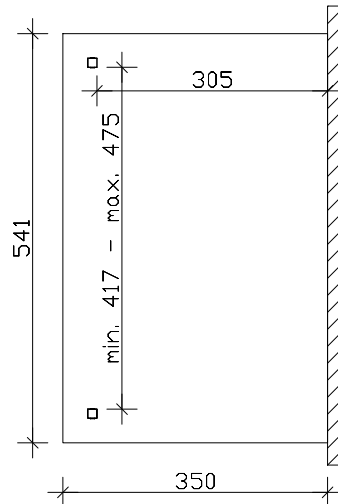

Grundriss

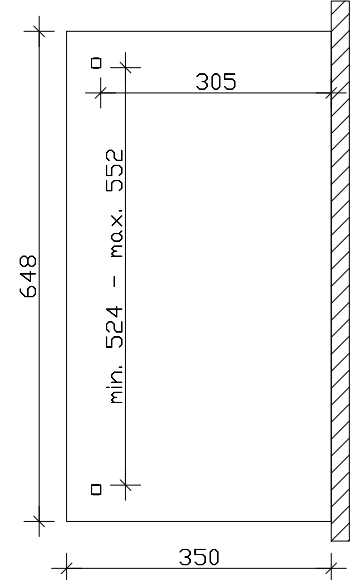

Grundriss

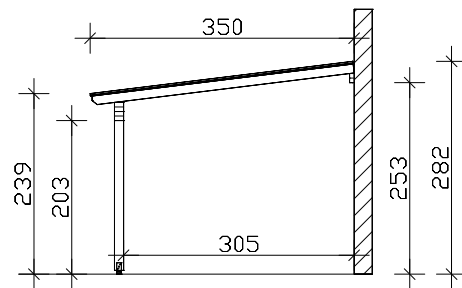

Seitenansicht

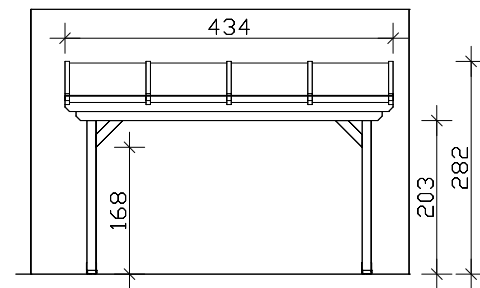

Frontansicht

M 1:100

"Ancona" Terrassenüberdachung 434cm / 541cm / 648cm x 350cm

Datenblatt / Baubeschreibung

Holzart / Eisenteile	Leimholz, unbehandelt / verzinkt
Pfosten	2 Stück 12x12x198cm
Dacheindeckung	Polycarbonat Doppelstegplatten 16mm (transparent)
Schneelast	sk = 1,00kN/m²
Breite x Tiefe	434cm / 541cm / 648cm x 350cm (überdachte Fläche)
Gesamthöhe / Durchgang	239-282cm / 203cm (inkl. Abstand zum Boden, Aufschraubstütze = 5cm)
Fläche (umb.Raum)	15,19m² (39,57m³) / 18,94m² (49,34m³) / 22,68m² (59,08m³)
Dachneigung	7°
Verpackungseinheit	B x L x H 120x435-650x45-48cm / Gewicht 255/302,5/350kg
Inklusive	Montagematerial, Aufschraubstützen, Kopfbänder, Aufbauanleitung (ohne Dübel für Wandbefestigung, ohne Wandabschlussprofile)

434x400cm

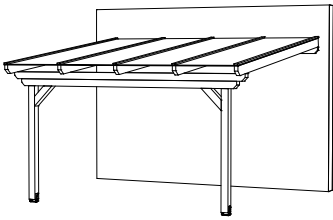

4018211 201310

541x400cm

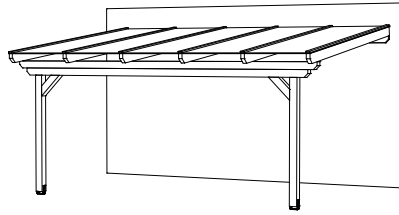

4018211 201396

648x400cm

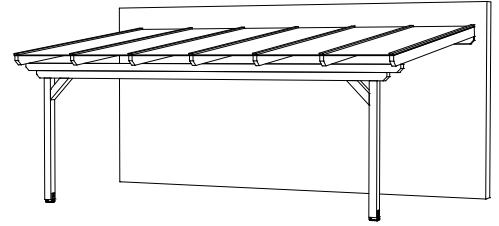

4018211 201471

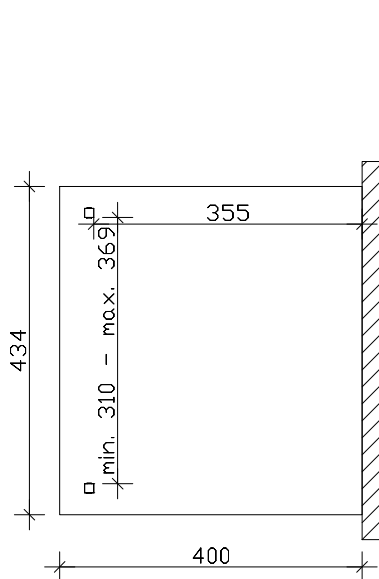

Grundriss

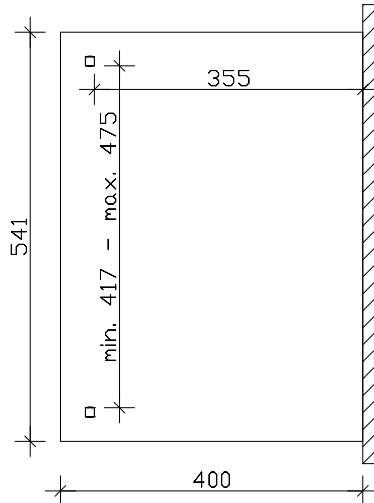

Grundriss

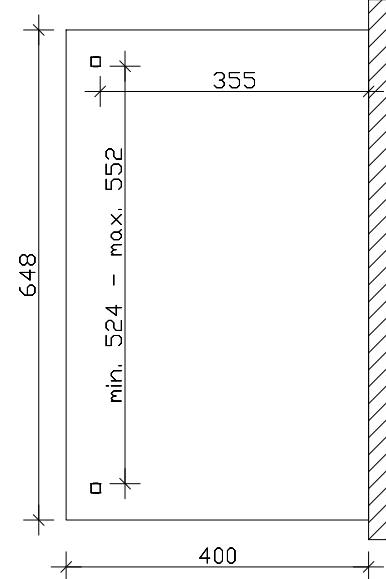

Grundriss

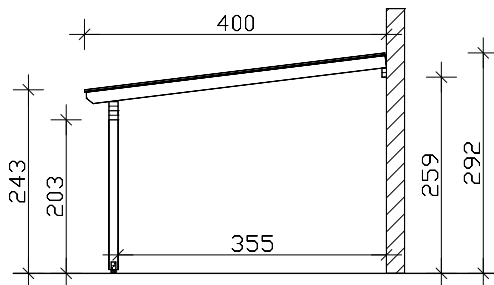

Seitenansicht

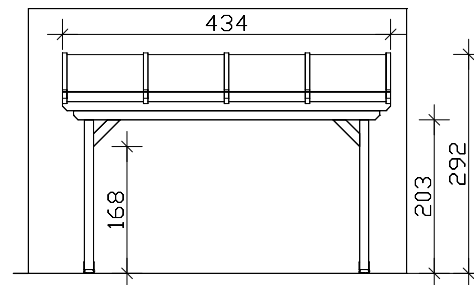

Frontansicht

M 1:100

"Ancona" Terrassenüberdachung 434cm / 541cm / 648cm x 400cm

Datenblatt / Baubeschreibung

Holzart / Eisenteile	Leimholz, unbehandelt / verzinkt
Pfosten	2 Stück 12x12x198cm
Dacheindeckung	Polycarbonat Doppelstegplatten 16mm (transparent)
Schneelast	sk = 1,45kN/m²
Breite x Tiefe	434cm / 541cm / 648cm x 400cm (überdachte Fläche)
Gesamthöhe / Durchgang	243-292cm / 203cm (inkl. Abstand zum Boden, Aufschraubstütze = 5cm)
Fläche (umb.Raum)	17,36m² (46,43m³) / 21,64m² (57,89m³) / 25,92m² (69,34m³)
Dachneigung	7°
Verpackungseinheit	B x L x H 120x435-650x45-48cm / Gewicht 305/362,5/420kg
Inklusive	Montagematerial, Aufschraubstützen, Kopfbänder, Aufbauanleitung (ohne Dübel für Wandbefestigung, ohne Wandabschlussprofile)