

Technische Daten

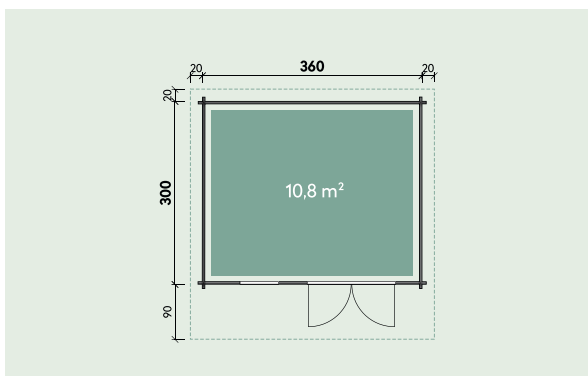

Artikelnummer:

234 100



Kontrolliert durch:

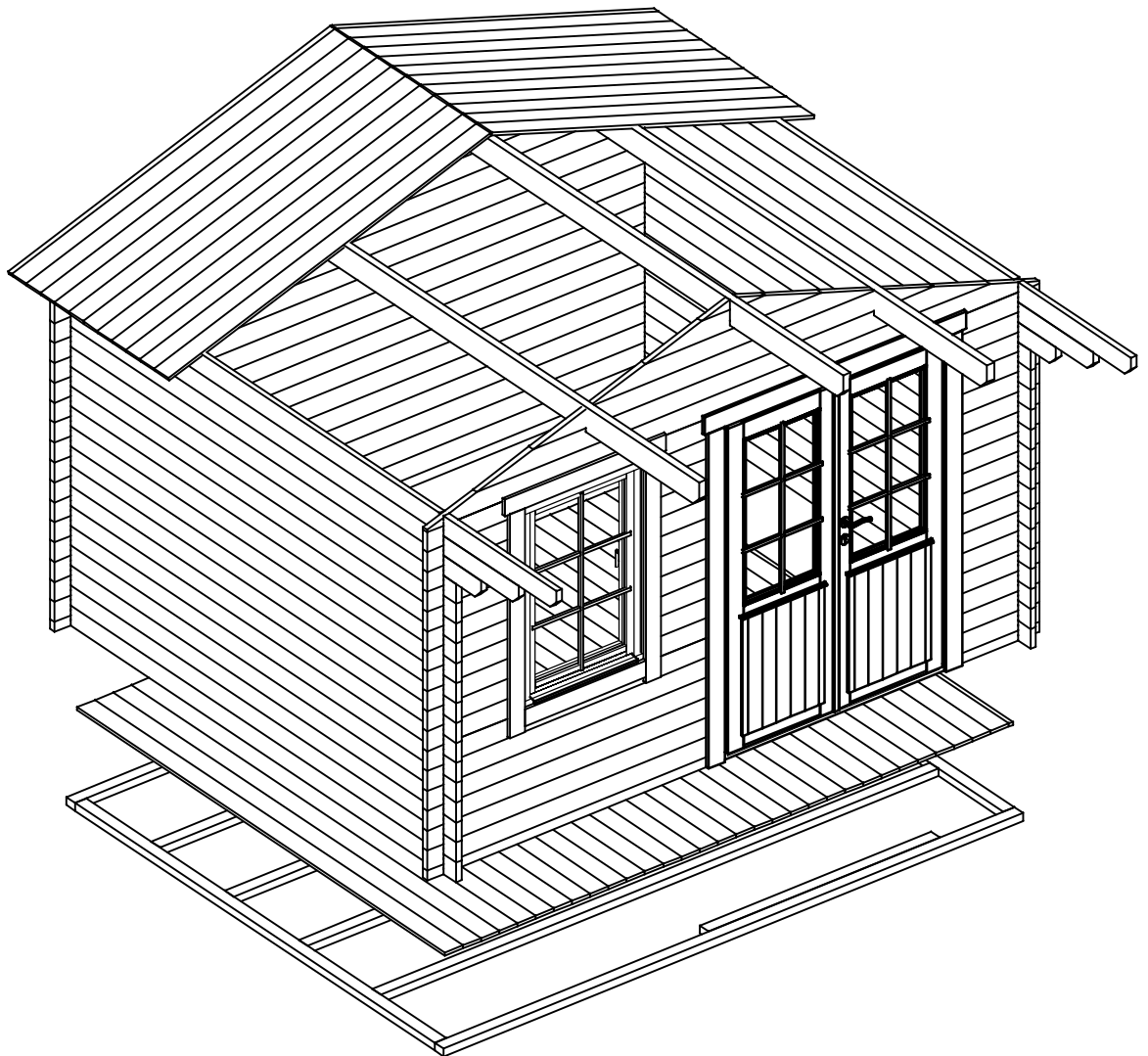

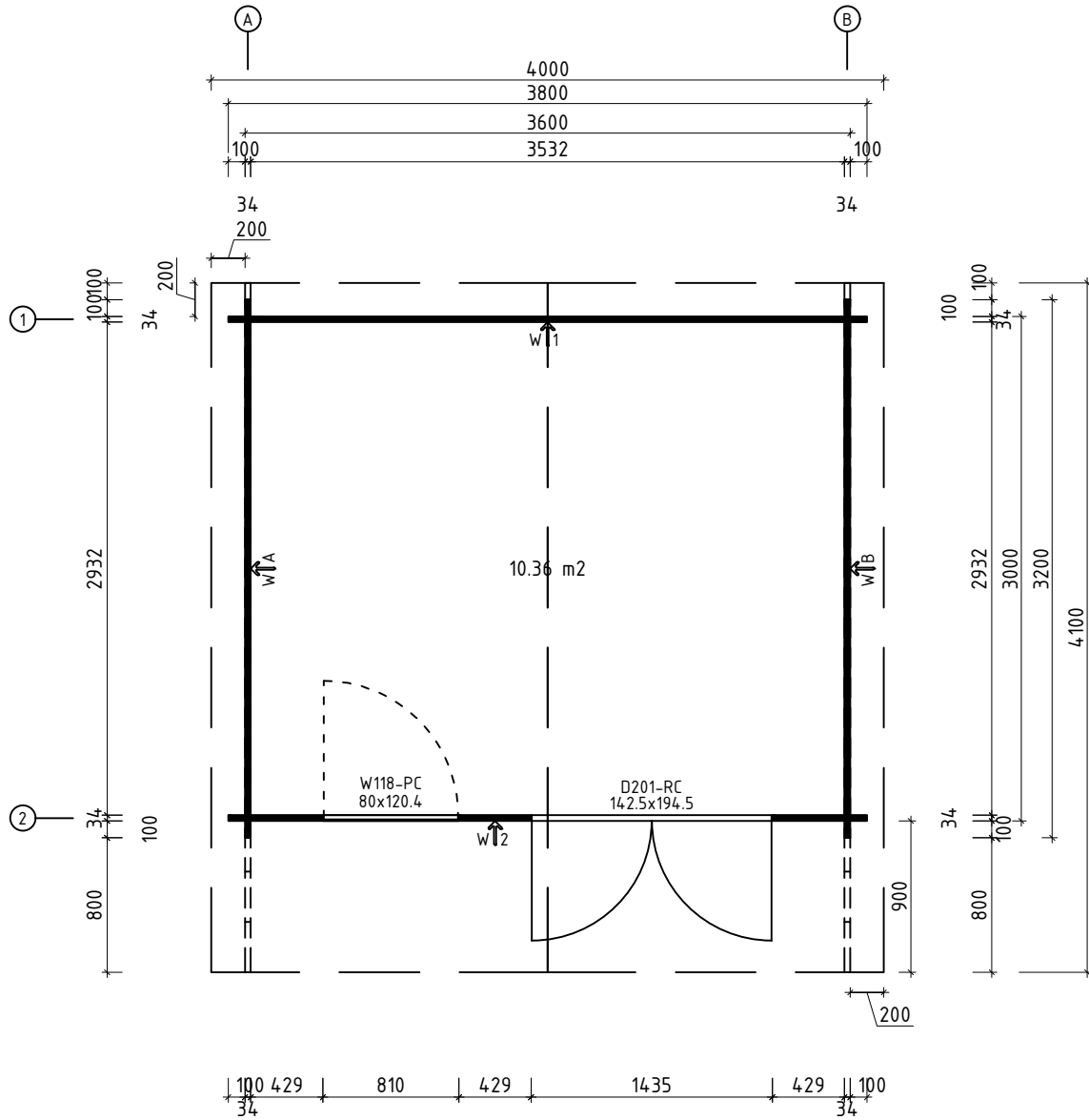



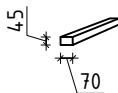
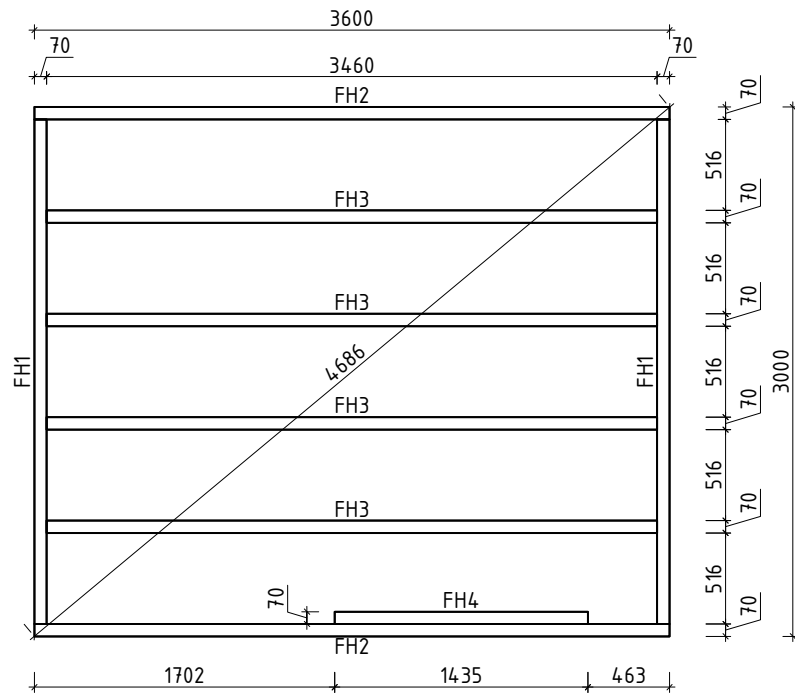











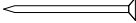

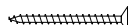
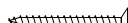

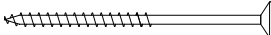
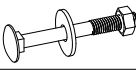

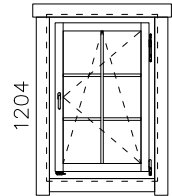
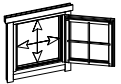



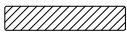



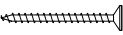



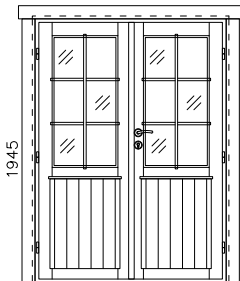



Wir empfehlen als Fundament für Ihr Gartenhaus eine vollflächig festgegründete, gepflasterte oder betonierte Fläche. Wahlweise ist auch ein Punkt- oder Streifenfundament möglich.

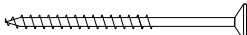

| Nr. | | Stck | Profil (mm) | Länge (mm) |
|------|-----------------------------------|------|-------------|------------|
| 001 | | 1 | 34x114 | 4100 |
| 002 | | 1 | 34x114 | 4100 |
| 004 | | 17 | 34x114 | 3800 |
| 005 | | 1 | 34x57 | 3800 |
| 006 | | 2 | 34x114 | 3700 |
| 007 | | 2 | 34x114 | 3400 |
| 008 | | 30 | 34x114 | 3200 |
| 011 | | 1 | 34x57 | 1802 |
| 012 | | 6 | 34x114 | 1802 |
| 015 | | 1 | 34x57 | 563 |
| 016 | | 28 | 34x114 | 563 |
| 017 | | 11 | 34x114 | 429 |
| W1-1 | | 1 | | |
| W2-1 | | 1 | | |
| FH2 | FUNDAMENTHÖLZER (imprägniert) | 2 | 70x45 | 3600 |
| FH3 | FUNDAMENTHÖLZER (imprägniert) | 4 | 70x45 | 3460 |
| FH1 | FUNDAMENTHÖLZER (imprägniert) | 2 | 70x45 | 2860 |
| FH4 | FUNDAMENTHÖLZER (imprägniert) | 1 | 70x45 | 1435 |
| PF1 | PFETTEN | 2 | 44x145 | 4100 |
| PF2 | PFETTEN | 1 | 44x145 | 4100 |
| | DACHBRETTER | 74+1 | 113x18 | 2105 |
| | FUSSBODENBRETTER | 32+1 | 113x18 | 2925 |
| | FUSSBODENLEISTEN | ✓ | 18x40 | 15.0lfm |

| Nr. | | | Stck | Profil (mm) | Länge (mm) |
|-------------|--|---|------|-------------|------------|
| G02-1 | GIEBELBRETTER 18x120 |  | 4 | 18x120 | 2185 |
| G06-1 | GIEBELDECKLEISTEN 18x58 |  | 4 | 18x58 | 2185 |
| T06-1 | TRAUFELEISTEN 18x40 |  | | 18x40 | 8.5lfm |
| T01-1 | TRAUFE NBRETTER 18x95 |  | 2 | 18x95 | 4100 |
| GS | Giebelsegment |  | 2 | | |
| SM-1 | Sturmleisten |  | 4 | 18x40 | 1940 |
| SH | Schlaghölzer |  | 3 | | |
| NG2 550 | NÄGEL 2.5x50 Dachbretter |  | 444 | | |
| NG2 550 | NÄGEL 2.5x50 Fussbodenbretter |  | 384 | | |
| SR3 030 | SCHRAUBEN 3.0x30 Fussbodenleisten |  | 26 | | |
| SR3 030 | SCHRAUBEN 3.0x30 Traufenleisten |  | 18 | | |
| SR3 545 | SCHRAUBEN 3.5x45 Giebelbretter |  | 20 | | |
| SR3 545 | SCHRAUBEN 3.5x45 Giebeldeckleisten |  | 20 | | |
| SR3 545 | SCHRAUBEN 3.5x45 Giebelsegment |  | 4 | | |
| SR3 545 | SCHRAUBEN 3.5x45 Traufenbretter |  | 18 | | |
| SR5 0100 | SCHRAUBEN 5.0x100 Fundamenthölzer |  | 36 | | |
| SS024 | Schloßschrauben M8x70 Mutter M8 U-Scheibe Ø25 - Befestigung für Sturmleisten |  | 12 | | |
| | | | | | |
| | | | | | |
| | | | | | |
| | | | | | |
| | | | | | |
| | | | | | |
| | | | | | |
| | | | | | |
| | ✓ - bitte selber anpassen (falls nötig)! | | | | |

| Nr. | | Stck | Profil (mm) | Länge (mm) |
|----------------|---|------|-------------|------------|
| | <p align="center">FENSTER 800x1204 W4-S34P-06C-08001204</p> <div style="display: flex; justify-content: space-between; align-items: flex-start;"> <div style="text-align: center;"> <p>Q4 W118-PC 800</p>  </div> <div style="border: 1px solid gray; padding: 5px; width: 180px;"> <p>Right handed / DIN rechts / paremakäeline</p> </div> <div style="border: 1px solid gray; padding: 5px; width: 180px;"> <p>Clear opening/ durchgangsmaß/ ava suurus</p> <p>644x1031mm</p>  </div> <div style="border: 1px solid gray; padding: 5px; width: 180px;"> <p>double-pane clear float glass</p> <p>ISO Glas 2-fach</p> <p>2x klaaspakett, kirgas klaas</p> <p>585x979mm</p>  </div> </div> | 1 | | |
| VP54 32-1 | Q4 Window sill - Fensterbank - Veeplekk  | 1 | | 642 |
| PROSS H41-1 | Q4-1 Muntins - Sprossen - Prossid horizontal 18x18  | 2 | 18x18 | 610 |
| PROSS V42-1 | Q4-2 Muntins - Sprossen - Prossid vertical 18x18  | 1 | 18x18 | 1014 |
| PL3-1 | Trims - Rahmenleisten - Piirdeliistud 18x95  ✓ | 2 | 18x95 | 1000 |
| PL3-2 | Trims - Rahmenleisten - Piirdeliistud 18x95  ✓ | 4 | 18x95 | 1285 |
| PL3-3 | Trims - Rahmenleisten - Piirdeliistud 18x95  ✓ | 2 | 18x95 | 760 |
| SR30 22-01 | 3.0x20ÜP Muntins - Sprossen - Prossid  | 6 | | |
| SR35 45-01 | 3.5x45 Trims - Rahmleisten - Piirdeliistud  | 24 | | |
| AL-Q4 | Q4 Window handle - Fenstergriff - Aknalink  | 1 | | |
| | | | | |
| | | | | |
| | | | | |
| | | | | |
| | | | | |
| | | | | |
| | | | | |
| | | | | |
| | | | | |
| | | | | |
| | | | | |

| Nr. | | Stck | Profil (mm) | Länge (mm) |
|--------------------|---|------|-------------|------------|
| | <p style="text-align: center;">TÜR 1425x1945 D4-D34R-56C-14251945</p> <p>Q4 D201-RC 1425</p>  <div style="display: flex; justify-content: space-between;"> <div data-bbox="786 398 1082 454"> <p>Right handed / DIN rechts / paremakäeline</p> </div> <div data-bbox="786 461 1082 573"> <p>Clear opening/ durchgangsmaß/ ava suurus 1297x1837mm</p>  </div> </div> <div style="display: flex; justify-content: space-between;"> <div data-bbox="786 580 1082 728"> <p>double-pane clear float glass ISO Glas 2-fach 2x klaaspakett, kirgas klaas</p> </div> <div data-bbox="970 584 1066 674">  <p>472x950mm</p> </div> </div> | 1 | | |
| PROSS H41-2 | Q4-1 Muntins - Sprossen - Prossid horizontal 18x18  | 4 | 18x18 | 497 |
| PRO SS V42-2 | Q4-2 Muntins - Sprossen - Prossid vertical 18x18  | 2 | 18x18 | 975 |
| PL3-4 | Trims - Rahmenleisten - Piirdeliistud 18x95  ✓ | 4 | 18x95 | 1925 |
| PL3-5 | Trims - Rahmenleisten - Piirdeliistud 18x95  ✓ | 2 | 18x95 | 1625 |
| SR30 20-01 | 3.0x20 Locking plate - Schließblech - Riivi vastus 02 Q4-Q5  | 2 | | |
| SR30 22-01 | 3.0x20ÜP Muntins - Sprossen - Prossid  | 12 | | |
| SR35 45-01 | 3.5x45 Trims - Rahmleisten - Piirdeliistud  | 24 | | |
| SR50 90-01 | 5.0x90 Door frames - Türrahmen - Ukselengid  | 8 | | |
| RV02 | Locking plate - Schließblech - Riivi vastus 02 Q4-Q5  | 1 | | |
| LS-Q4 | Q4 Cylinder lock - Zylinderschloss - Lukusüdamik  | 1 | | |
| UL-Q4 | Q4 Door handle - Türgriff - Ukselink  | 1 | | |
| | | | | |
| | | | | |
| | | | | |
| | | | | |
| | | | | |
| | | | | |
| | | | | |
| | | | | |
| | | | | |

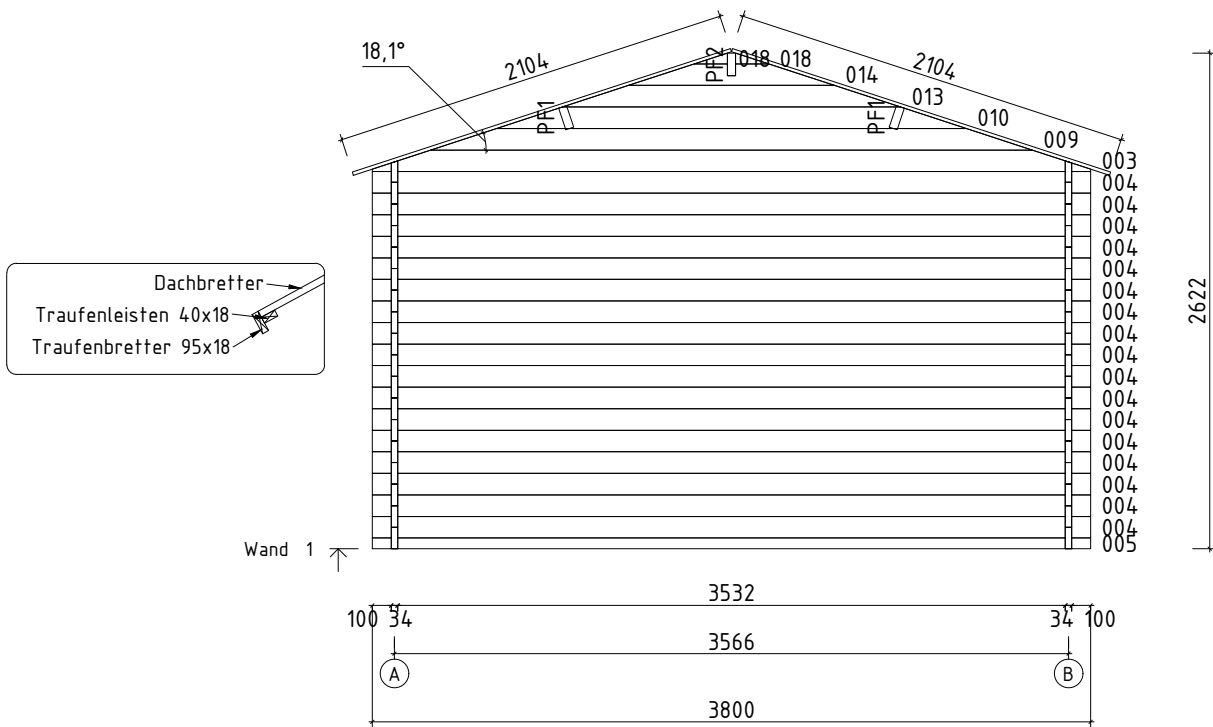

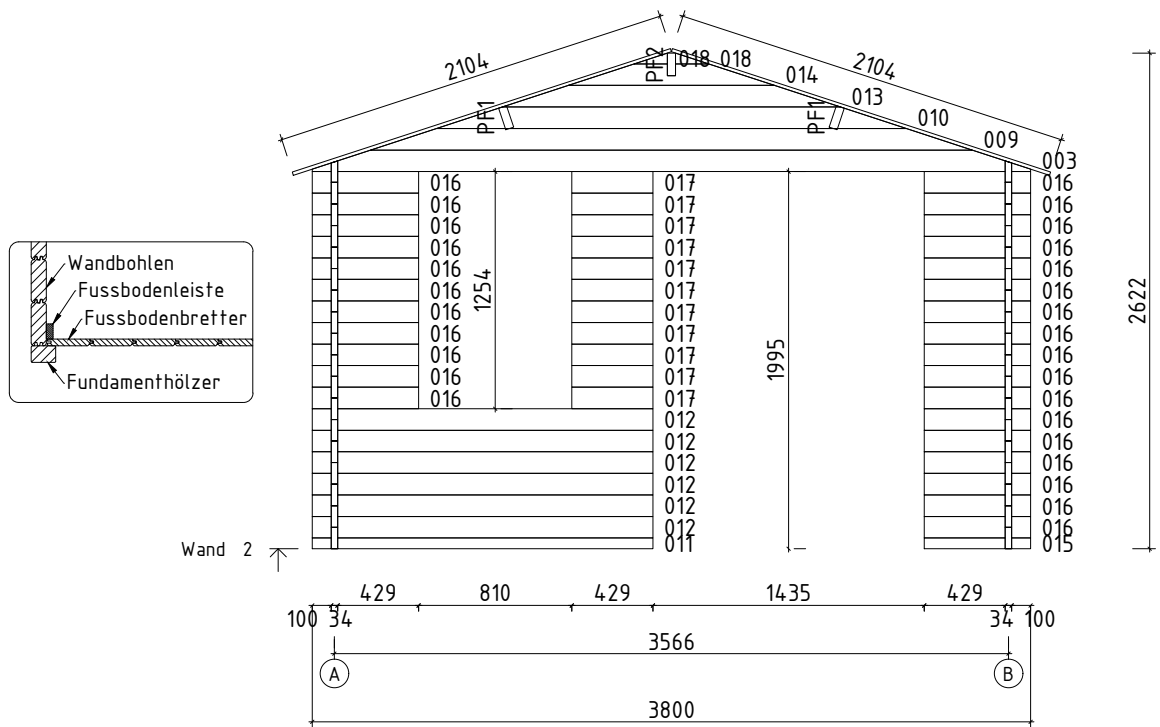

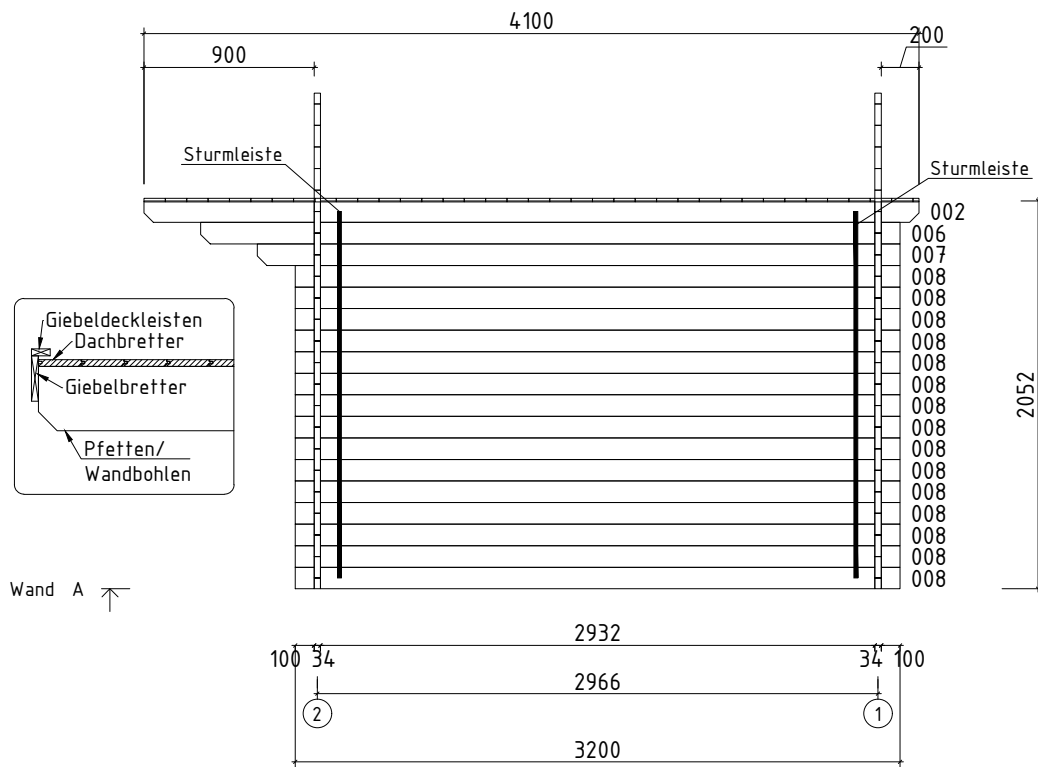

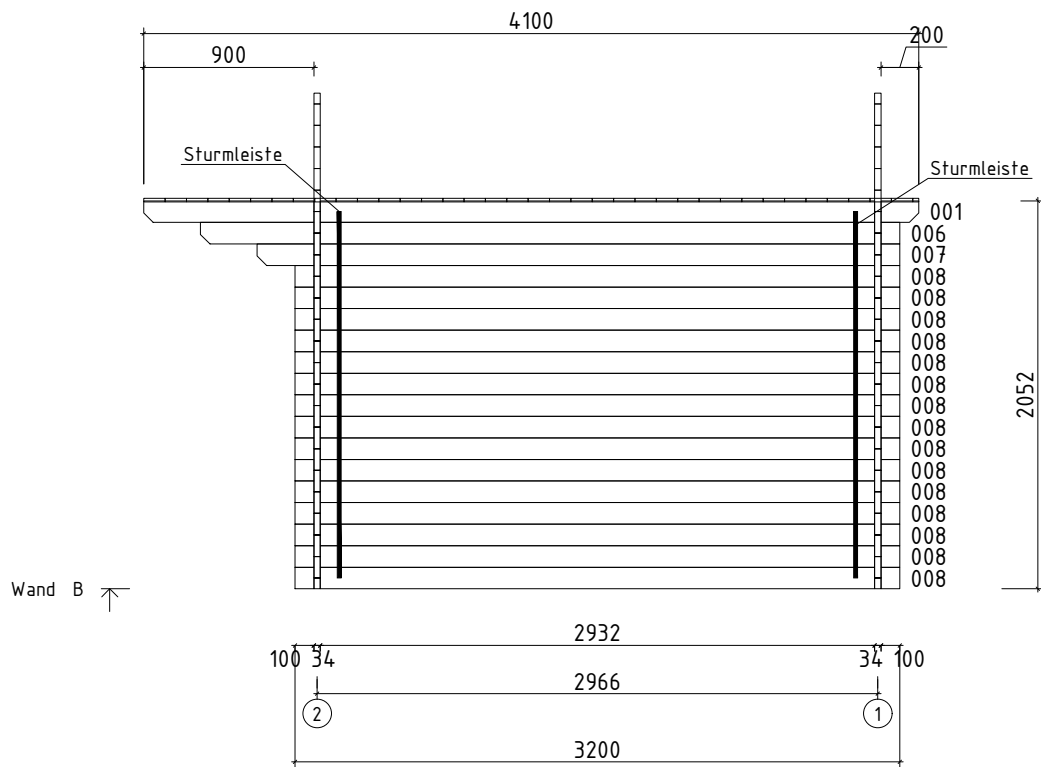

Aken Q4-Q6 - paigaldusjuhised
 Window Q4-Q6 - assembly instructions
 Fenster Q4-Q6 - Montageanleitung

