

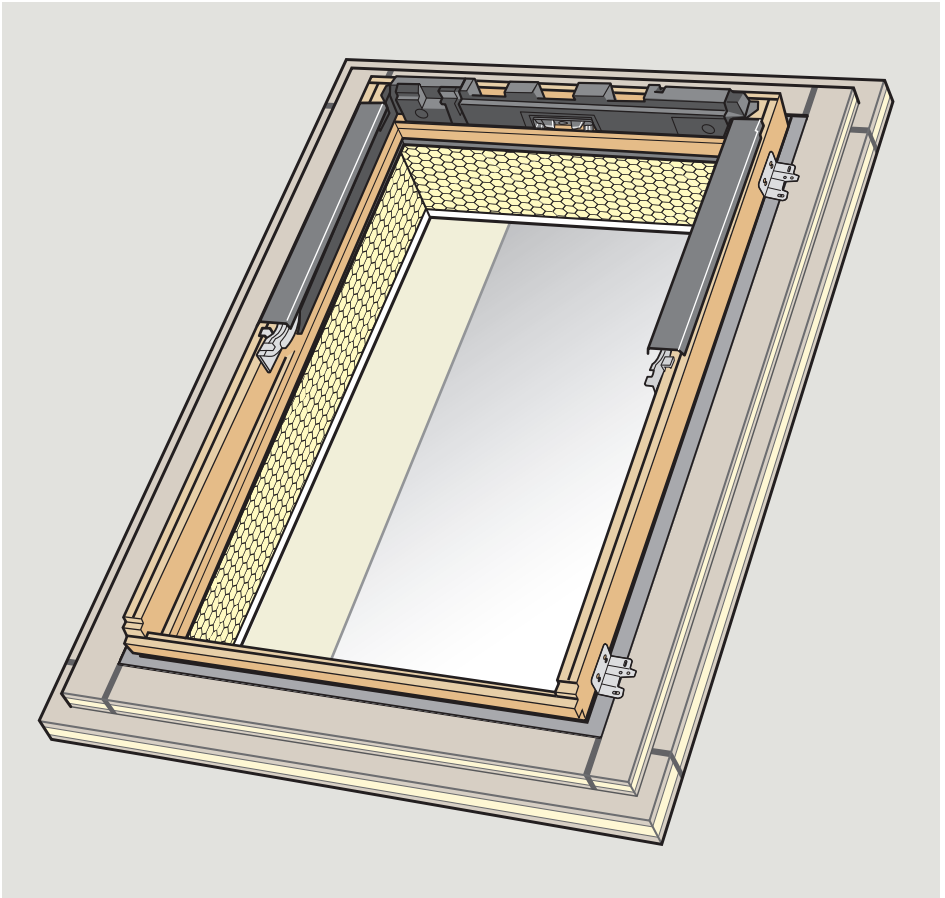

BGX ■

**Hinweis: Produkt passend für Dachaufbau
40 mm /30 mm (Konterlattung/Dachlattung)**

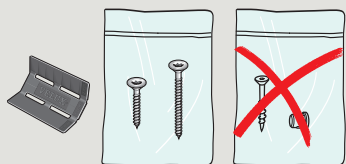

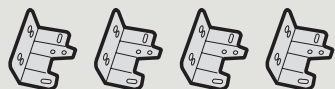
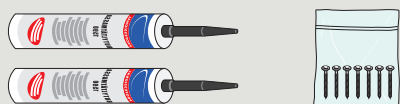
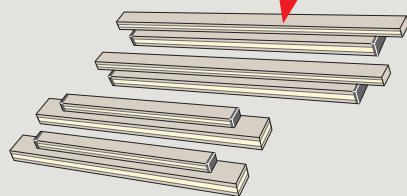
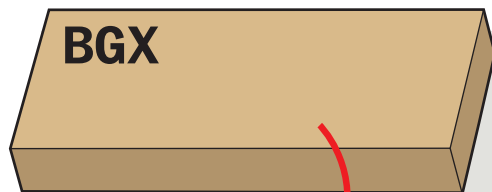

 16	
EN 13165:2012+A2:2016 Notified body: 0751	
BGX	
Thermal insulation for buildings	
Thermal resistance: - Thermal resistance R_D - Thermal conductivity λ_D - Thickness d_N	NPD 0.027 W/(m·K) NPD
Reaction to fire:	Class E
Durability of thermal resistance against heat, weathering, ageing/degradation:	NPD
Compressive strength:	NPD
Tensile strength:	NPD
Durability of compressive strength against ageing/degradation:	NPD
Water permeability:	NPD
Water vapour permeability:	NPD
Acoustic absorption index:	NPD
Release of dangerous substances to the indoor environment:	NPD
Continuous glowing combustion:	NPD
VELUX A/S Ådalsvej 99 DK-2970 Hørsholm www.velux.com/ce	

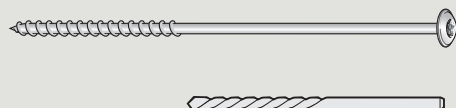
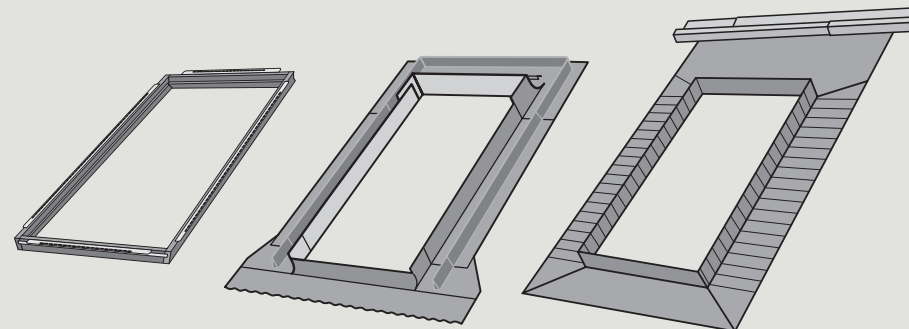
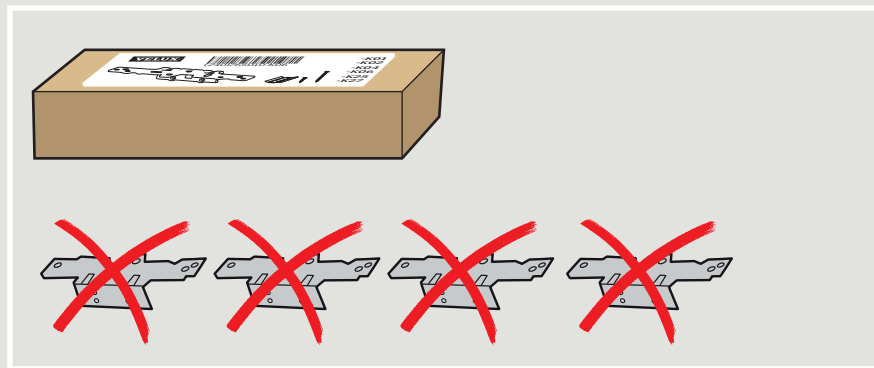
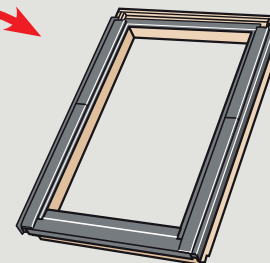

Systemschrauben des Dämmstoffherstellers verwenden (Ø 6-8 mm).

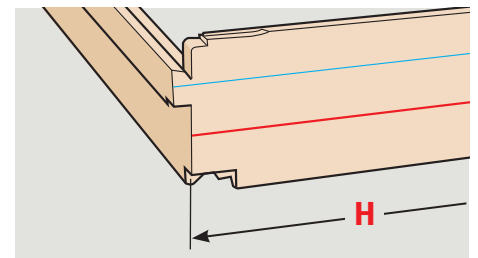
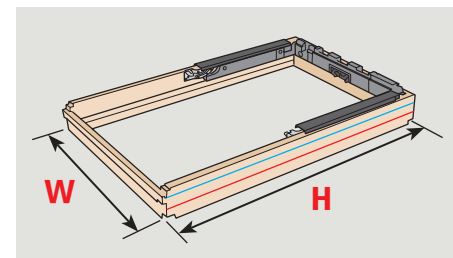
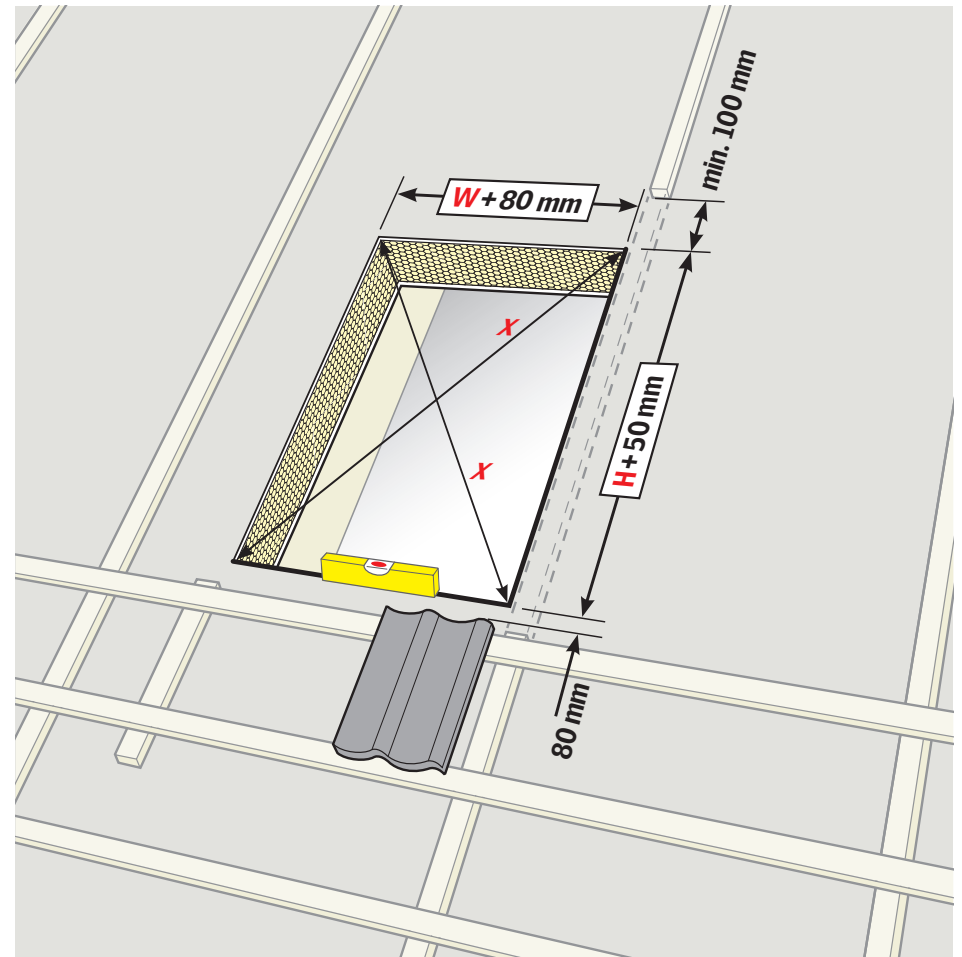
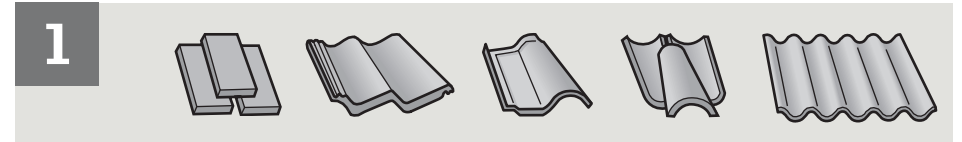
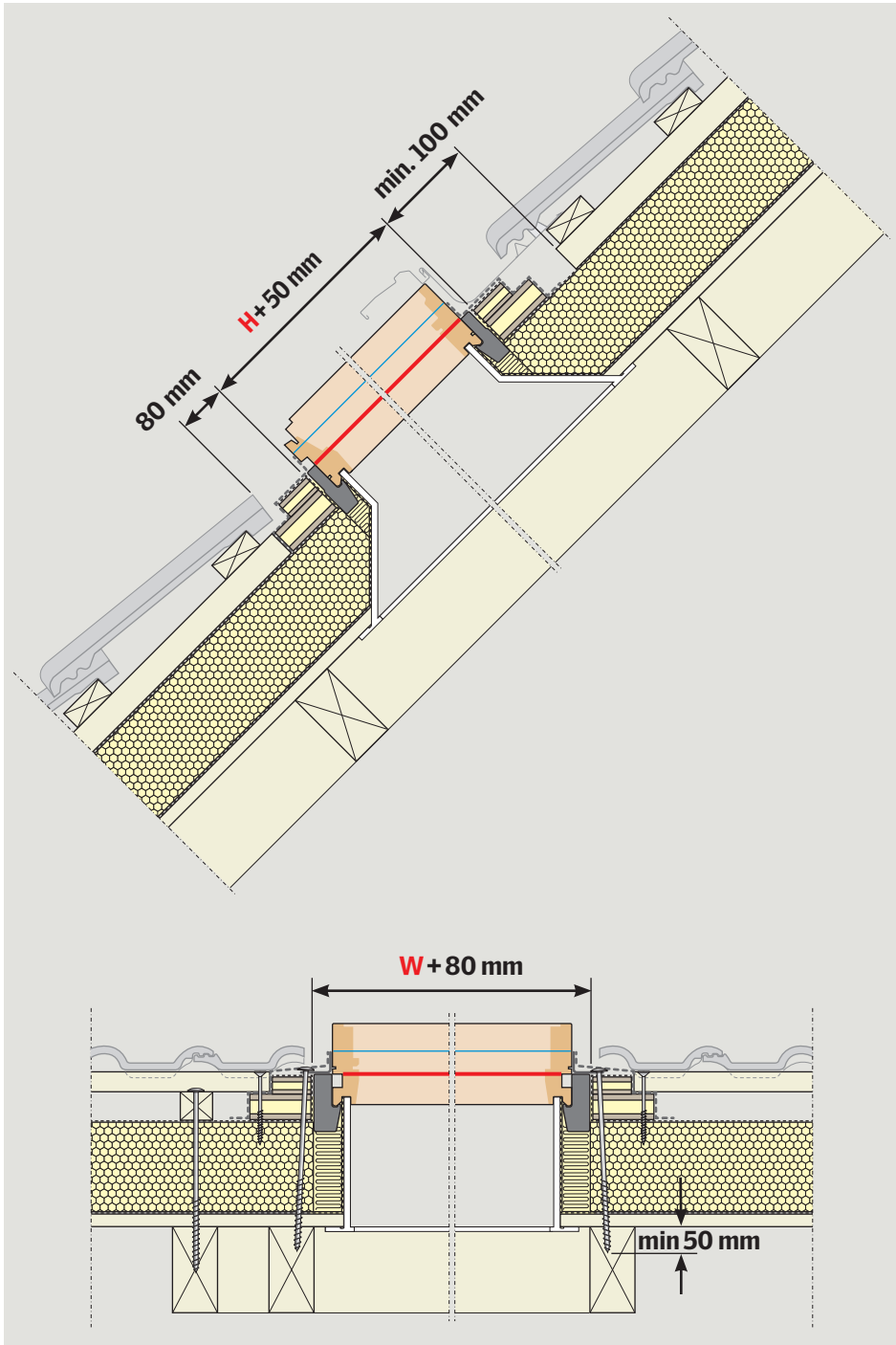

2

BGX

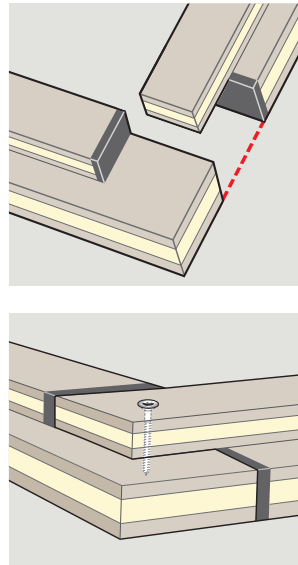
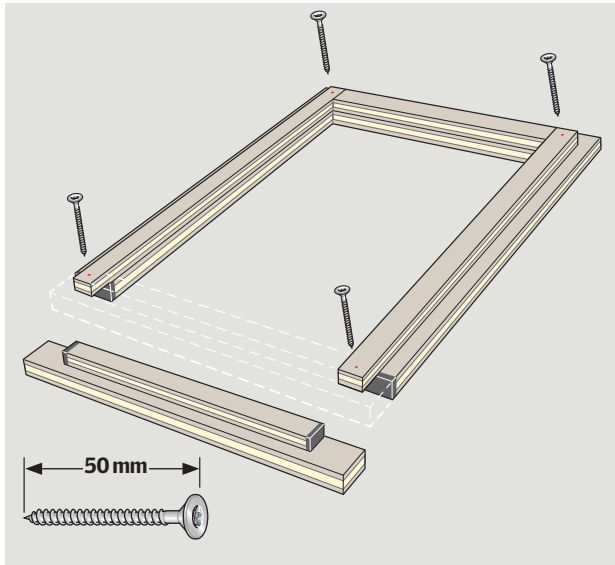
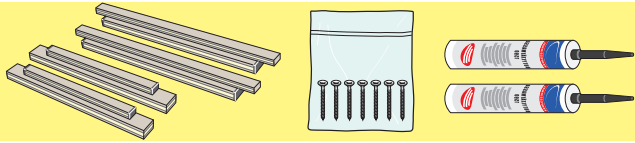

4

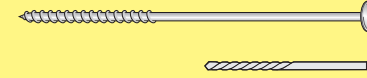

Systemschrauben des Dämmstoffherstellers verwenden (\varnothing 6-8 mm).

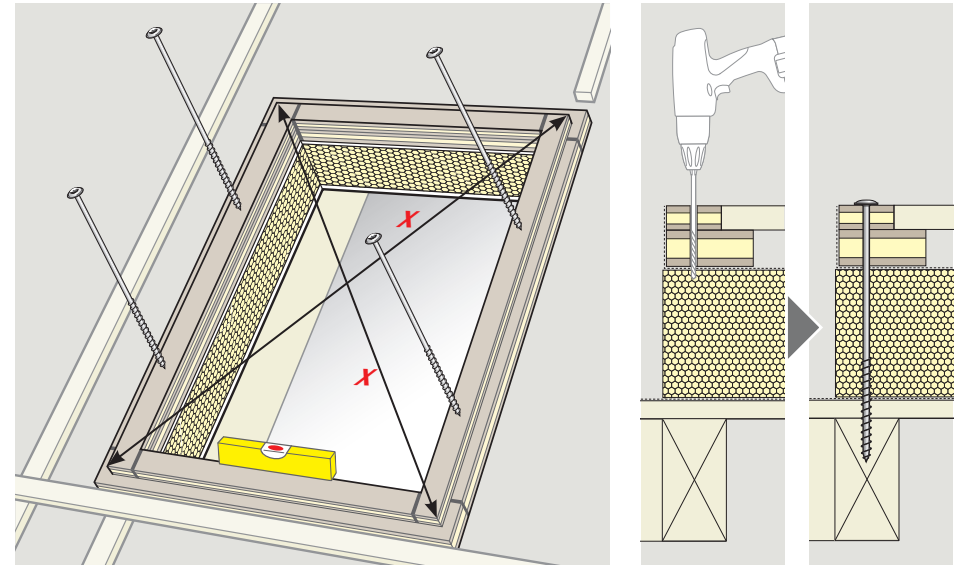

3

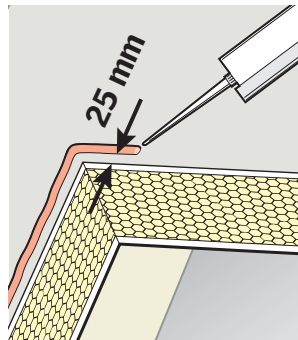
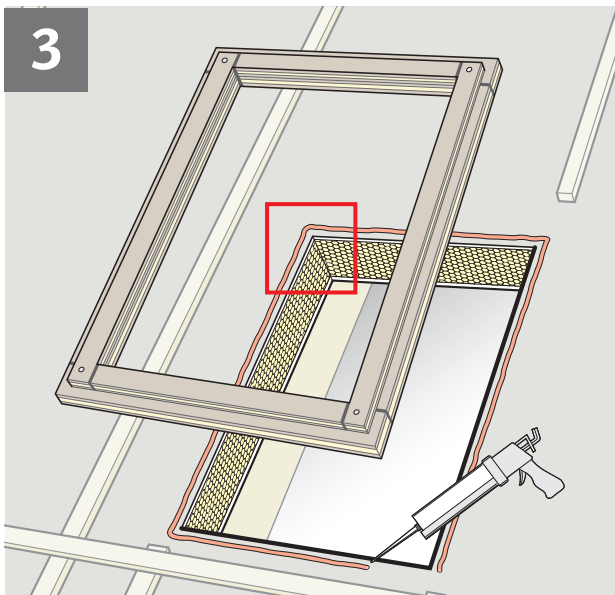

5

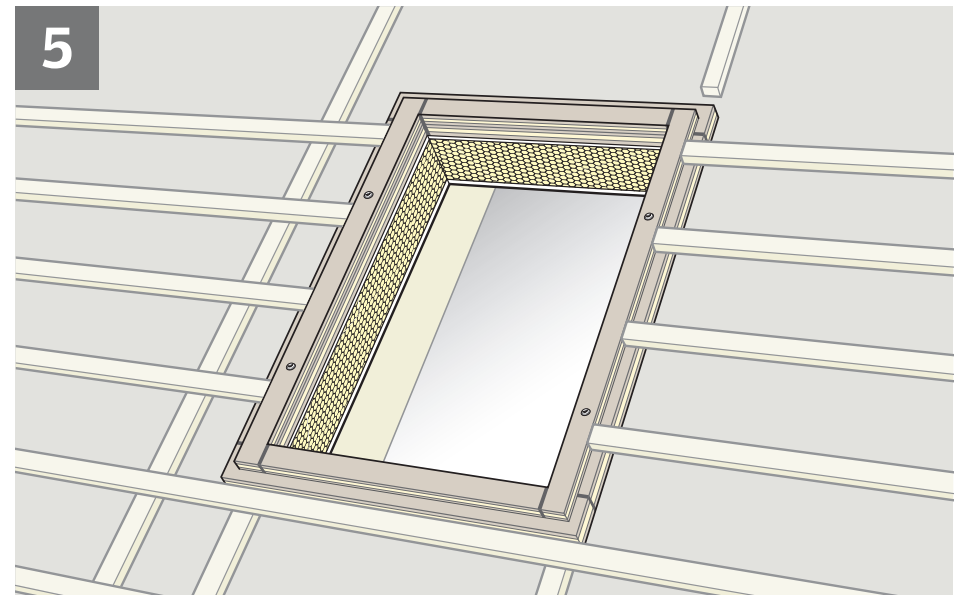

6

ED-

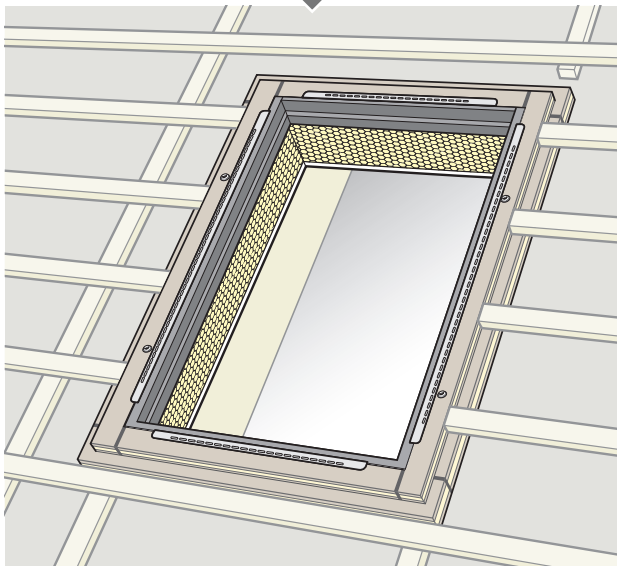
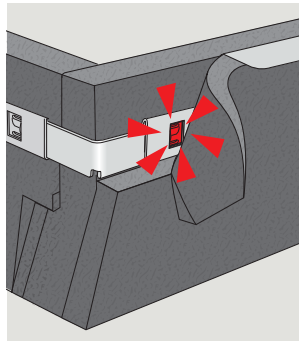
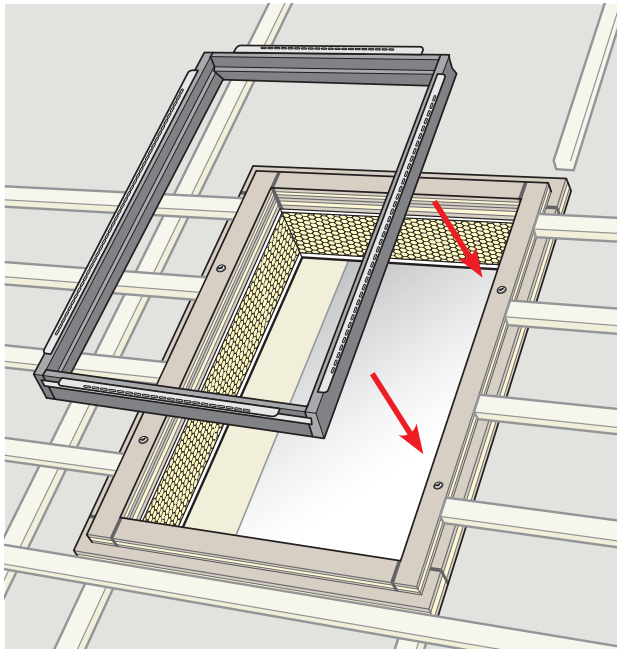
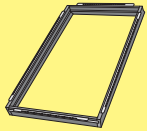

7

G--

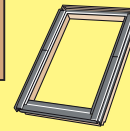

BGX

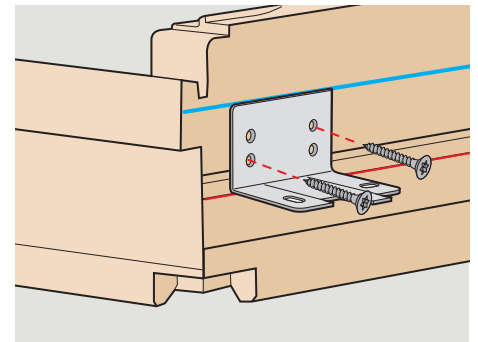
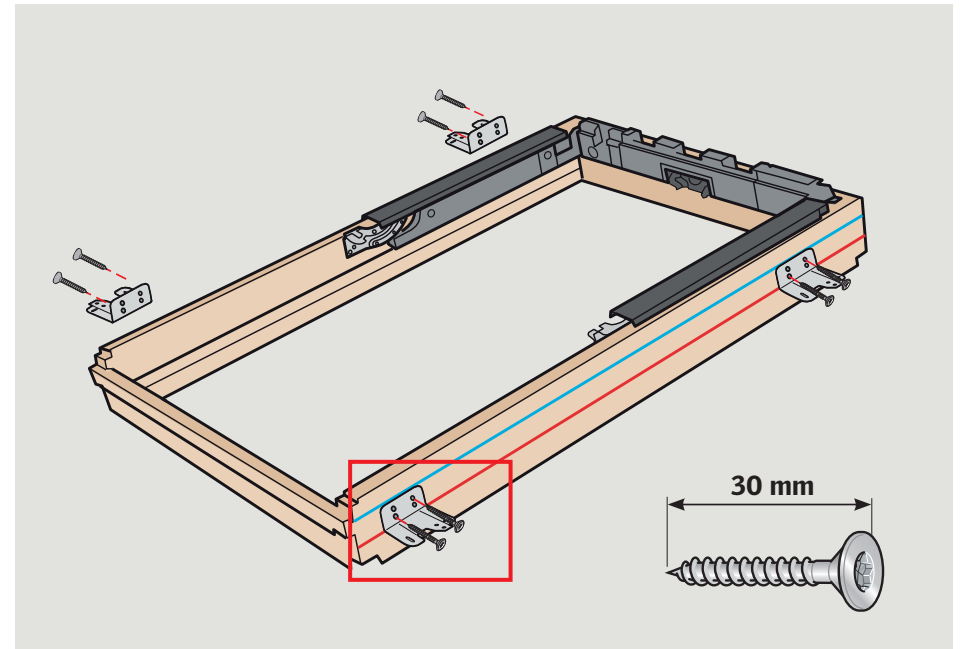
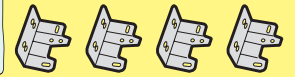
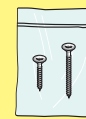

8

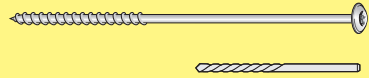

Systemschrauben des Dämmstoffherstellers verwenden (\varnothing 6-8 mm).

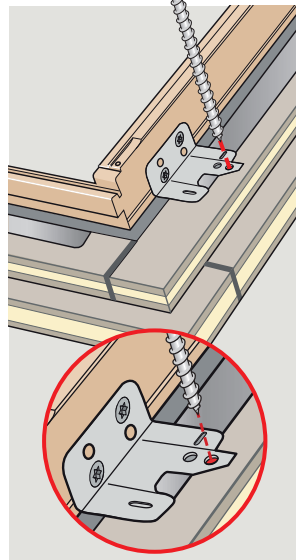
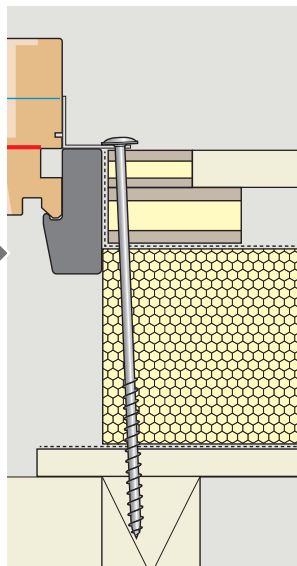
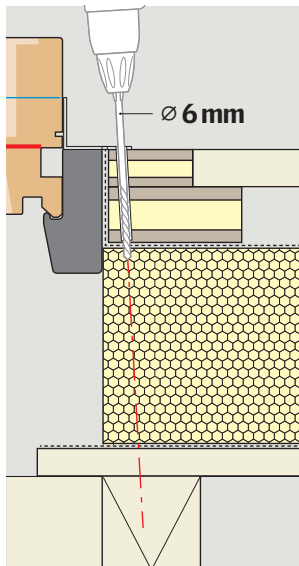
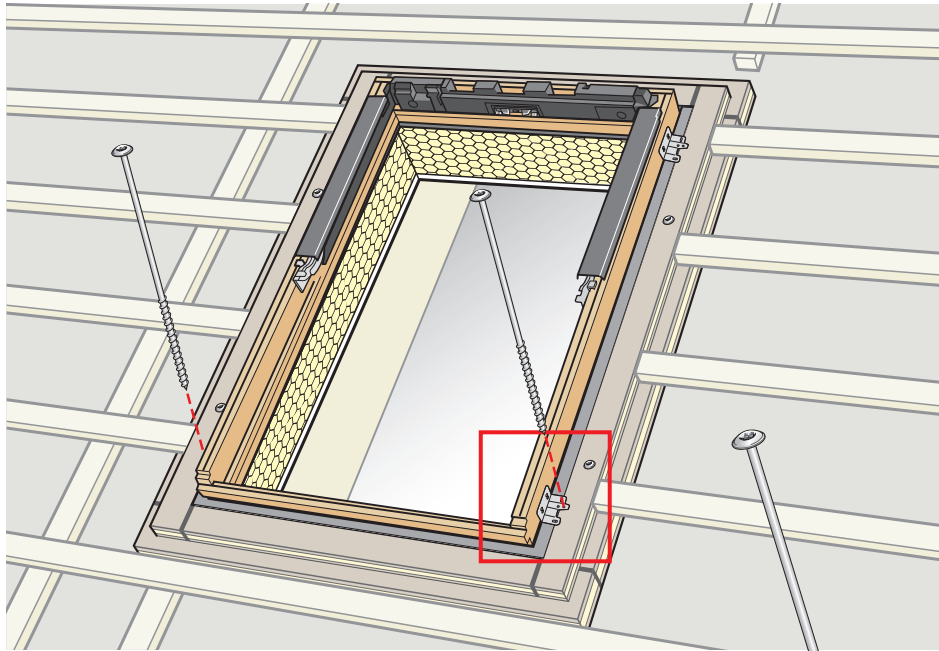

9

BGX

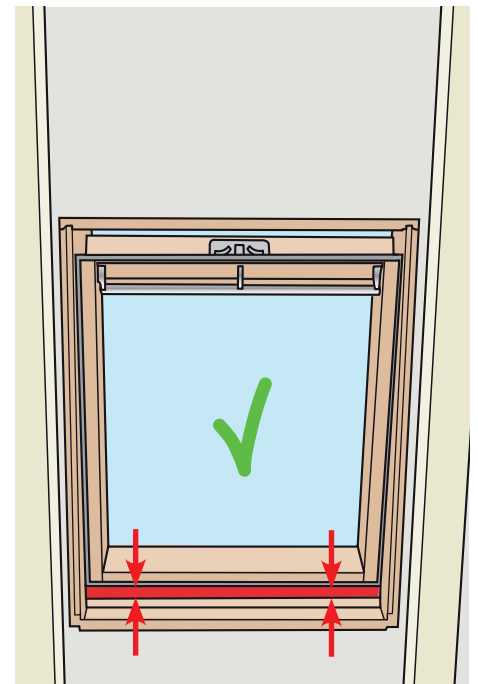
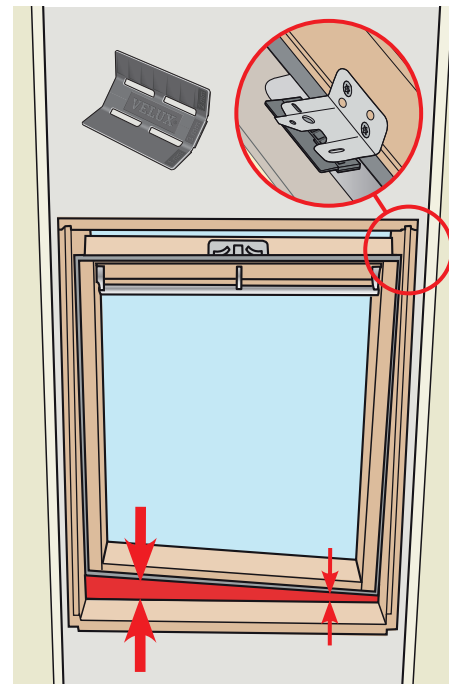
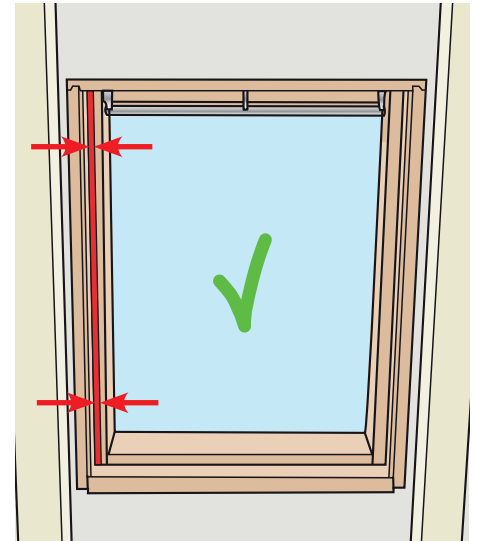
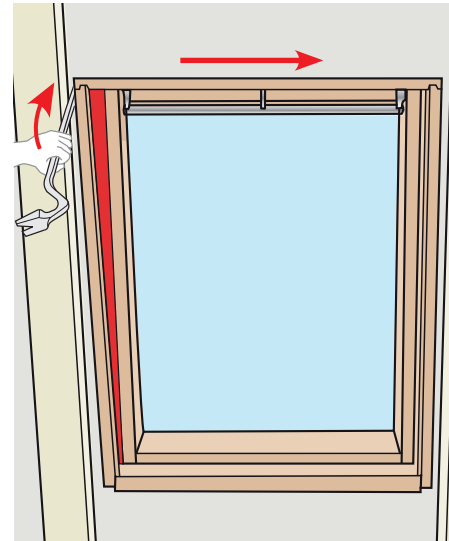
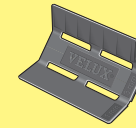

10

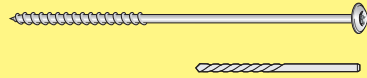

Systemschrauben des Dämmstoffherstellers verwenden (\varnothing 6-8 mm).

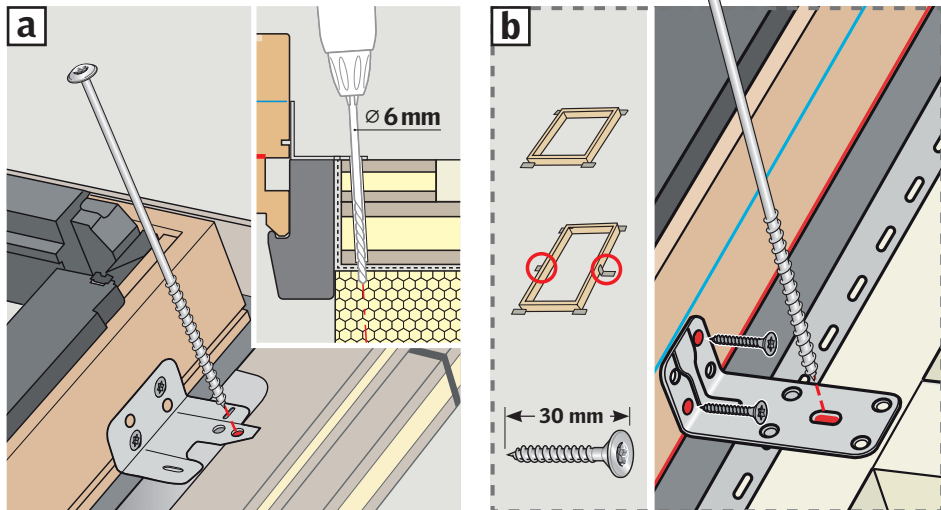
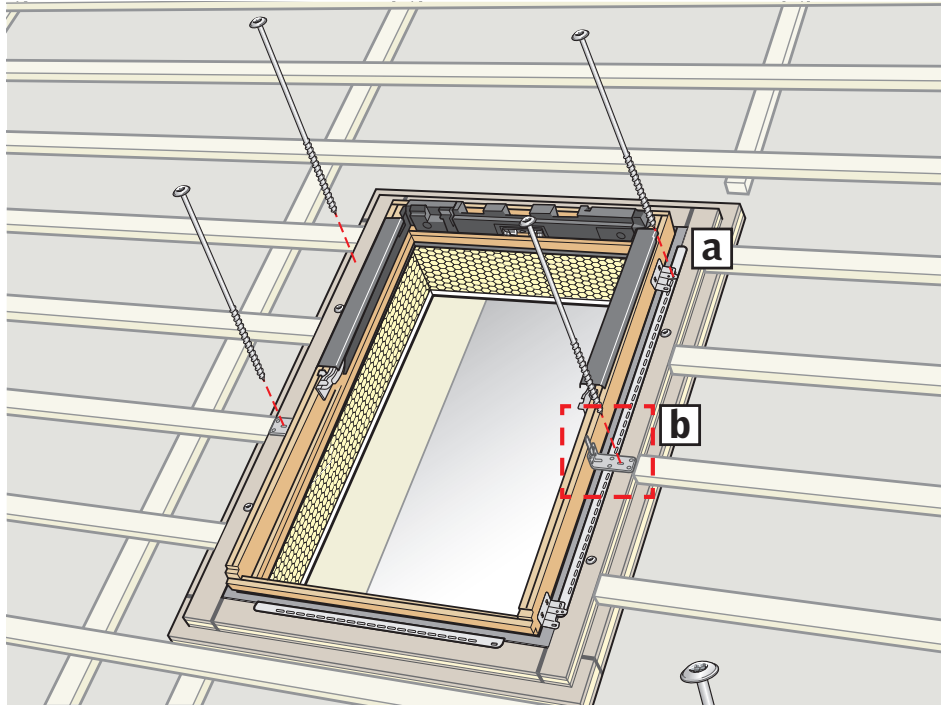

11

ED-

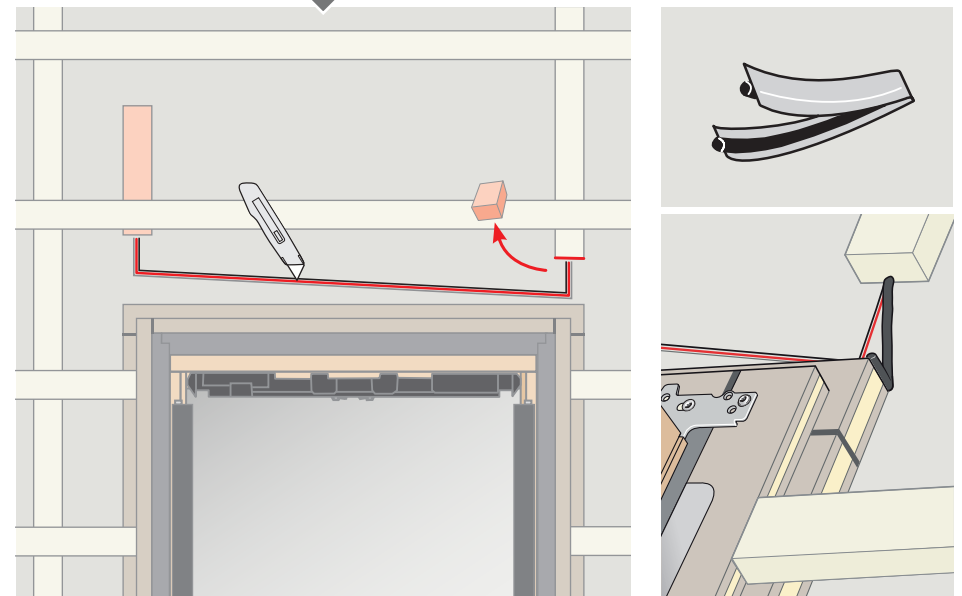
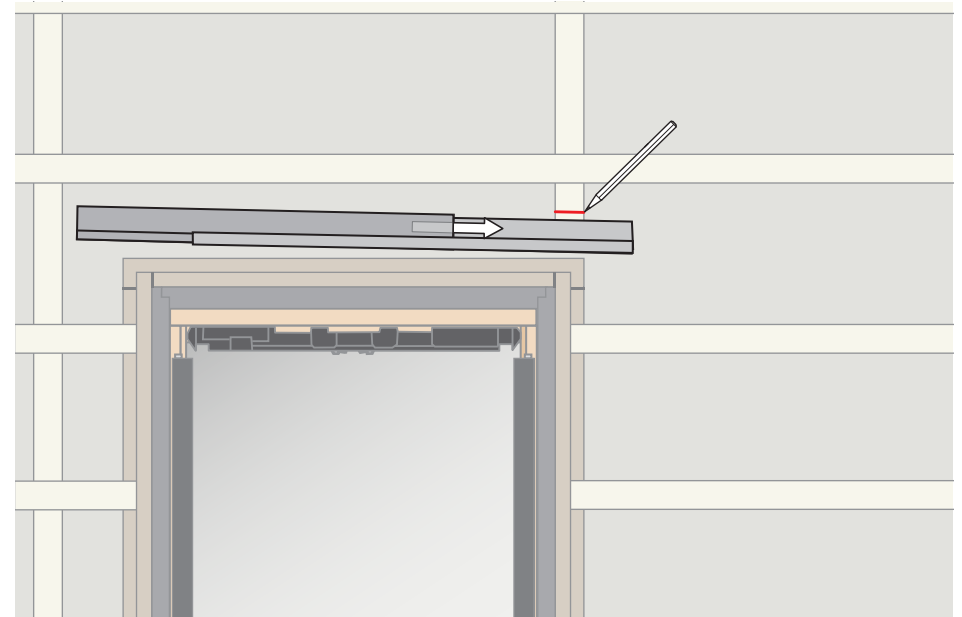
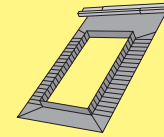

12 **BGX**

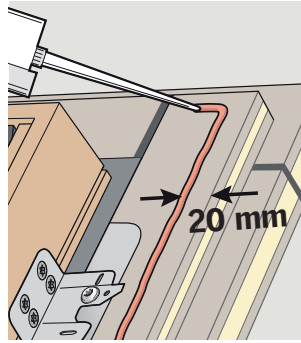
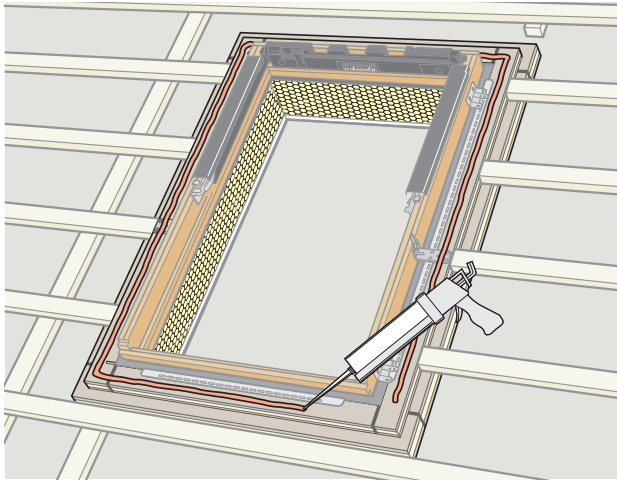
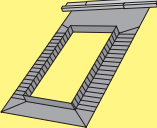
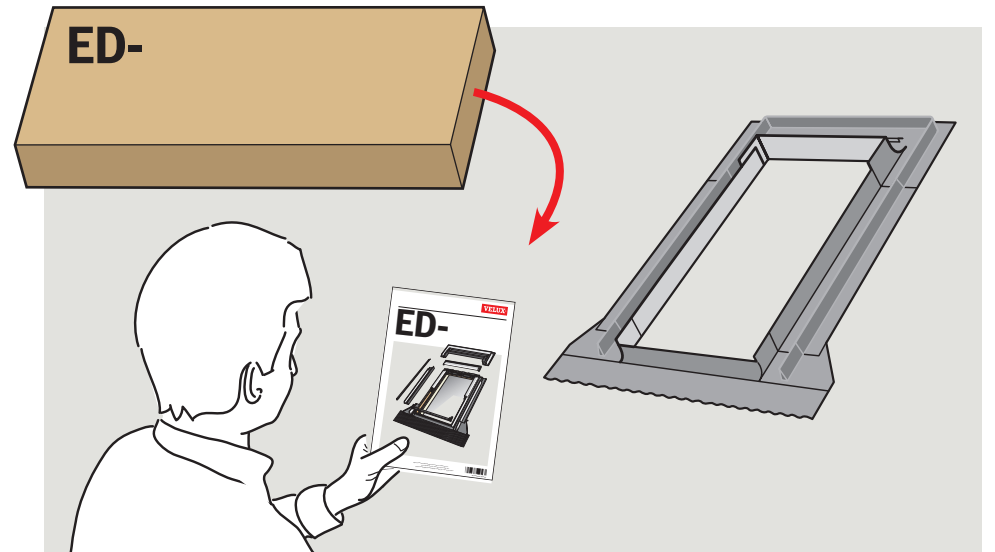
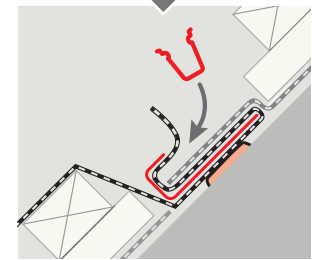
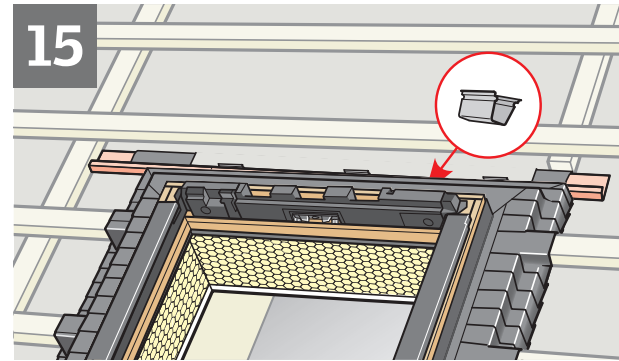
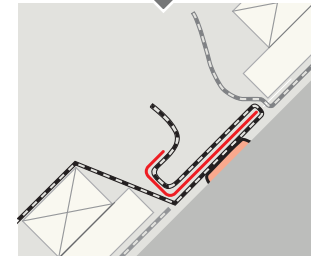
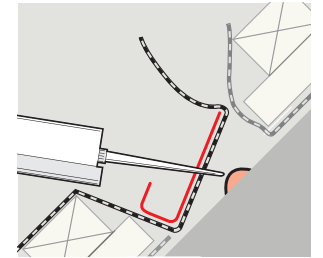
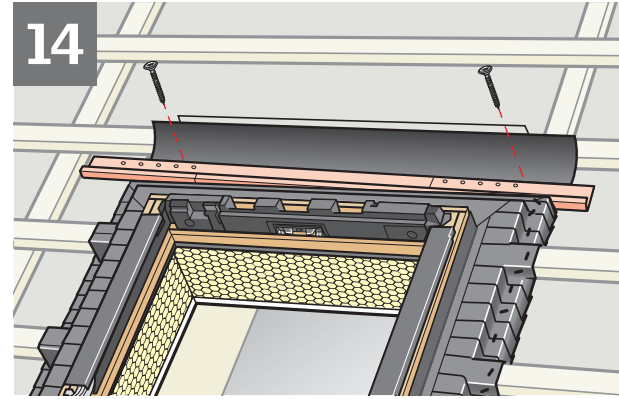
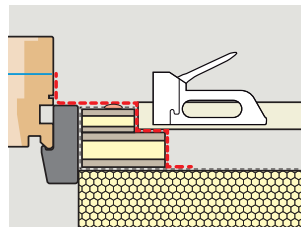
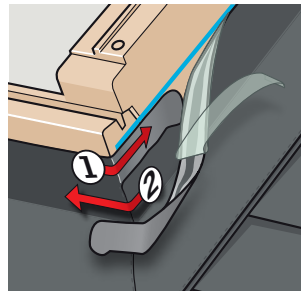
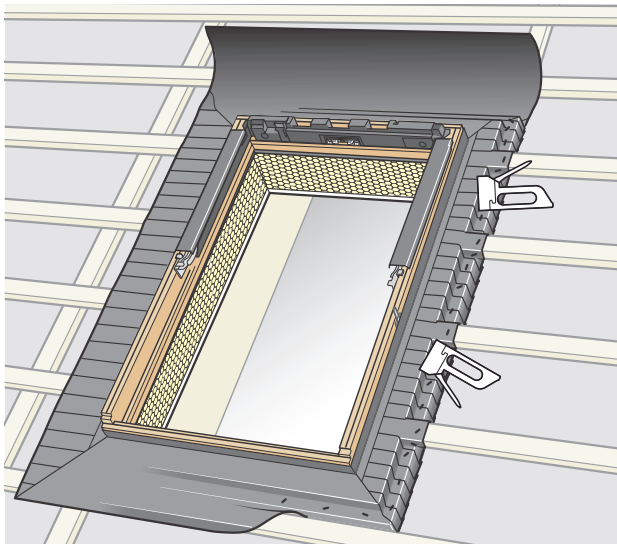
13 **ED-**

AR: VELUX Argentina S.A. 348 4 639944	HU: VELUX Magyarország Kft. (06/1) 436-0601
AT: VELUX Österreich GmbH 02245/32 3 50	IE: VELUX Company Ltd. 01 848 8775
AU: VELUX Australia Pty. Ltd. 1300 859 856	IT: VELUX Italia s.p.a. 045/6173666
BA: VELUX Bosna i Hercegovina d.o.o. 033/626 493, 626 494	JP: VELUX-Japan Ltd. 0570-00-8145
BE: VELUX Belgium (010) 42.09.09	LT: VELUX Lietuva, UAB (85) 270 91 01
BG: ВЕЛУКС България ЕООД 02/955 99 30	LV: VELUX Latvia SIA 67 27 77 33
BY: Унитарное предприятие "ВЕЛЮКС Мансардные Окна" (017) 329 20 89	NL: VELUX Nederland B.V. 030 - 6 629 629
CA: VELUX Canada Inc. 1 800 88-VELUX (888-3589)	NO: VELUX Norge AS 22 51 06 00
CH: VELUX Schweiz AG 062 289 44 45	NZ: VELUX New Zealand Ltd. 0800 650 445
CL: VELUX Chile Limitada 2 953 6789	PL: VELUX Polska Sp. z o.o. (022) 33 77 000 / 33 77 070
CN: VELUX (CHINA) CO. LTD. 0316-607 27 27	PT: VELUX Portugal, Lda 21 880 00 60
CZ: VELUX Česká republika, s.r.o. 531 015 511	RO: VELUX România S.R.L. 0-8008-83589
DE: VELUX Deutschland GmbH 01806 / 33 33 99 Festnetz: 0,20 €/Anruf Mobilfunk: max. 0,60 €/Anruf	RS: VELUX Srbija d.o.o. 011 20 57 500
DK: VELUX Danmark A/S 45 16 45 16	RU: ЗАО ВЕЛЮКС (495) 640 87 20
EE: VELUX Eesti OÜ 621 7790	SE: VELUX Svenska AB 042/20 83 80
ES: VELUX Spain, S.A. 91 509 71 00	SI: VELUX Slovenija d.o.o. 01 724 68 68
FI: VELUX Suomi Oy 0207 290 800	SK: VELUX Slovensko, s.r.o. (02) 33 000 555
FR: VELUX France 0821 02 15 15 0,119€ TTC/min	TR: VELUX Çatı PencereLeri Ticaret Limited Şirketi 0 216 302 54 10
GB: VELUX Company Ltd. 01592 778 225	UA: ТОВ "ВЕЛЮКС Україна" (044) 2916070
HR: VELUX Hrvatska d.o.o. 01/5555 444	US: VELUX America LLC 1-800-88-VELUX