

Technische Daten Mona 34-B

Wandaußenmaß: 300 x 300 cm

Bohlenstärke: 34 mm



Kontrolliert durch:

Achtung: Alle angegebenen Maße sind ca.-Maße!

3D-Ansicht und Grundriss Mona 34-B

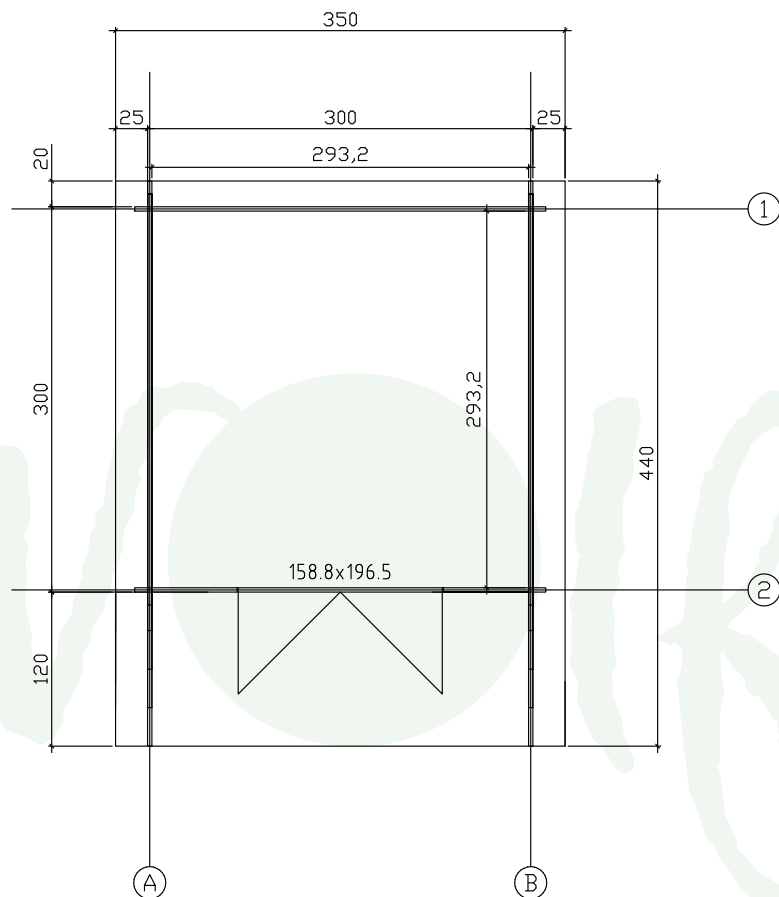
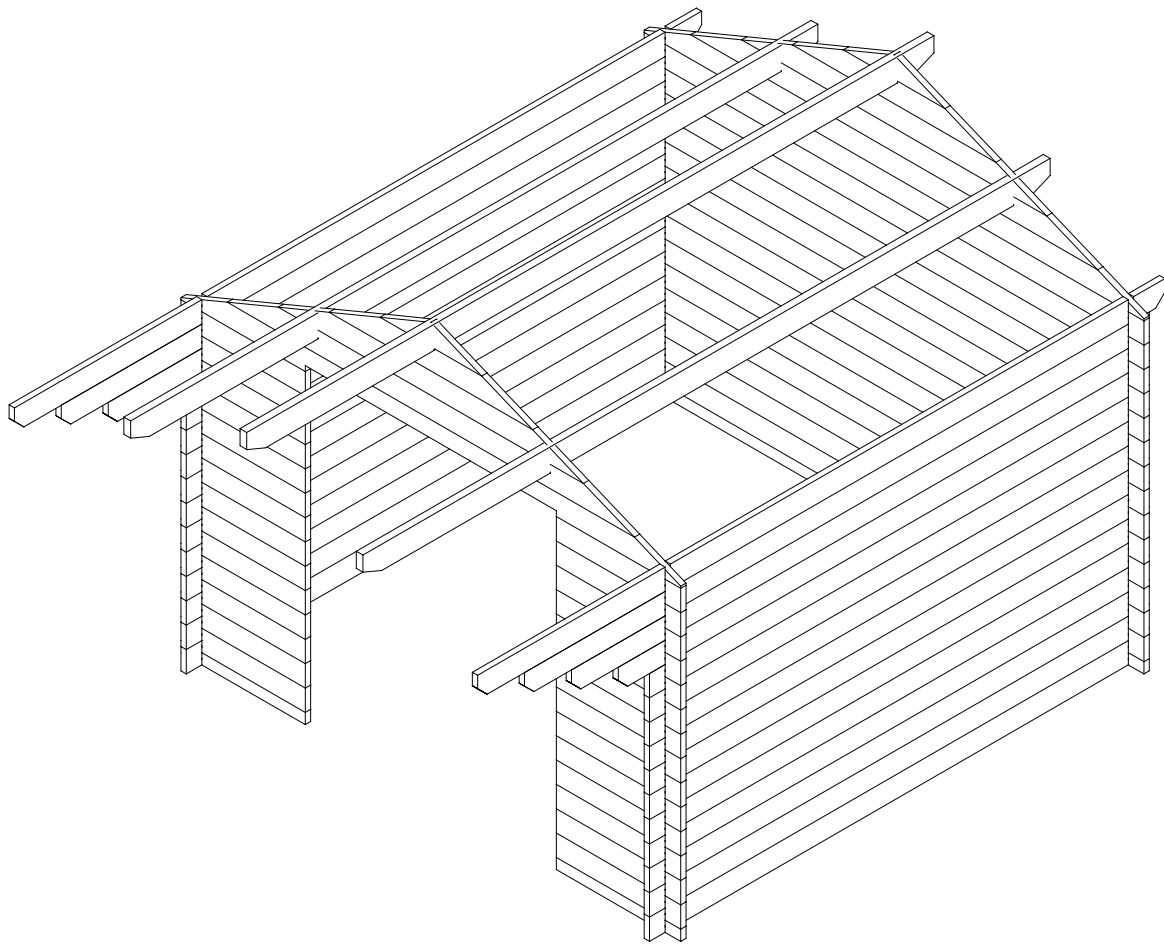

Lagerholzplan Mona 34-B

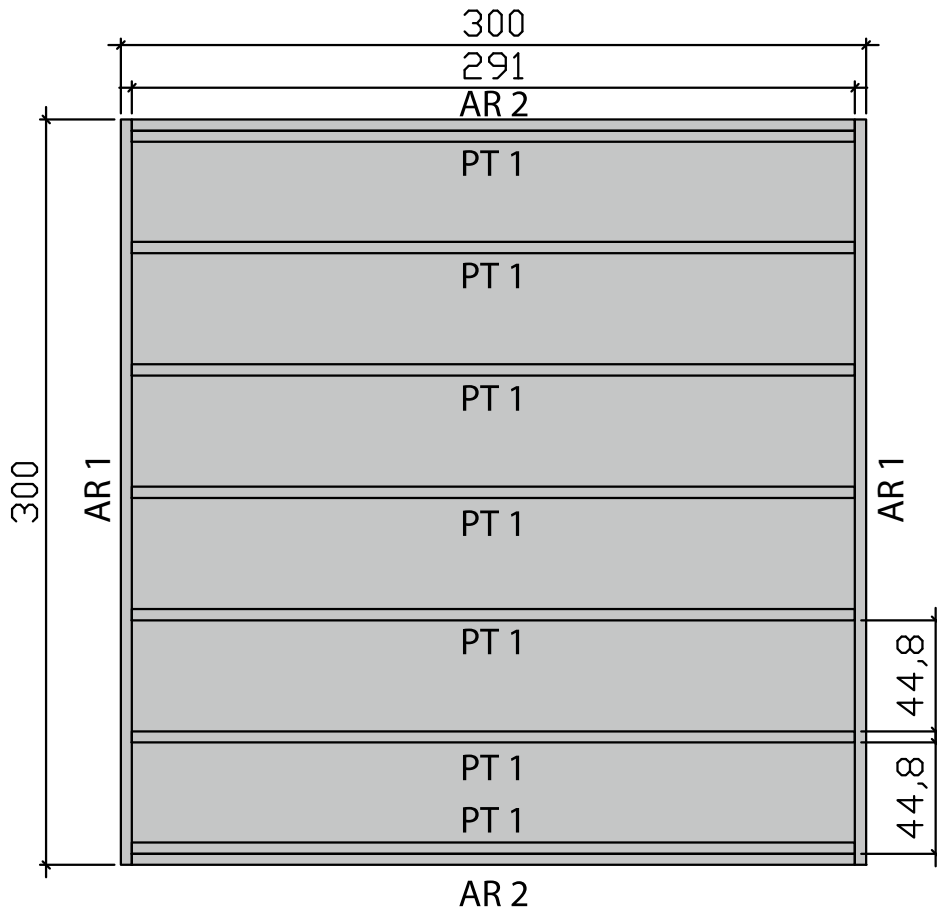

Fundamentplan Mona 34-B



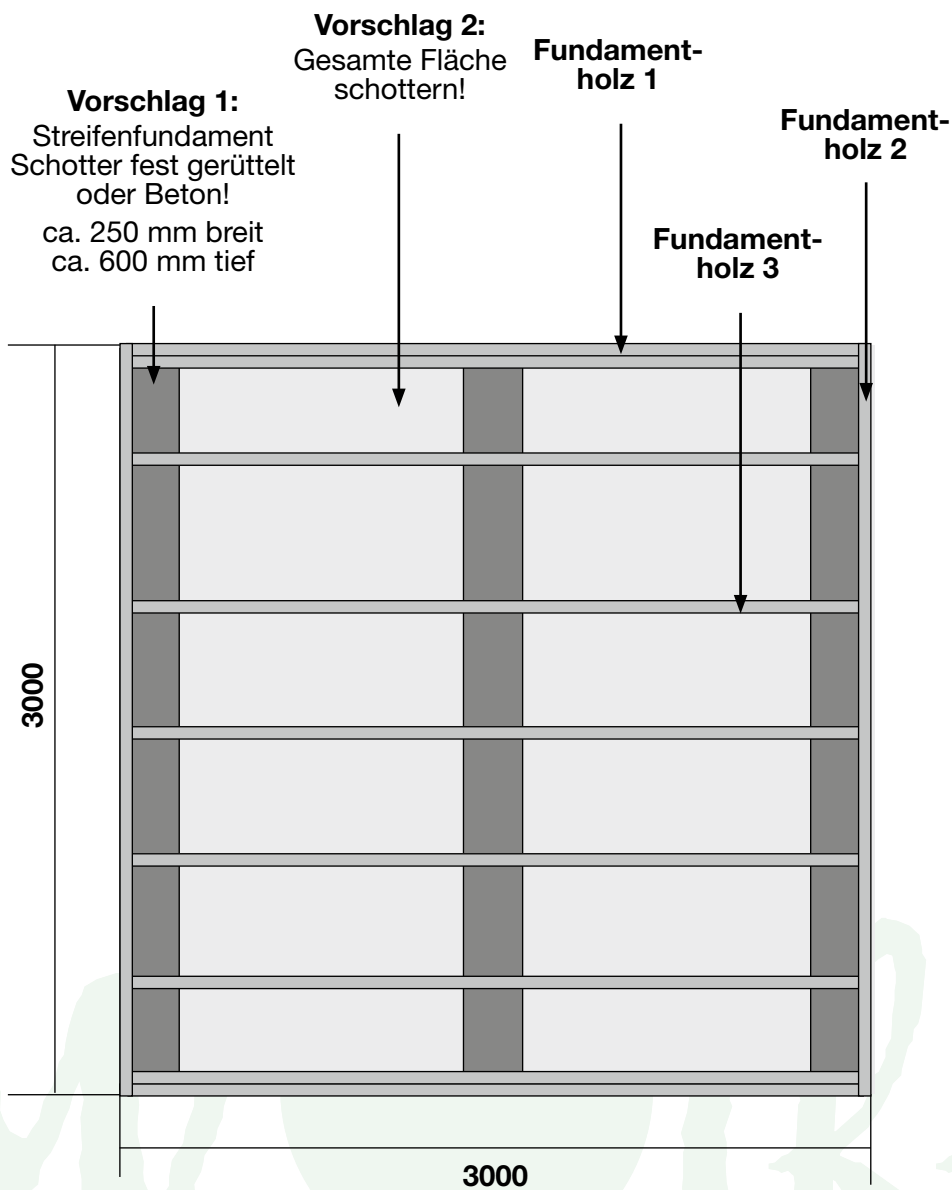

Haustyp	Anzahl der Fundamenthölzer (B x H x L)
Mona 34-B	Fundamentholz 1: 2 (45 x 70 x 2910 mm) Fundamentholz 2: 2 (45 x 70 x 3000 mm) Fundamentholz 3: 7 (45 x 70 x 2910 mm)



Dieser Fundamentplan ist ein unverbindlicher Vorschlag und kann individuell verändert werden!

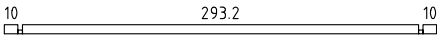
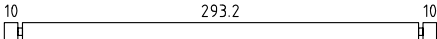
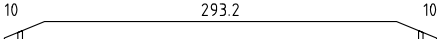
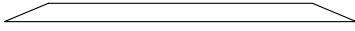
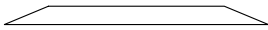
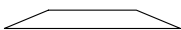

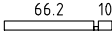
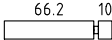
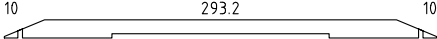
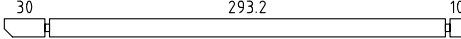
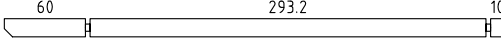
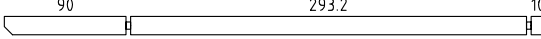
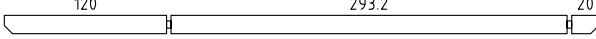
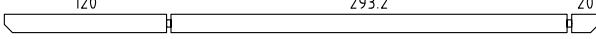
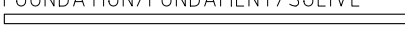
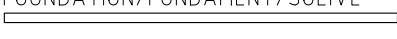
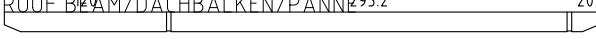

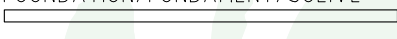





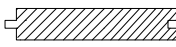

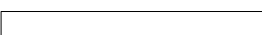

Teileliste 1

Mona 34-B

Pos	Mona 34-B	Stück	Profiil (cm)	Pikkus (cm)
001		1	3.4x6.8	320
002		36	3.4x13.5	320
003		1	3.4x13.5	320
004		2	3.4x13.5	260.6
005		2	3.4x13.5	195.5
006		2	3.4x13.5	130.3
007		2	3.4x13.5	65.2
008		2	3.4x6.8	79.6
009		28	3.4x13.5	79.6
010		1	3.4x13.5	320
011		2	3.4x13.5	340
012		2	3.4x13.5	370
013		2	3.4x13.5	400
014		1	3.4x13.5	440
015		1	3.4x13.5	440
AR1	FOUNDATION/FUNDAMENT/SOLIVE 	2	4.5x7	300
AR2	FOUNDATION/FUNDAMENT/SOLIVE 	2	4.5x7	291
PR1	ROOF BEAM/DACHBALKEN/PANN 	2	4.3x14.5	440
PR2	ROOF BEAM/DACHBALKEN/PANN 	1	4.3x14.5	440
PT1	FOUNDATION/FUNDAMENT/SOLIVE 	7	4.5x9	291
	DOOR 158.8x196.5	1		

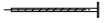
Teileliste 2

Mona 34-B

Pos	Zeichnung Mona 34-B	Stück	Profile (cm)	Länge (cm)
016	FLOOR BOARDS/FUSSBODEN/LAME DE PLANCHER 	26	11.2x1.8	292
		22	13.7x1.8	292
017	ROOF BOARDS/DACHBRETTER/VOLIGE 	80	11.2x1.8	189.5
		65	13.7x1.8	189.5
018	ROOF EDGE REINFORCEMENT/TRAUFENLEISTE/TASSEAU 	2	2.6x3.2	440
019	ROOF SIDE BOARDS/TRAUFENBRETT/PLANCHE DE RIVE 	2	1.8x9	440
020	FASCIA BOARD/GIEBELBLENDE/PLANCHE DE RIVE (FACADE) 	4	1.8x12.0	195
021	FASCIA BOARD/GIEBELBLENDE/PLANCHE DE RIVE (FACADE) 	4	1.8x6.0	195
022	STORM EDGE/STURMLEISTEN/STORM MOLDING 	4	2.6x3.2	200
023	FLOOR EDGE TRIM/FUBLEISTEN/PLINTHE PLANCHER 	4	2.0x4.5	293
024	DIAMOND/RAUTE/DIAMANT 	2	1.8x12	12
025	METAL BOLT/SCHRAUBE/BOLT 	8	M8	8
026	Shim, Nut/Mutter, U-Scheibe/Ecrou,Rondelle - M10 mm - For fixing storm braces/Pour fixer les anti-tempete/Für Sturmleisten 	8	M8	
027	DOOR 142.5x196.5	1		
028	Nails/Nägel/Clous 2.5 x 50 mm - For fixing roofboards Befestigung Dachbretter/P our fixer les voliges 	520		
029	Nails/Nägel/Clous 2.0 40 mm - For fixing roofing felt fillet (18 x 90 mm)/ Befestigung Giebelabschlu ßbrett (18 x 90 mm)/ Pour fixer la latte de finition de la couverture (18 x 90 mm) 	20		
030	Screws/Schrauben/Vis 4 x 50 mm - For fixing roof side boards and roof edge reinforcement/Befestigung Traufenbretter und Traufenleisten Pour fixer les planches de rive et le tasseau (30 x 34 mm) de renfort 	54		
031	Nails/Nägel/Clous 2.5 x 25 mm - For fixing floorboards/ Befestigung Fu ßbodenbretter/Pour fixer les lames de plancher 	182		
032	Nails/Nägel/Clous 1.4 x 40 mm - For fixing floor edge trims (19 x 19 mm)/ Befestigung Fu ßleisten/Pour fixer les plinthes du plancher (19 x 19 mm) 	24		
033	Screws/Schrauben/Vis 4x70 mm - For bearers/ Befestigung Fundamentbalken/Pour fixer les solives 	28		

Wandpläne 1 und 2 Mona 34-B

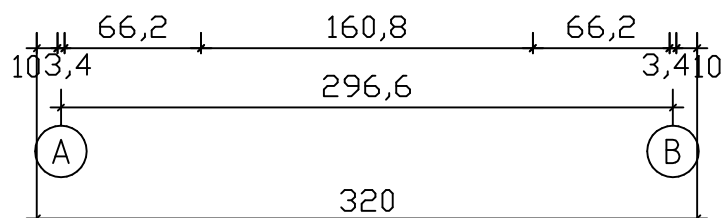
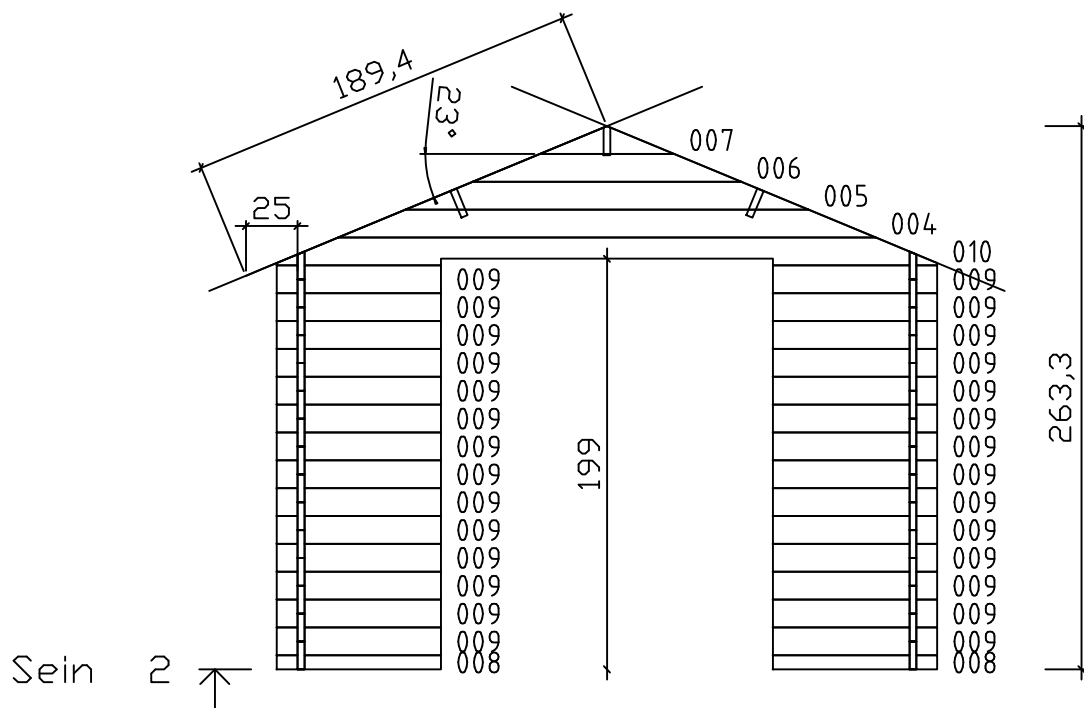
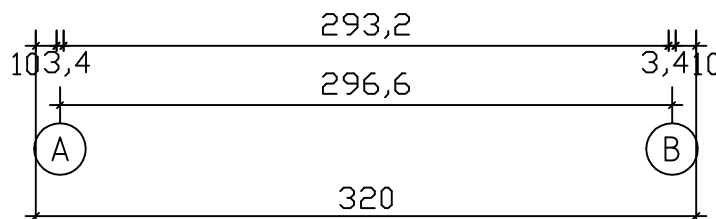
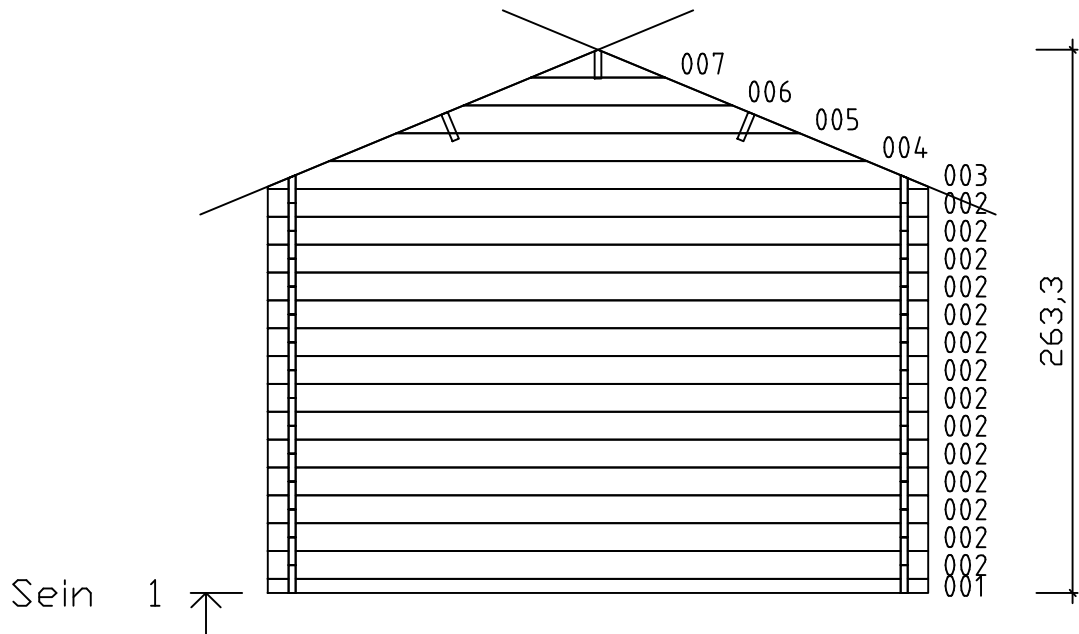

Wandpläne A und B Mona 34-B

