

SCALE 1 : 5

500

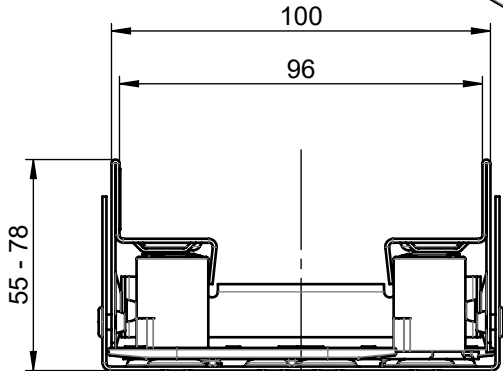

105

ACO

material number: 3006688

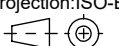
 ACO GmbH Am Ahlmannkai 24782 Büdelsdorf www.aco.com	created by:	drawing-no.: <b>1260610</b>	index: <b>002</b>	documenttype: marketing drw.
	reviewed by:	projection: ISO-E 	scale: 1:2	
title: ACO Profiline ASM Channel for height adjustable 2.0 100x500mm, Type 1, stainless steel ZB Rinne für verstellbare Höhe 2.0 100x500mm Typ 1, Edelstahl				serial-released
The reproduction, distribution and utilization of this document as well as the communication of its contents to others without express authorization is prohibited. Offenders will be held liable for the payment of damages. All rights reserved in the event of the grant of a patent, utility model or design. Observe copyright by ISO 16016			release date: 20.12.2023	sheet: 1/1

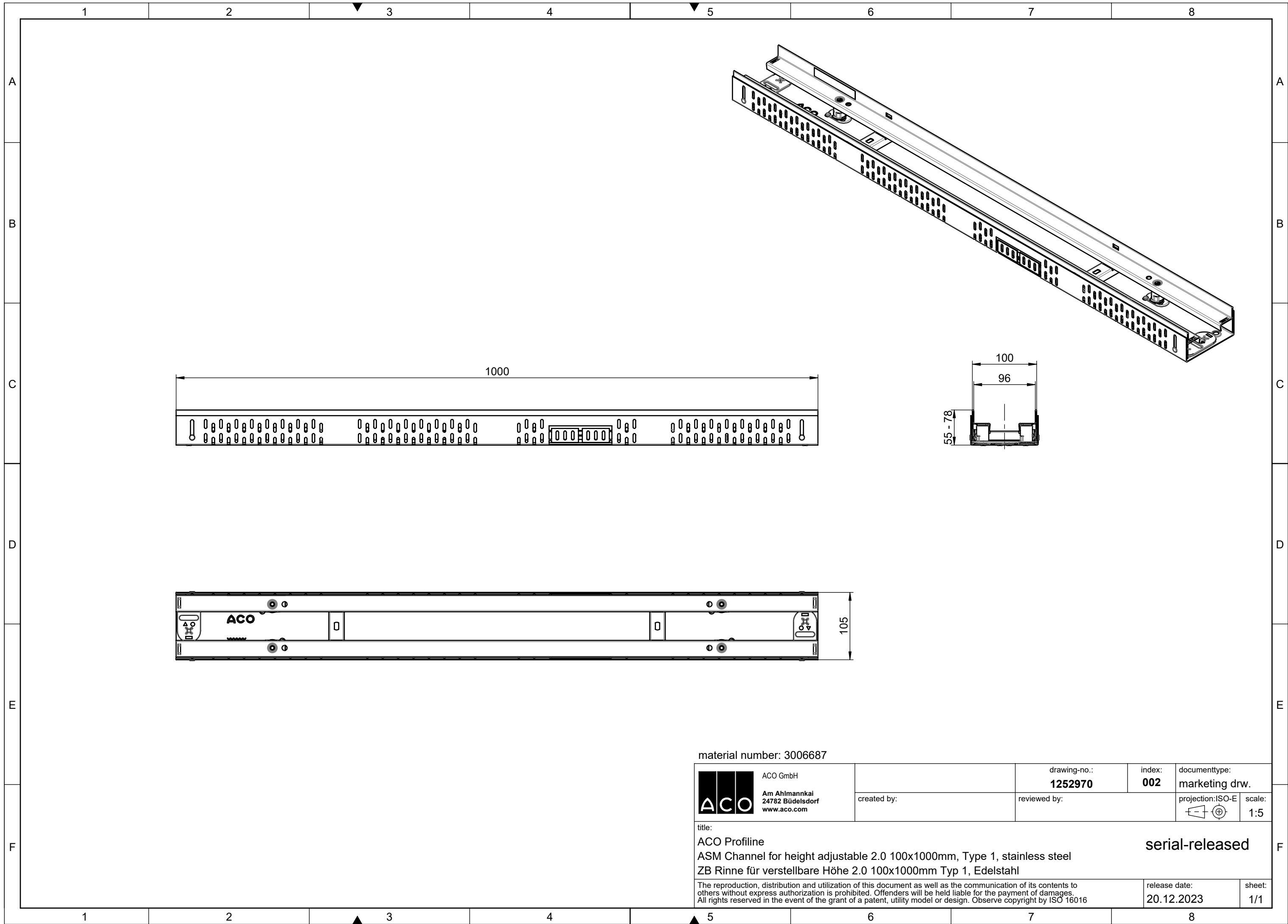

material number: 3006687

 ACO GmbH Am Ahlmannkai 24782 Büdelsdorf www.aco.com	drawing-no.: <b>1252970</b>	index: <b>002</b>	documenttype: marketing drw.
	created by:	reviewed by:	projection: ISO-E 
title: ACO Proflin ASM Channel for height adjustable 2.0 100x1000mm, Type 1, stainless steel ZB Rinne für verstellbare Höhe 2.0 100x1000mm Typ 1, Edelstahl			serial-released
<small>The reproduction, distribution and utilization of this document as well as the communication of its contents to others without express authorization is prohibited. Offenders will be held liable for the payment of damages. All rights reserved in the event of the grant of a patent, utility model or design. Observe copyright by ISO 16016</small>			release date: 20.12.2023
			sheet: 1/1

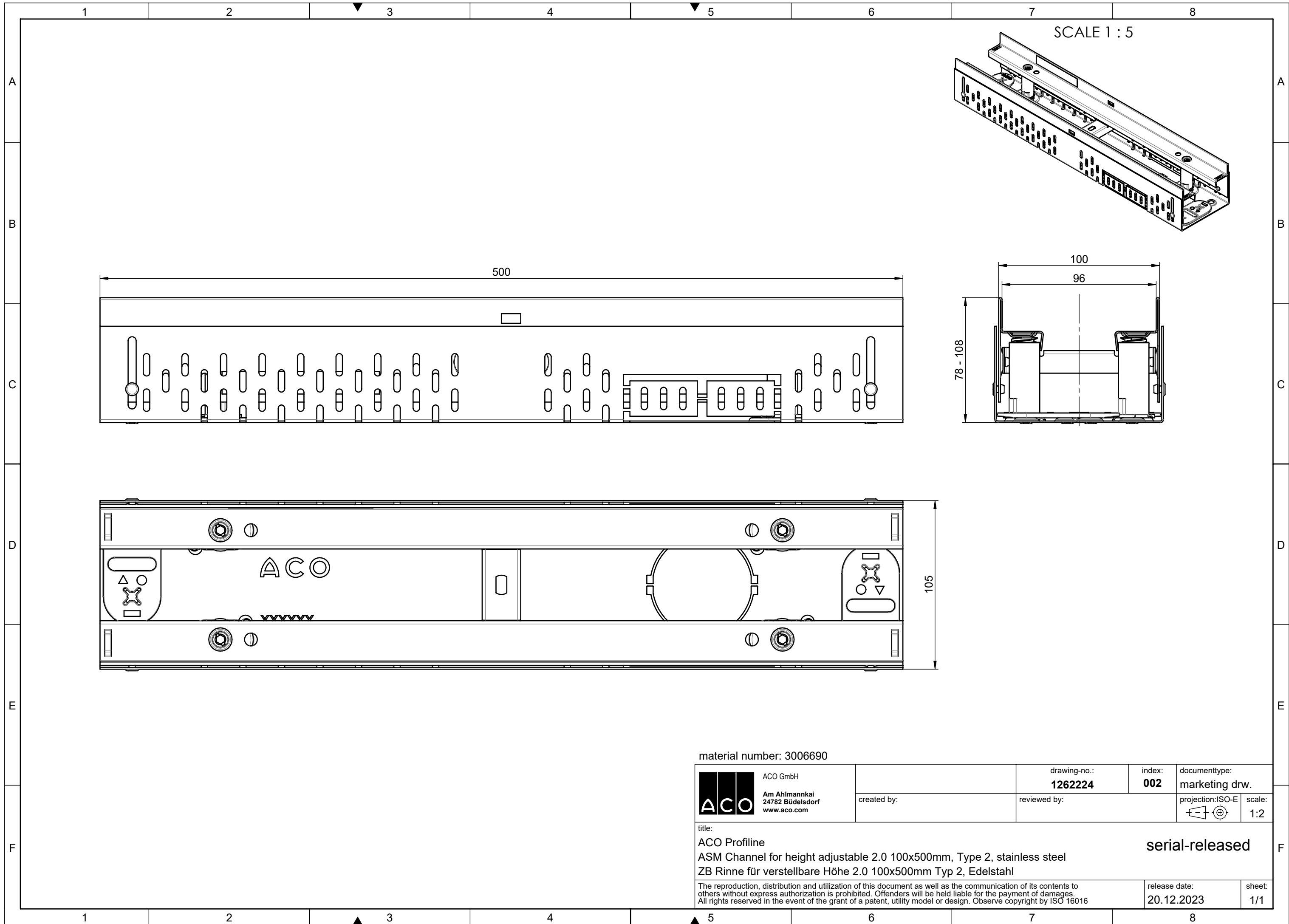

material number: 3006690

 ACO GmbH Am Ahlmannkai 24782 Büdelsdorf www.aco.com	drawing-no.: <b>1262224</b>	index: <b>002</b>	documenttype: marketing drw.
	created by:	reviewed by:	projection: ISO-E 
title: ACO Profiline ASM Channel for height adjustable 2.0 100x500mm, Type 2, stainless steel ZB Rinne für verstellbare Höhe 2.0 100x500mm Typ 2, Edelstahl			serial-released
<small>The reproduction, distribution and utilization of this document as well as the communication of its contents to others without express authorization is prohibited. Offenders will be held liable for the payment of damages. All rights reserved in the event of the grant of a patent, utility model or design. Observe copyright by ISO 16016</small>			release date: 20.12.2023
			sheet: 1/1

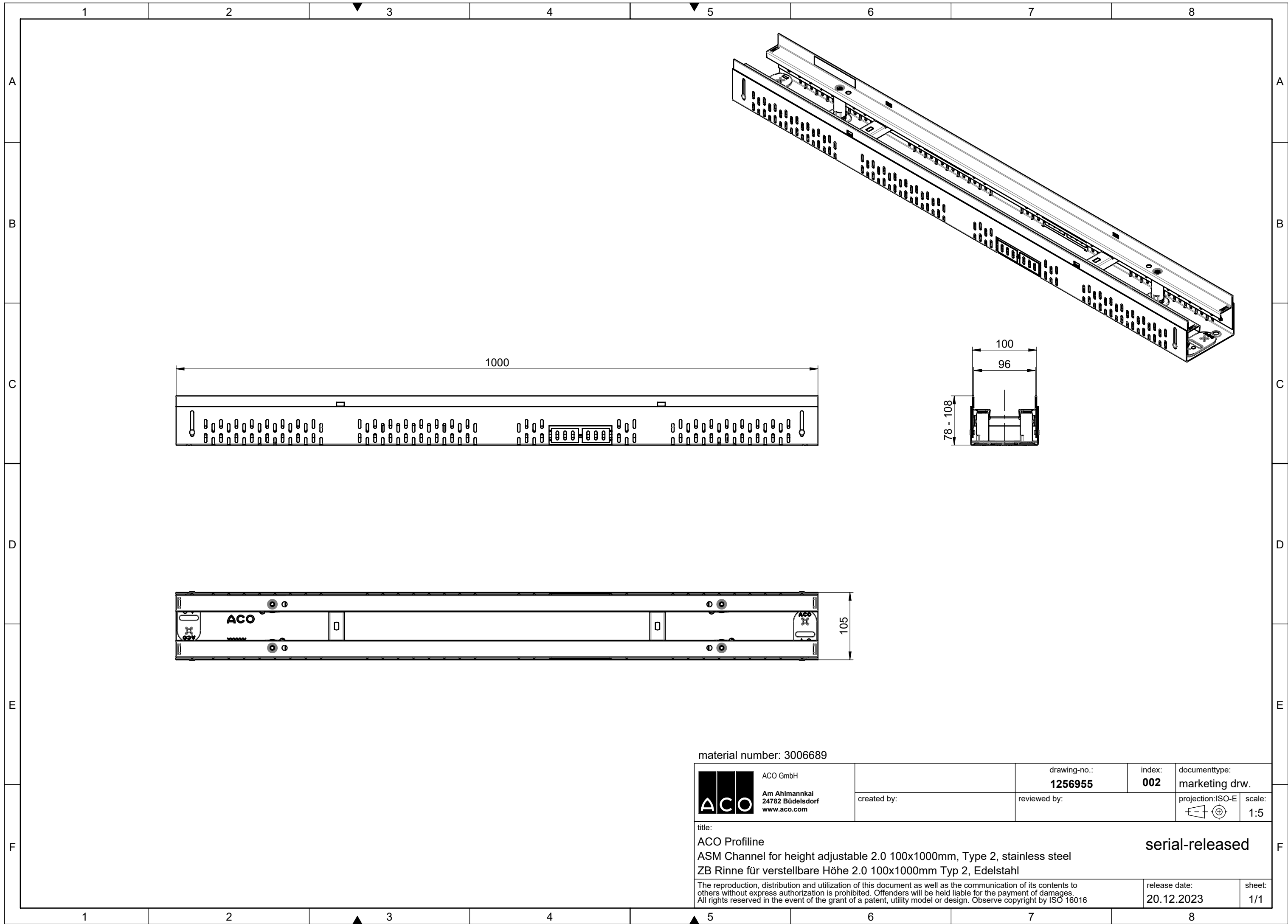

material number: 3006689

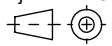
 ACO GmbH Am Ahlmannkai 24782 Büdelsdorf www.aco.com	drawing-no.: <b>1256955</b>	index: <b>002</b>	documenttype: marketing drw.
	created by:	reviewed by:	projection: ISO-E 
title: ACO Profiline ASM Channel for height adjustable 2.0 100x1000mm, Type 2, stainless steel ZB Rinne für verstellbare Höhe 2.0 100x1000mm Typ 2, Edelstahl			serial-released
<small>The reproduction, distribution and utilization of this document as well as the communication of its contents to others without express authorization is prohibited. Offenders will be held liable for the payment of damages. All rights reserved in the event of the grant of a patent, utility model or design. Observe copyright by ISO 16016</small>			release date: 20.12.2023
			sheet: 1/1

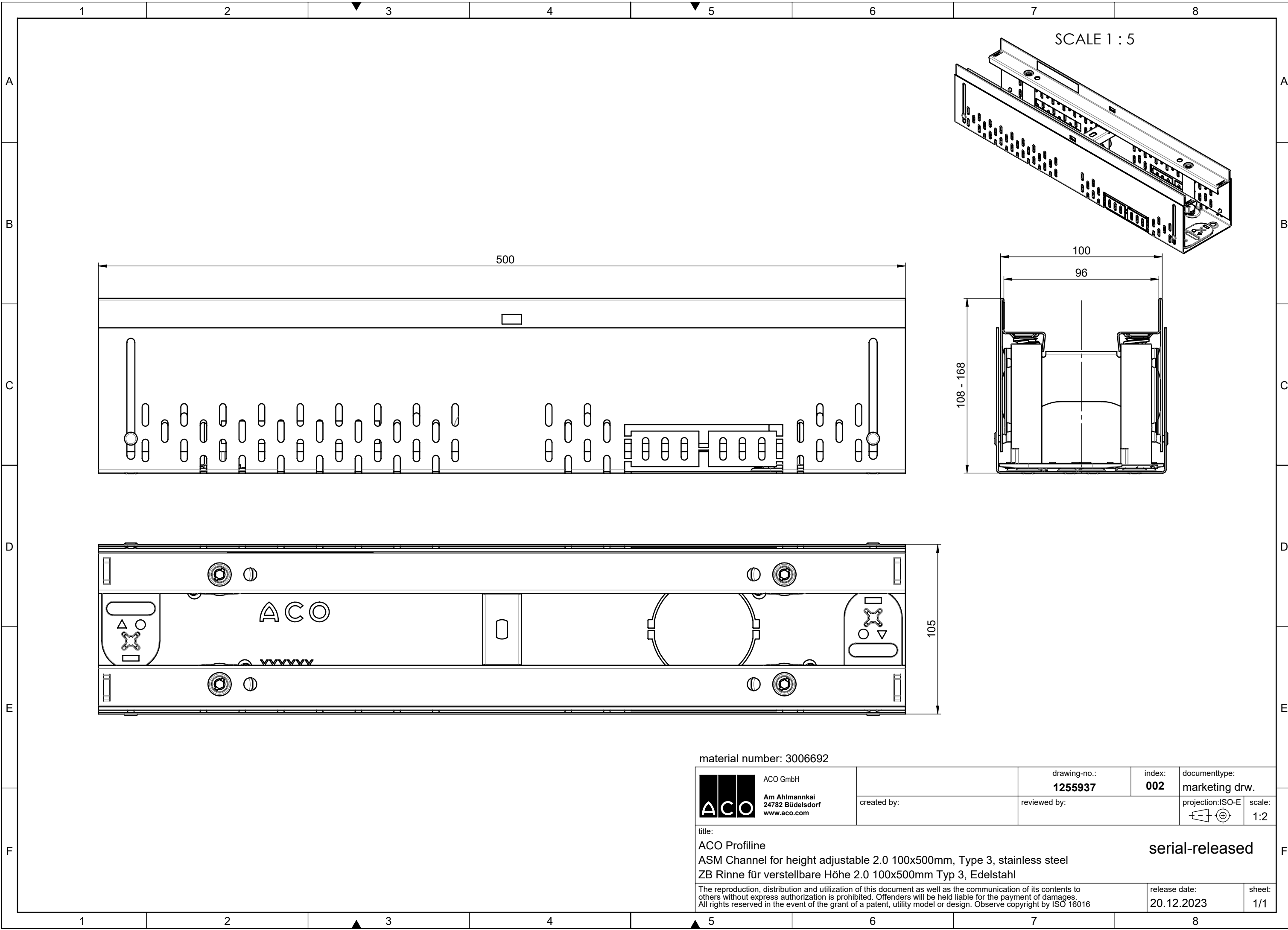

SCALE 1 : 5

500

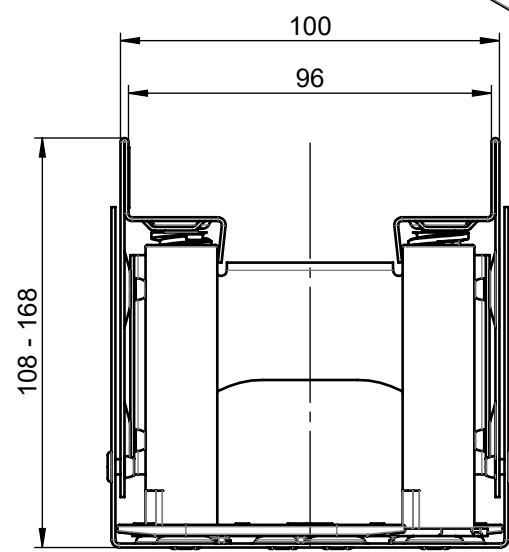

105

ACO

material number: 3006692

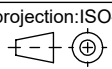
 ACO GmbH Am Ahlmannkai 24782 Büdelsdorf www.aco.com	drawing-no.: <b>1255937</b>	index: <b>002</b>	documenttype: marketing drw.
	created by:	reviewed by:	projection: ISO-E 
title: ACO Profiline ASM Channel for height adjustable 2.0 100x500mm, Type 3, stainless steel ZB Rinne für verstellbare Höhe 2.0 100x500mm Typ 3, Edelstahl			serial-released
<small>The reproduction, distribution and utilization of this document as well as the communication of its contents to others without express authorization is prohibited. Offenders will be held liable for the payment of damages. All rights reserved in the event of the grant of a patent, utility model or design. Observe copyright by ISO 16016</small>			release date: 20.12.2023
			sheet: 1/1

S:\projekte\2019\001\_A3\_Versio22

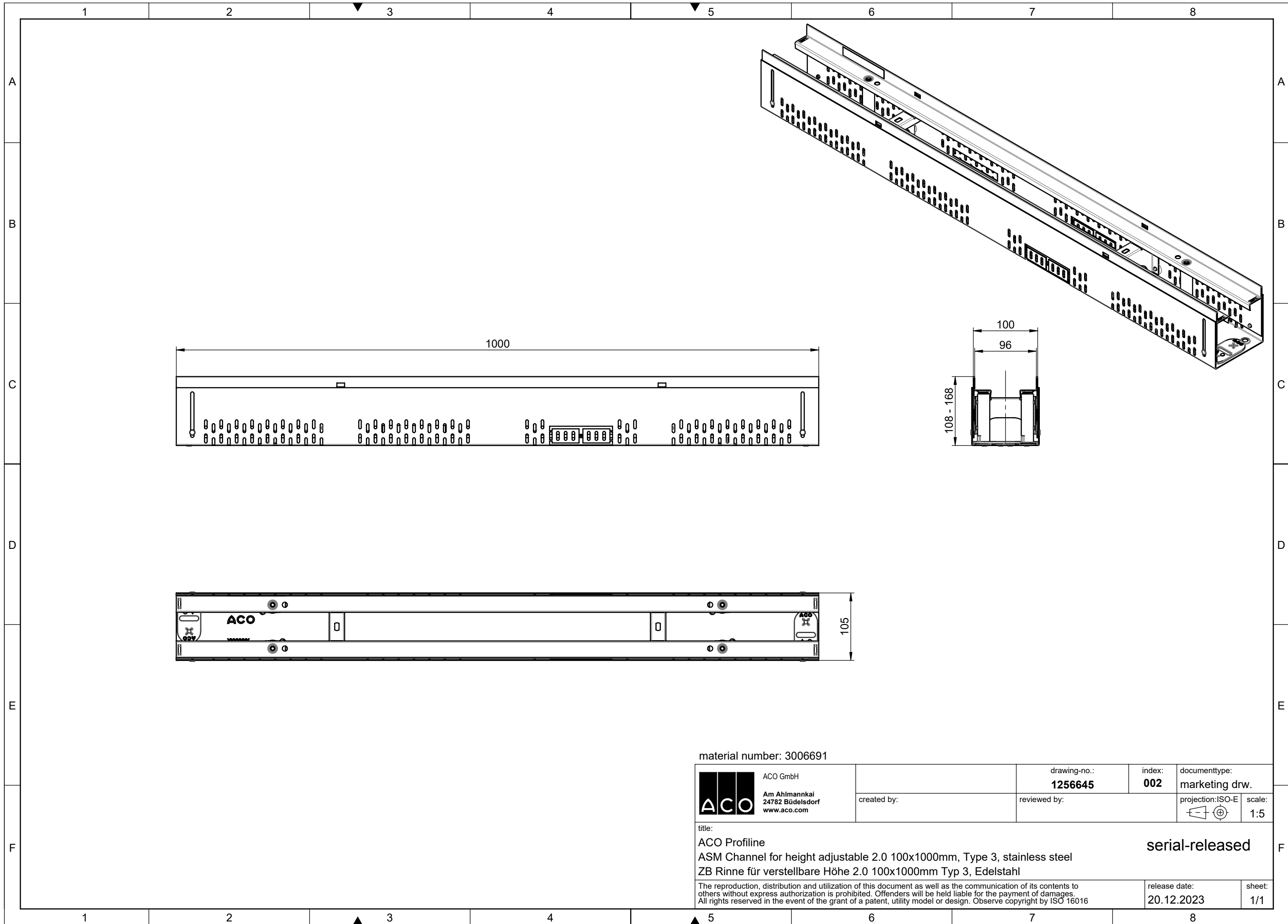

material number: 3006691

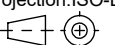
 ACO GmbH Am Ahlmannkai 24782 Büdelsdorf www.aco.com	drawing-no.: <b>1256645</b>	index: <b>002</b>	documenttype: marketing drw.	
	created by:	reviewed by:	projection: ISO-E 	scale: 1:5
title: ACO Profiline ASM Channel for height adjustable 2.0 100x1000mm, Type 3, stainless steel ZB Rinne für verstellbare Höhe 2.0 100x1000mm Typ 3, Edelstahl			serial-released	
<small>The reproduction, distribution and utilization of this document as well as the communication of its contents to others without express authorization is prohibited. Offenders will be held liable for the payment of damages. All rights reserved in the event of the grant of a patent, utility model or design. Observe copyright by ISO 16016</small>			release date: 20.12.2023	sheet: 1/1

S:\projekte\2019\001\_A3\_Versatz\_22

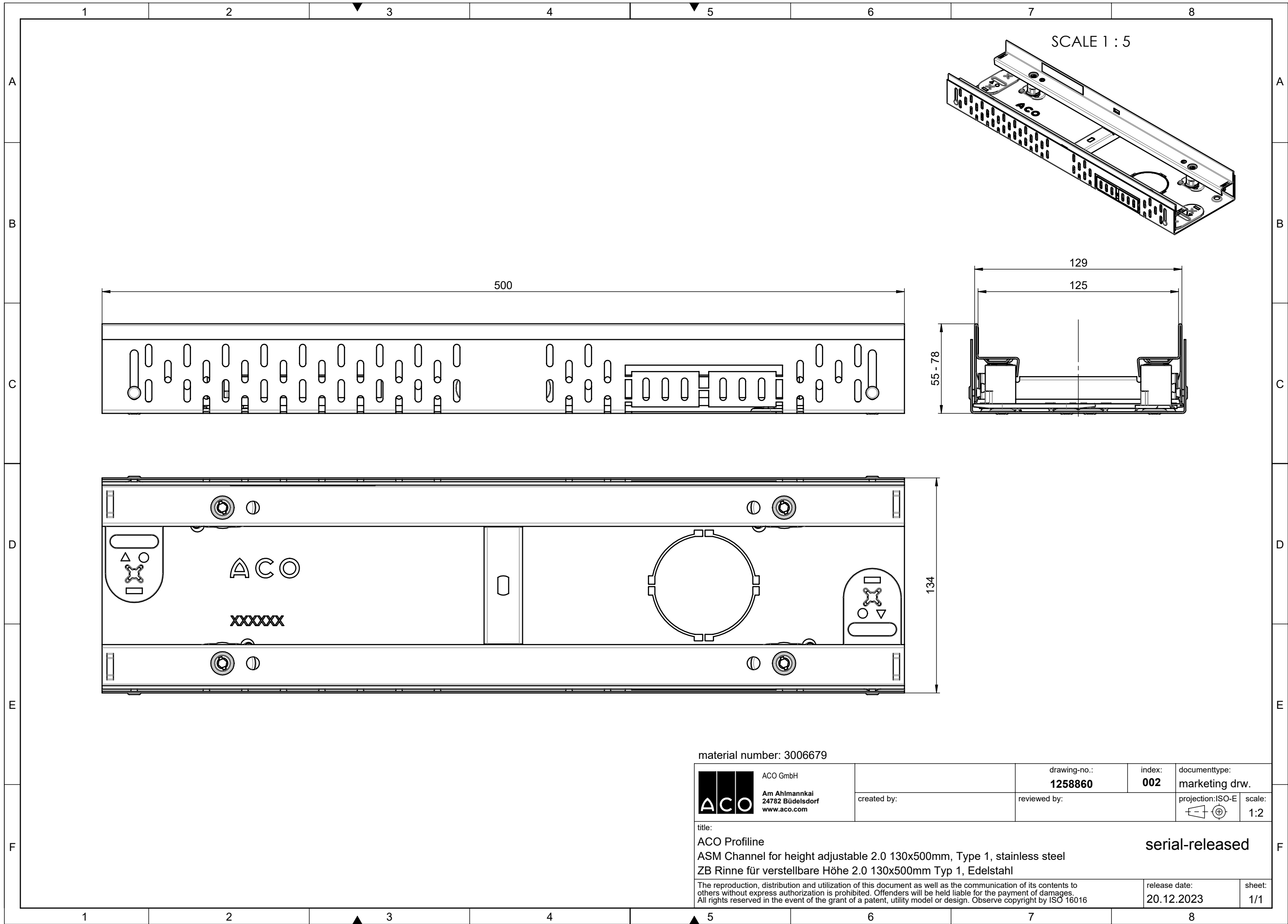

SCALE 1 : 5

500

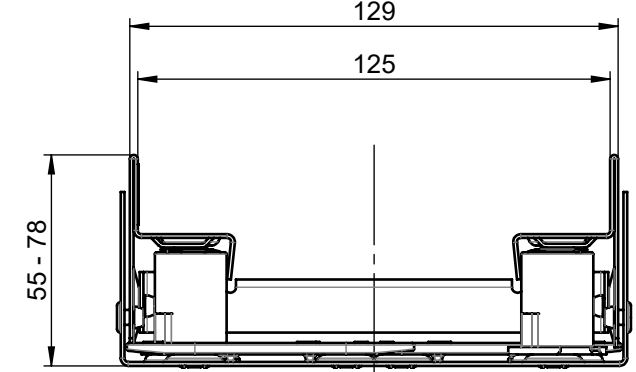

55 - 78

129

125

134

ACO

XXXXXX

material number: 3006679

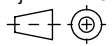
 ACO GmbH Am Ahlmannkai 24782 Büdelsdorf www.aco.com	drawing-no.: <b>1258860</b>	index: <b>002</b>	documenttype: marketing drw.
	created by:	reviewed by:	projection: ISO-E 
title: ACO Proffline ASM Channel for height adjustable 2.0 130x500mm, Type 1, stainless steel ZB Rinne für verstellbare Höhe 2.0 130x500mm Typ 1, Edelstahl			serial-released
<small>The reproduction, distribution and utilization of this document as well as the communication of its contents to others without express authorization is prohibited. Offenders will be held liable for the payment of damages. All rights reserved in the event of the grant of a patent, utility model or design. Observe copyright by ISO 16016</small>			release date: 20.12.2023
			sheet: 1/1

S:\projekte\2019\001\_A3\_Versatz\_22

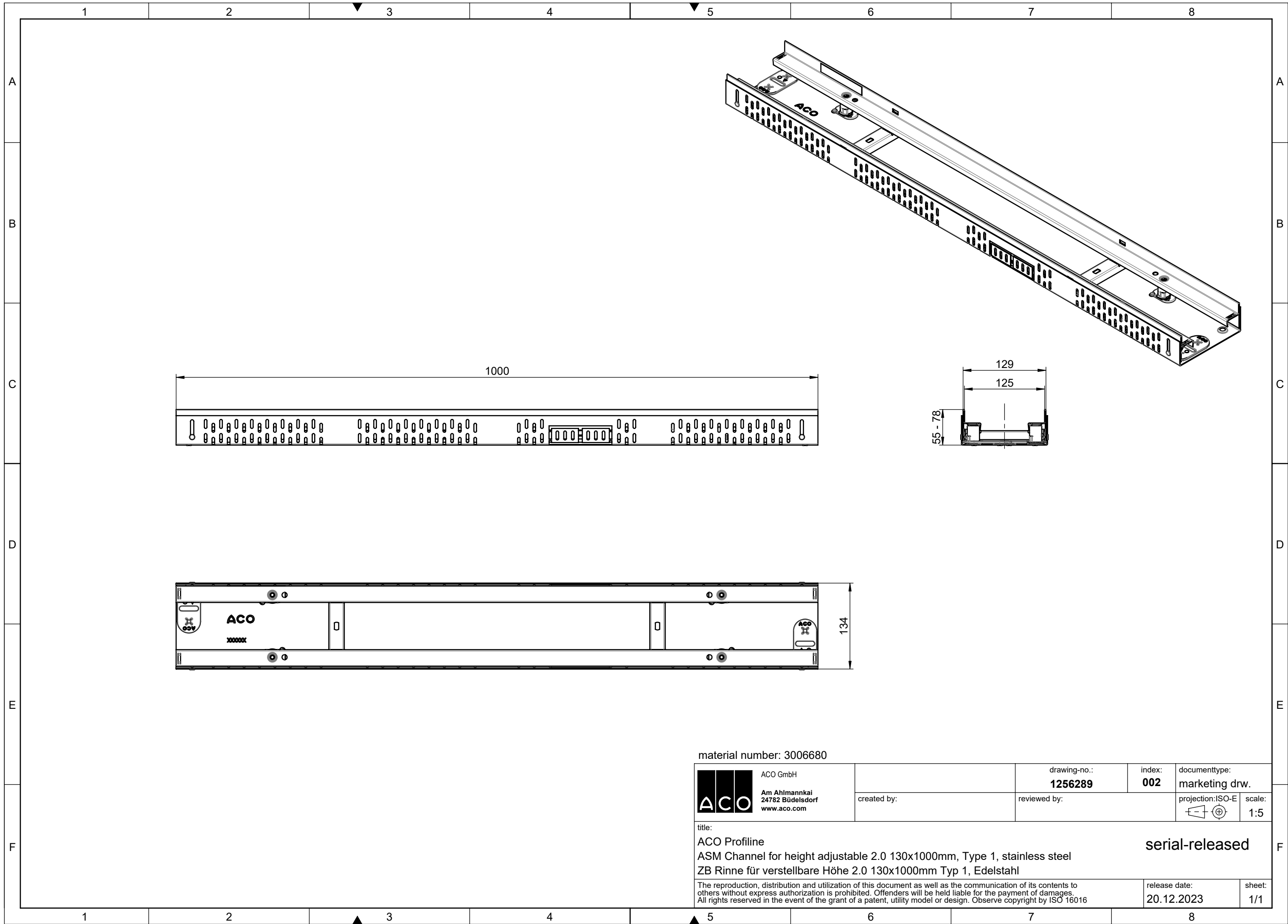

material number: 3006680

**ACO** GmbH  
 Am Ahlmannkai  
 24782 Büdelsdorf  
 www.aco.com

created by:

drawing-no.: **1256289**  
 reviewed by:

index: **002**  
 documenttype: **marketing drw.**  
 projection: ISO-E  
 scale: **1:5**

title:  
**ACO Profiline**  
**ASM Channel for height adjustable 2.0 130x1000mm, Type 1, stainless steel**  
**ZB Rinne für verstellbare Höhe 2.0 130x1000mm Typ 1, Edelstahl**

**serial-released**

The reproduction, distribution and utilization of this document as well as the communication of its contents to others without express authorization is prohibited. Offenders will be held liable for the payment of damages. All rights reserved in the event of the grant of a patent, utility model or design. Observe copyright by ISO 16016

release date: **20.12.2023**      sheet: **1/1**



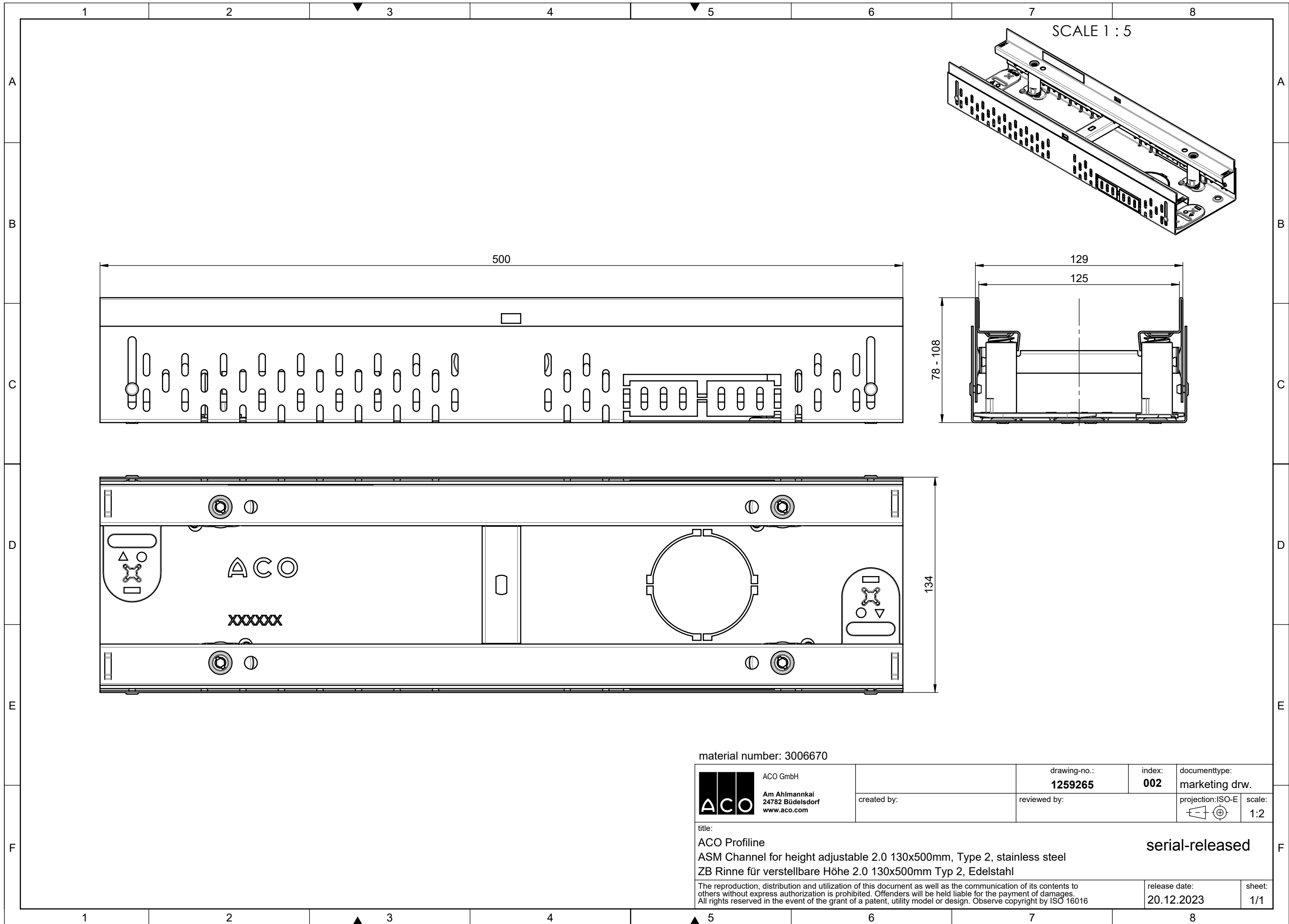

SCALE 1 : 5

500

129  
125  
78 - 108

134

ACO

XXXXXX

material number: 3006670

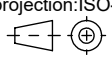
 ACO GmbH Am Ahlmannkai 24782 Büdelsdorf www.aco.com	drawing-no.: <b>1259265</b>	index: <b>002</b>	documenttype: marketing drw.
	created by:	reviewed by:	projection: ISO-E 
title: ACO Profiline ASM Channel for height adjustable 2.0 130x500mm, Type 2, stainless steel ZB Rinne für verstellbare Höhe 2.0 130x500mm Typ 2, Edelstahl			serial-released
The reproduction, distribution and utilization of this document as well as the communication of its contents to others without express authorization is prohibited. Offenders will be held liable for the payment of damages. All rights reserved in the event of the grant of a patent, utility model or design. Observe copyright by ISO 16016			release date: 20.12.2023
			sheet: 1/1

S:\projekte\2019\081\_A3\_Versio22

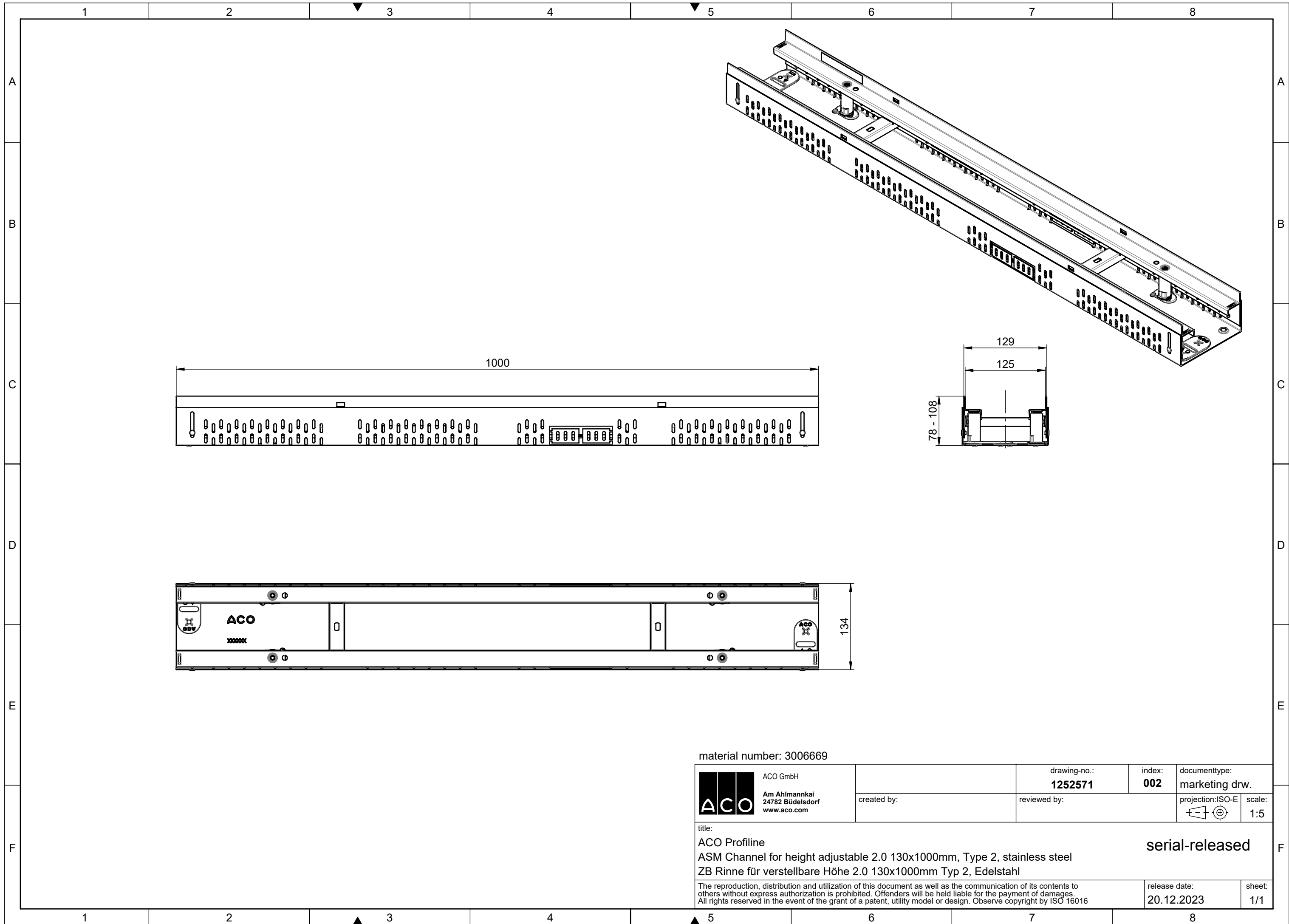

material number: 3006669

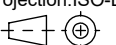
 ACO GmbH Am Ahlmannkai 24782 Büdelsdorf www.aco.com	drawing-no.: <b>1252571</b>	index: <b>002</b>	documenttype: marketing drw.
	created by:	reviewed by:	projection: ISO-E 
title: ACO Profiline ASM Channel for height adjustable 2.0 130x1000mm, Type 2, stainless steel ZB Rinne für verstellbare Höhe 2.0 130x1000mm Typ 2, Edelstahl			serial-released
<small>The reproduction, distribution and utilization of this document as well as the communication of its contents to others without express authorization is prohibited. Offenders will be held liable for the payment of damages. All rights reserved in the event of the grant of a patent, utility model or design. Observe copyright by ISO 16016</small>			release date: 20.12.2023
			sheet: 1/1

S:\projekte\2019\001\_A3\_Vertrieb\22

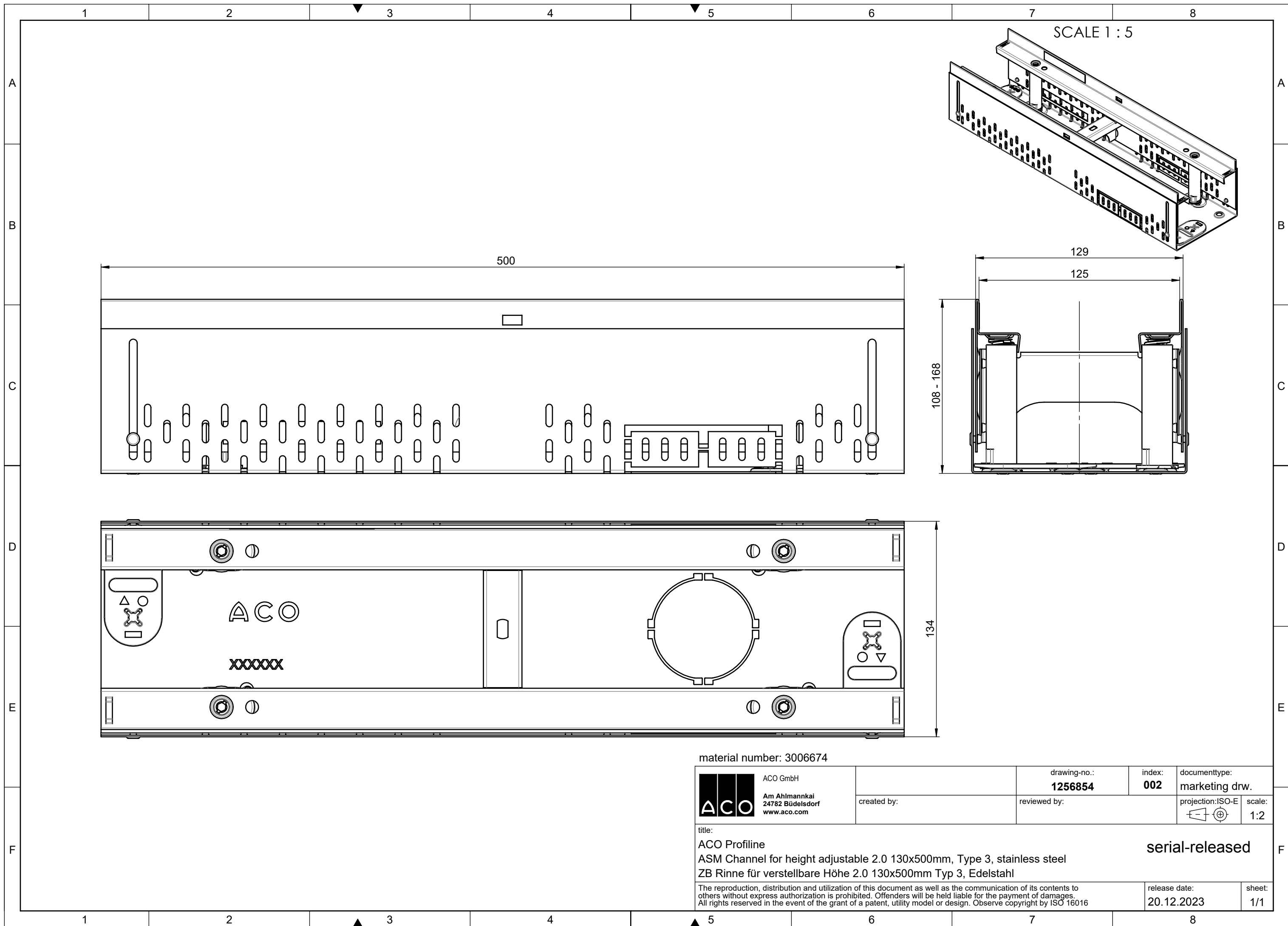

material number: 3006674

 ACO GmbH Am Ahlmannkai 24782 Büdelsdorf www.aco.com	created by:	drawing-no.: <b>1256854</b>	index: <b>002</b>	documenttype: marketing drw.
	reviewed by:	projection: ISO-E	scale: 1:2	
title: ACO Proffline ASM Channel for height adjustable 2.0 130x500mm, Type 3, stainless steel ZB Rinne für verstellbare Höhe 2.0 130x500mm Typ 3, Edelstahl				serial-released
The reproduction, distribution and utilization of this document as well as the communication of its contents to others without express authorization is prohibited. Offenders will be held liable for the payment of damages. All rights reserved in the event of the grant of a patent, utility model or design. Observe copyright by ISO 16016			release date: 20.12.2023	sheet: 1/1

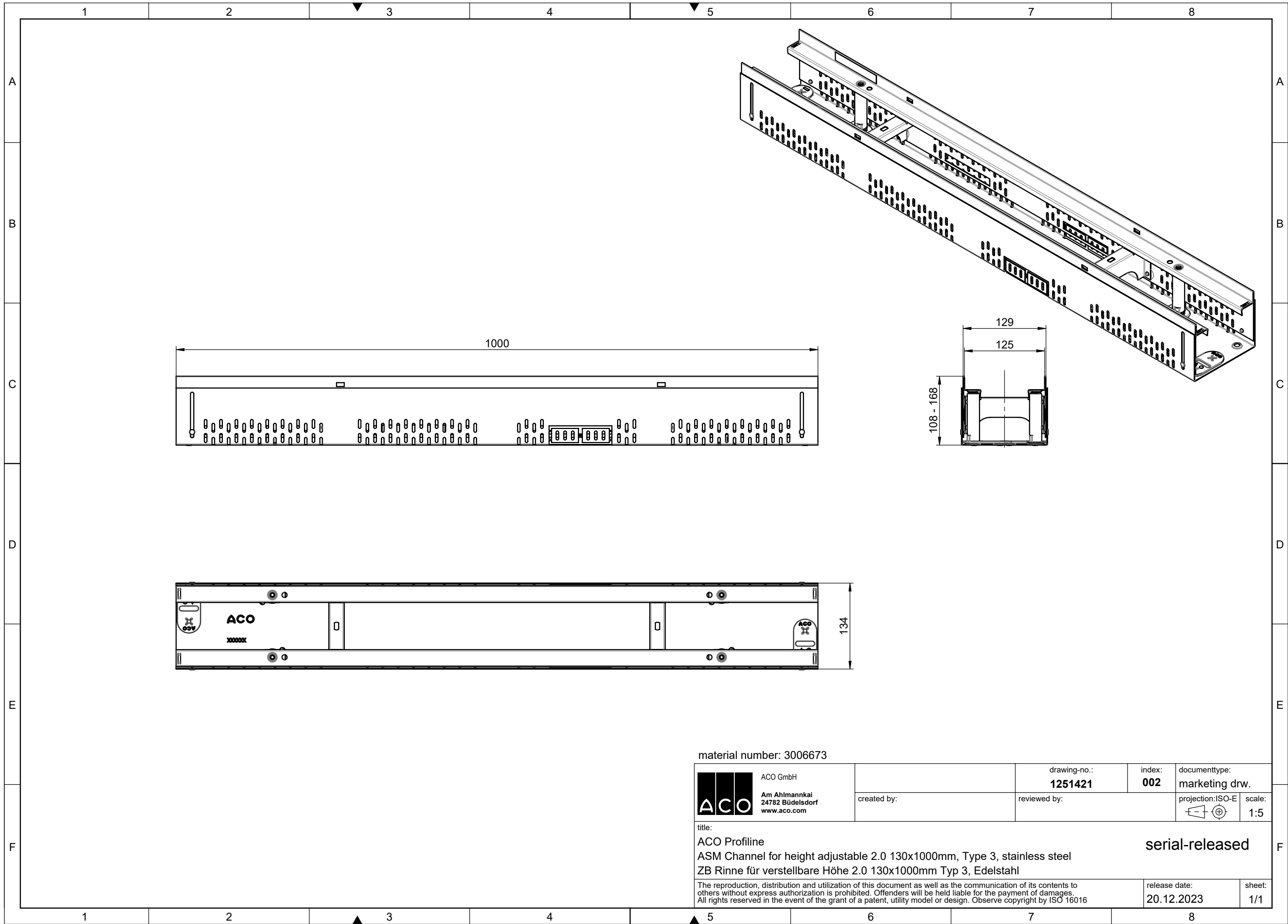

material number: 3006673

**ACO** GmbH  
 Am Ahlmannkai  
 24782 Büdelsdorf  
 www.aco.com

drawing-no.:  
**1251421**

created by:

index:  
**002**

reviewed by:

documenttype:  
 marketing drw.

projection: ISO-E

scale:  
 1:5

title:  
 ACO Proffline  
 ASM Channel for height adjustable 2.0 130x1000mm, Type 3, stainless steel  
 ZB Rinne für verstellbare Höhe 2.0 130x1000mm Typ 3, Edelstahl

**serial-released**

The reproduction, distribution and utilization of this document as well as the communication of its contents to others without express authorization is prohibited. Offenders will be held liable for the payment of damages. All rights reserved in the event of the grant of a patent, utility model or design. Observe copyright by ISO 16016

release date:  
 20.12.2023

sheet:  
 1/1

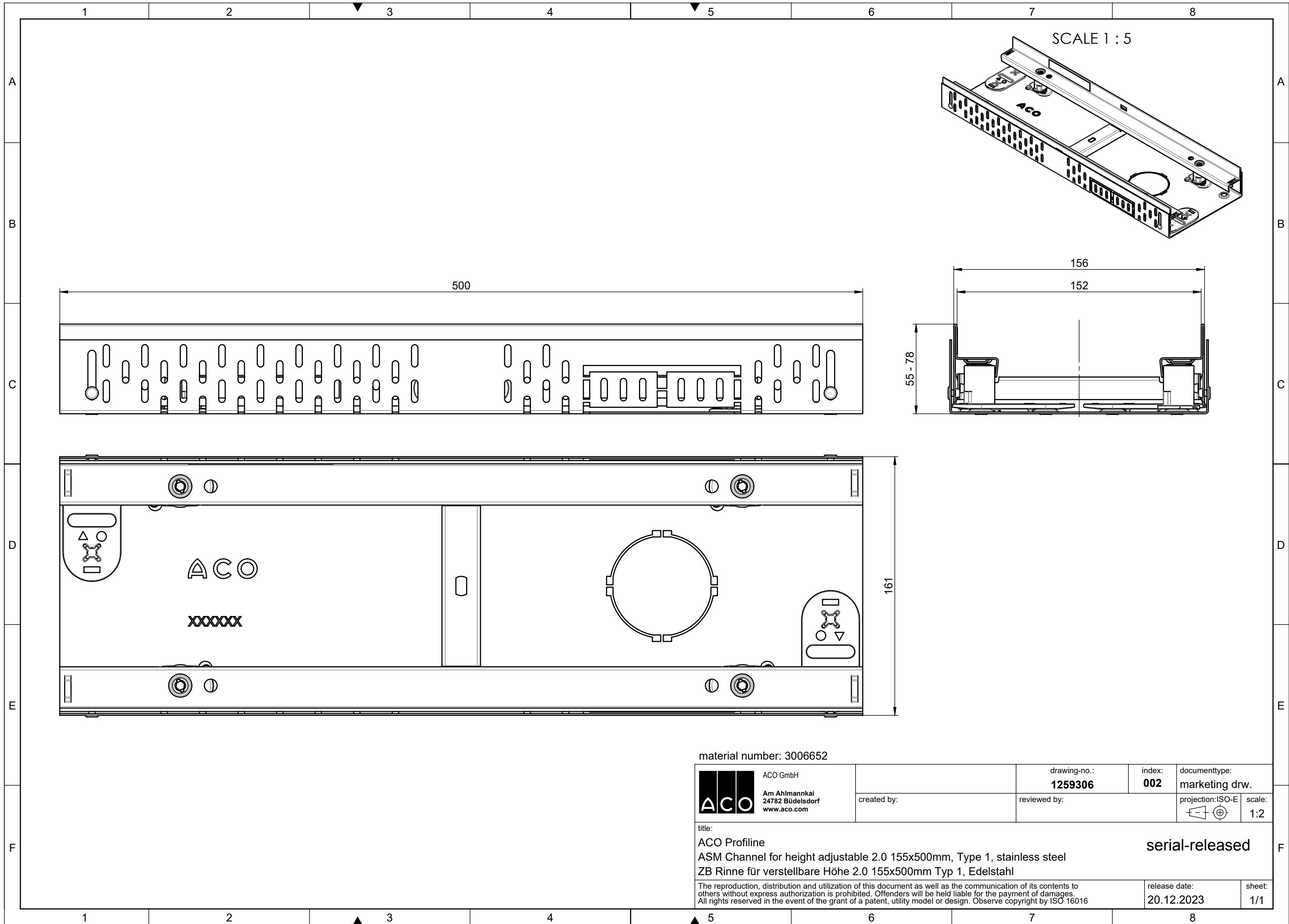

material number: 3006652

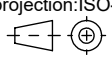
 ACO GmbH Am Ahlmannkai 24782 Büdelsdorf www.aco.com	drawing-no.: <b>1259306</b>	index: <b>002</b>	documenttype: marketing drw.
	created by:	reviewed by:	projection: ISO-E  scale: 1:2
title: ACO Profiline ASM Channel for height adjustable 2.0 155x500mm, Type 1, stainless steel ZB Rinne für verstellbare Höhe 2.0 155x500mm Typ 1, Edelstahl			serial-released
<small>The reproduction, distribution and utilization of this document as well as the communication of its contents to others without express authorization is prohibited. Offenders will be held liable for the payment of damages. All rights reserved in the event of the grant of a patent, utility model or design. Observe copyright by ISO 16016</small>			release date: <b>20.12.2023</b>
			sheet: <b>1/1</b>

S:\projekte\2019\001\_A3\_Versio22

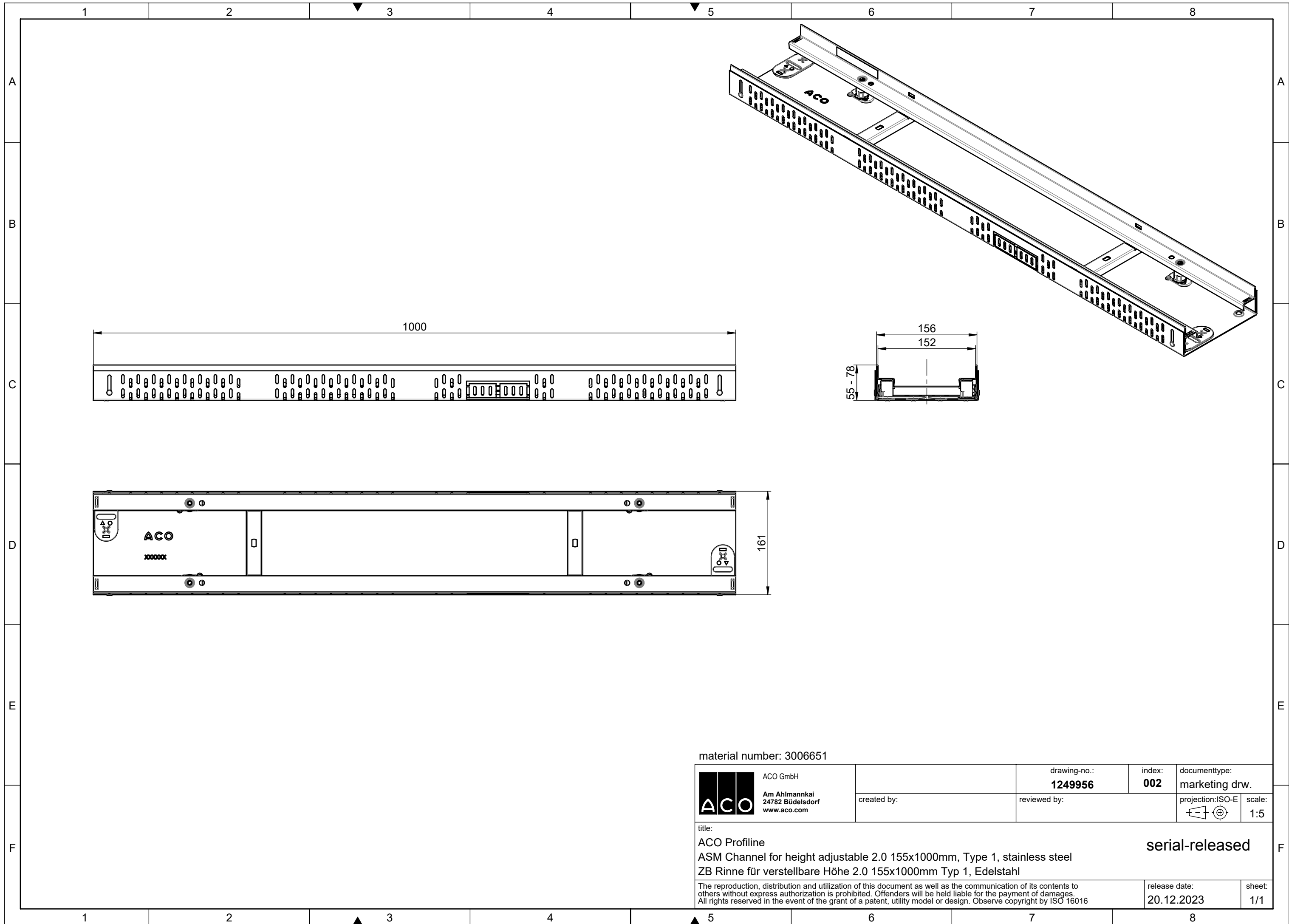

material number: 3006651

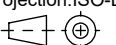
 ACO GmbH Am Ahlmannkai 24782 Büdelsdorf www.aco.com	drawing-no.: <b>1249956</b>	index: <b>002</b>	documenttype: marketing drw.
	created by:	reviewed by:	projection: ISO-E 
title: ACO Profiline ASM Channel for height adjustable 2.0 155x1000mm, Type 1, stainless steel ZB Rinne für verstellbare Höhe 2.0 155x1000mm Typ 1, Edelstahl			serial-released
<small>The reproduction, distribution and utilization of this document as well as the communication of its contents to others without express authorization is prohibited. Offenders will be held liable for the payment of damages. All rights reserved in the event of the grant of a patent, utility model or design. Observe copyright by ISO 16016</small>			release date: 20.12.2023
			sheet: 1/1

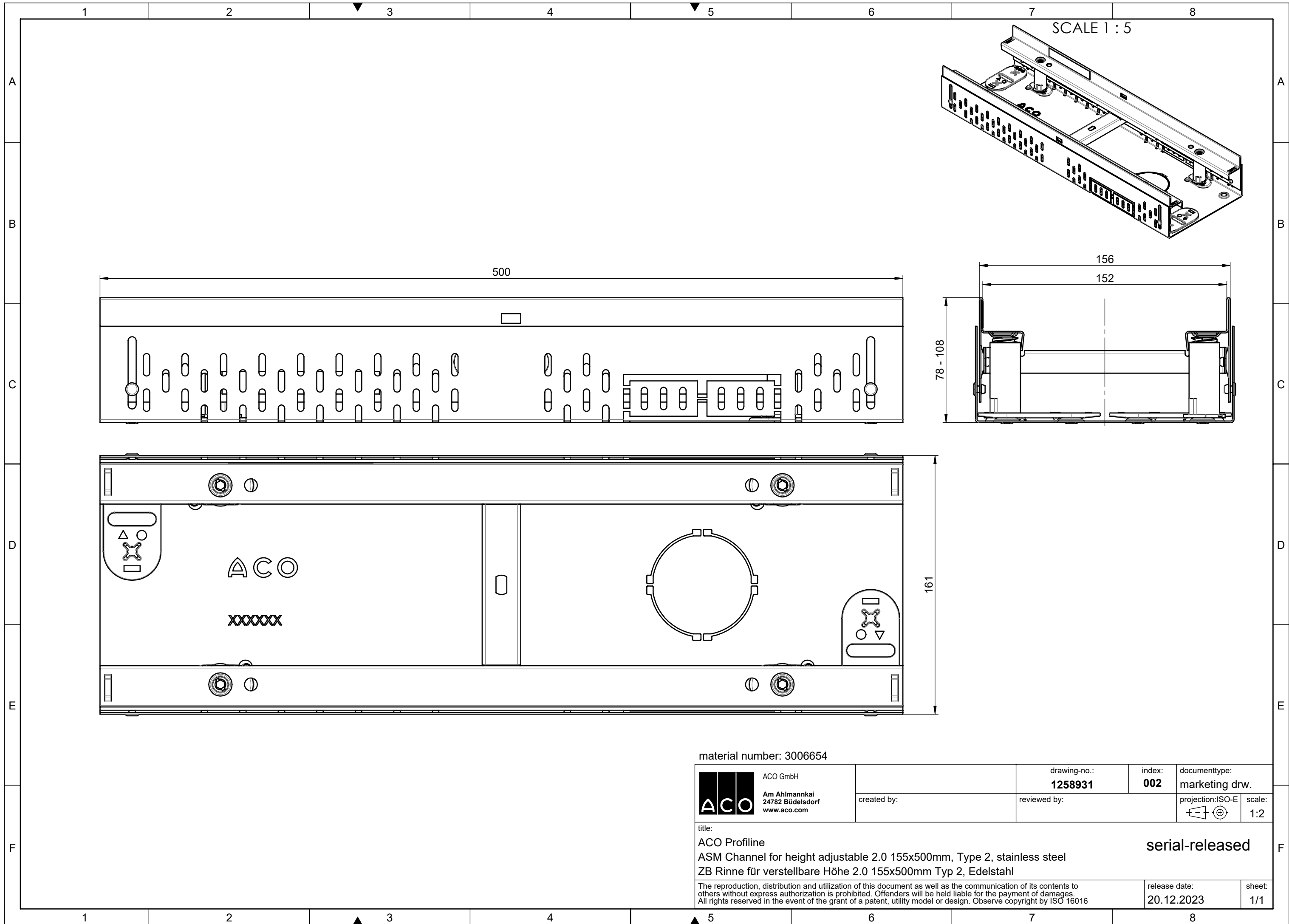

material number: 3006654

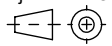
 ACO GmbH Am Ahlmannkai 24782 Büdelsdorf www.aco.com	created by:	drawing-no.: <b>1258931</b>	index: <b>002</b>	documenttype: marketing drw.
	reviewed by:	 scale: 1:2		
title: ACO Profiline ASM Channel for height adjustable 2.0 155x500mm, Type 2, stainless steel ZB Rinne für verstellbare Höhe 2.0 155x500mm Typ 2, Edelstahl				serial-released
The reproduction, distribution and utilization of this document as well as the communication of its contents to others without express authorization is prohibited. Offenders will be held liable for the payment of damages. All rights reserved in the event of the grant of a patent, utility model or design. Observe copyright by ISO 16016			release date: 20.12.2023	sheet: 1/1

S:\projekte\2019\001\_A3\_Versio22

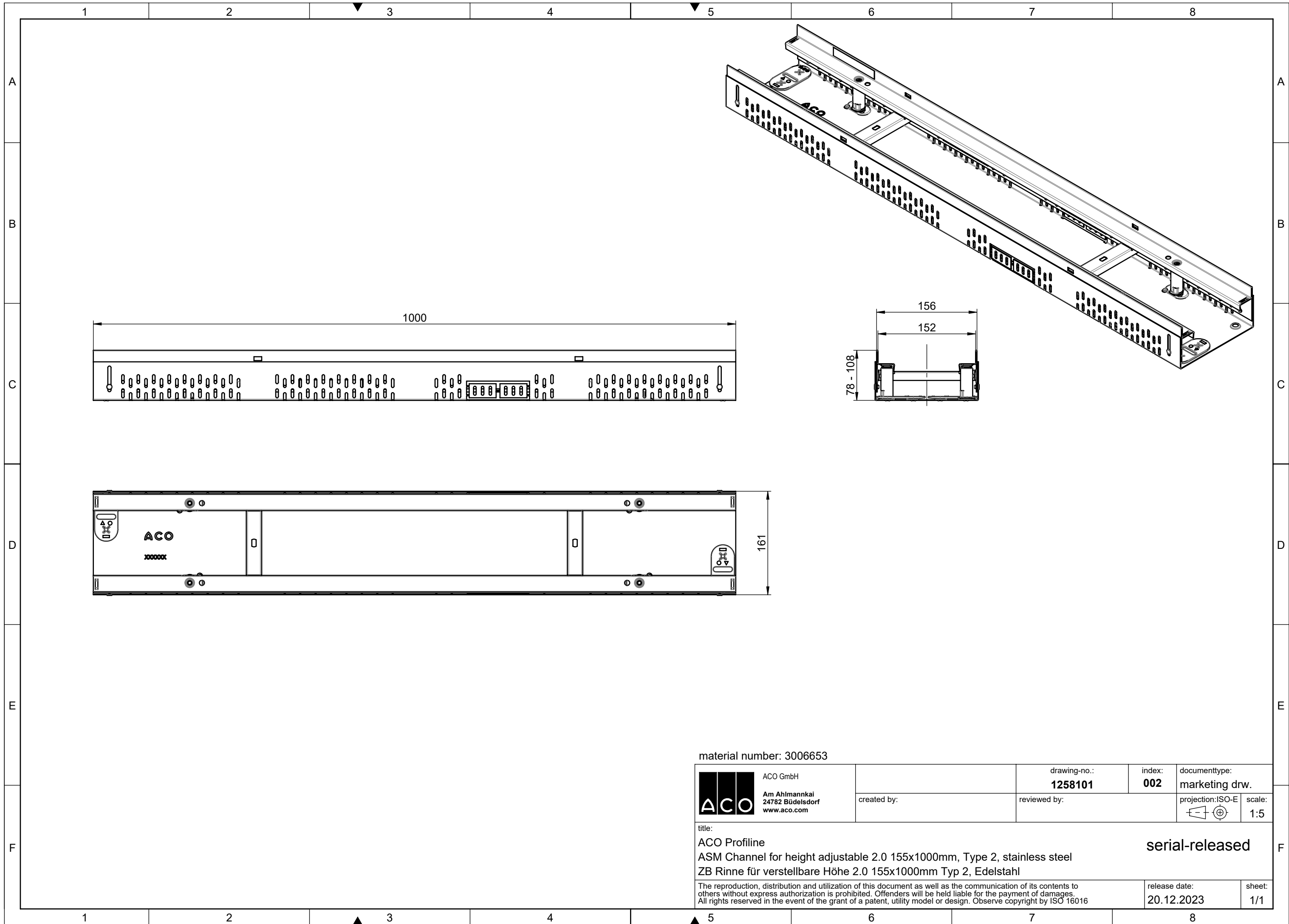

material number: 3006653

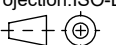
 ACO GmbH Am Ahlmannkai 24782 Büdelsdorf www.aco.com	drawing-no.: <b>1258101</b>	index: <b>002</b>	documenttype: marketing drw.
	created by:	reviewed by:	projection: ISO-E  scale: 1:5
title: ACO Proffline ASM Channel for height adjustable 2.0 155x1000mm, Type 2, stainless steel ZB Rinne für verstellbare Höhe 2.0 155x1000mm Typ 2, Edelstahl			serial-released
The reproduction, distribution and utilization of this document as well as the communication of its contents to others without express authorization is prohibited. Offenders will be held liable for the payment of damages. All rights reserved in the event of the grant of a patent, utility model or design. Observe copyright by ISO 16016			release date: 20.12.2023
			sheet: 1/1



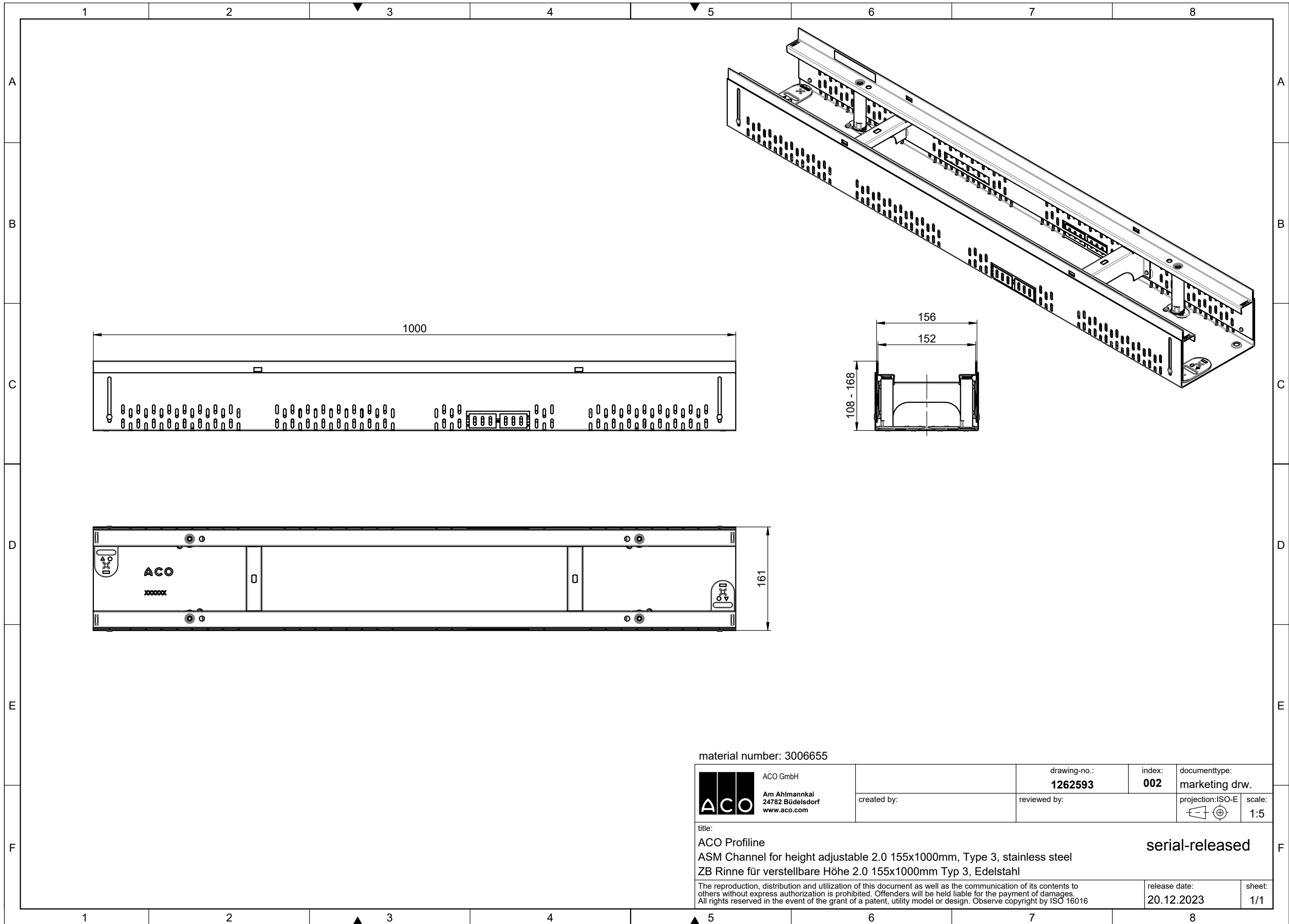

material number: 3006655

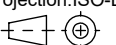
 ACO GmbH Am Ahlmannkai 24782 Büdelsdorf www.aco.com	drawing-no.: <b>1262593</b>	index: <b>002</b>	documenttype: marketing drw.
	created by:	reviewed by:	projection: ISO-E 
title: ACO Profiline ASM Channel for height adjustable 2.0 155x1000mm, Type 3, stainless steel ZB Rinne für verstellbare Höhe 2.0 155x1000mm Typ 3, Edelstahl			serial-released
<small>The reproduction, distribution and utilization of this document as well as the communication of its contents to others without express authorization is prohibited. Offenders will be held liable for the payment of damages. All rights reserved in the event of the grant of a patent, utility model or design. Observe copyright by ISO 16016</small>			release date: 20.12.2023
			sheet: 1/1

S:\projekte\2019\01\ACO\_Vertrieb\22

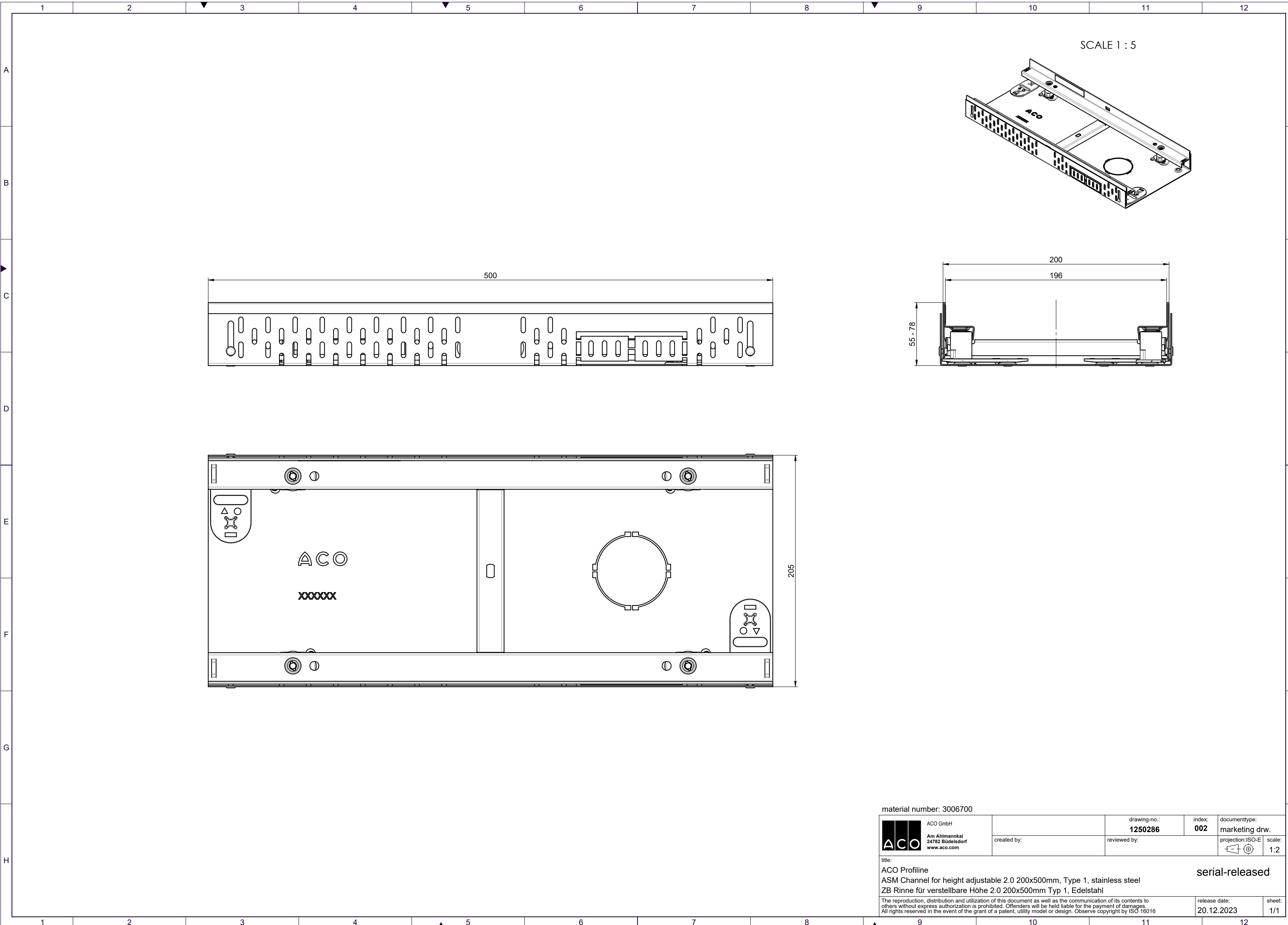

SCALE 1 : 5

500

200

196

55 - 78

205

ACO

XXXXXX

material number: 3006700

 ACO GmbH Am Ahlmannkai 24782 Büdelsdorf www.aco.com	drawing-no.: <b>1250286</b>	index: <b>002</b>	documenttype: marketing drw.
	created by:	reviewed by:	projection: ISO-E scale: 1:2

title:  
 ACO Profiline  
 ASM Channel for height adjustable 2.0 200x500mm, Type 1, stainless steel  
 ZB Rinne für verstellbare Höhe 2.0 200x500mm Typ 1, Edelstahl  
 serial-released

The reproduction, distribution and utilization of this document as well as the communication of its contents to others without express authorization is prohibited. Offenders will be held liable for the payment of damages. All rights reserved in the event of the grant of a patent, utility model or design. Observe copyright by ISO 16016

release date:  
20.12.2023

sheet:  
1/1

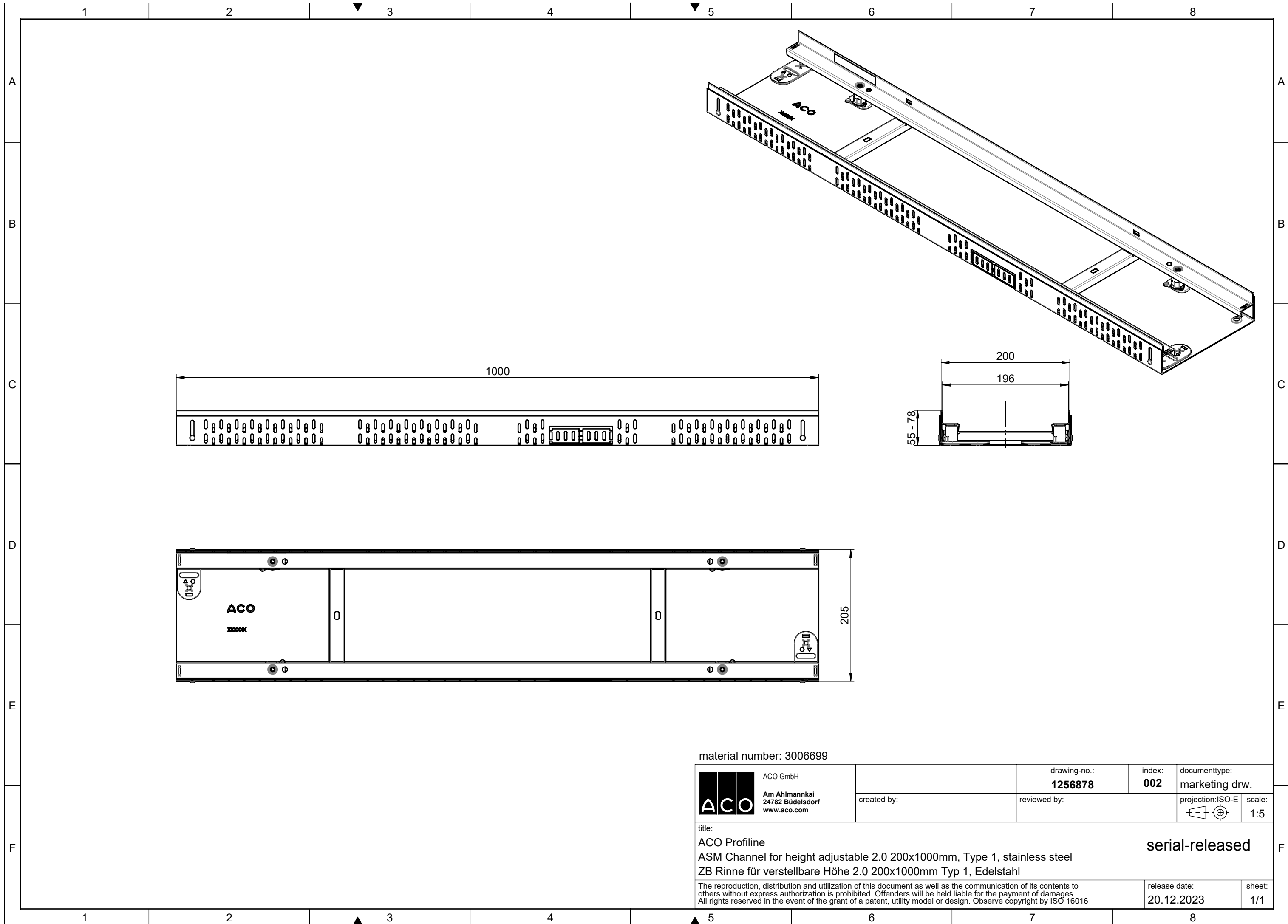

material number: 3006699

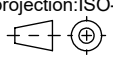
 ACO GmbH Am Ahlmannkai 24782 Büdelsdorf www.aco.com	drawing-no.: <b>1256878</b>	index: <b>002</b>	documenttype: marketing drw.
	created by:	reviewed by:	projection: ISO-E 
title: ACO Profiline ASM Channel for height adjustable 2.0 200x1000mm, Type 1, stainless steel ZB Rinne für verstellbare Höhe 2.0 200x1000mm Typ 1, Edelstahl			serial-released
<small>The reproduction, distribution and utilization of this document as well as the communication of its contents to others without express authorization is prohibited. Offenders will be held liable for the payment of damages. All rights reserved in the event of the grant of a patent, utility model or design. Observe copyright by ISO 16016</small>			release date: 20.12.2023
			sheet: 1/1

S:\projekte\2019\001\_A3\_Versatz\_22

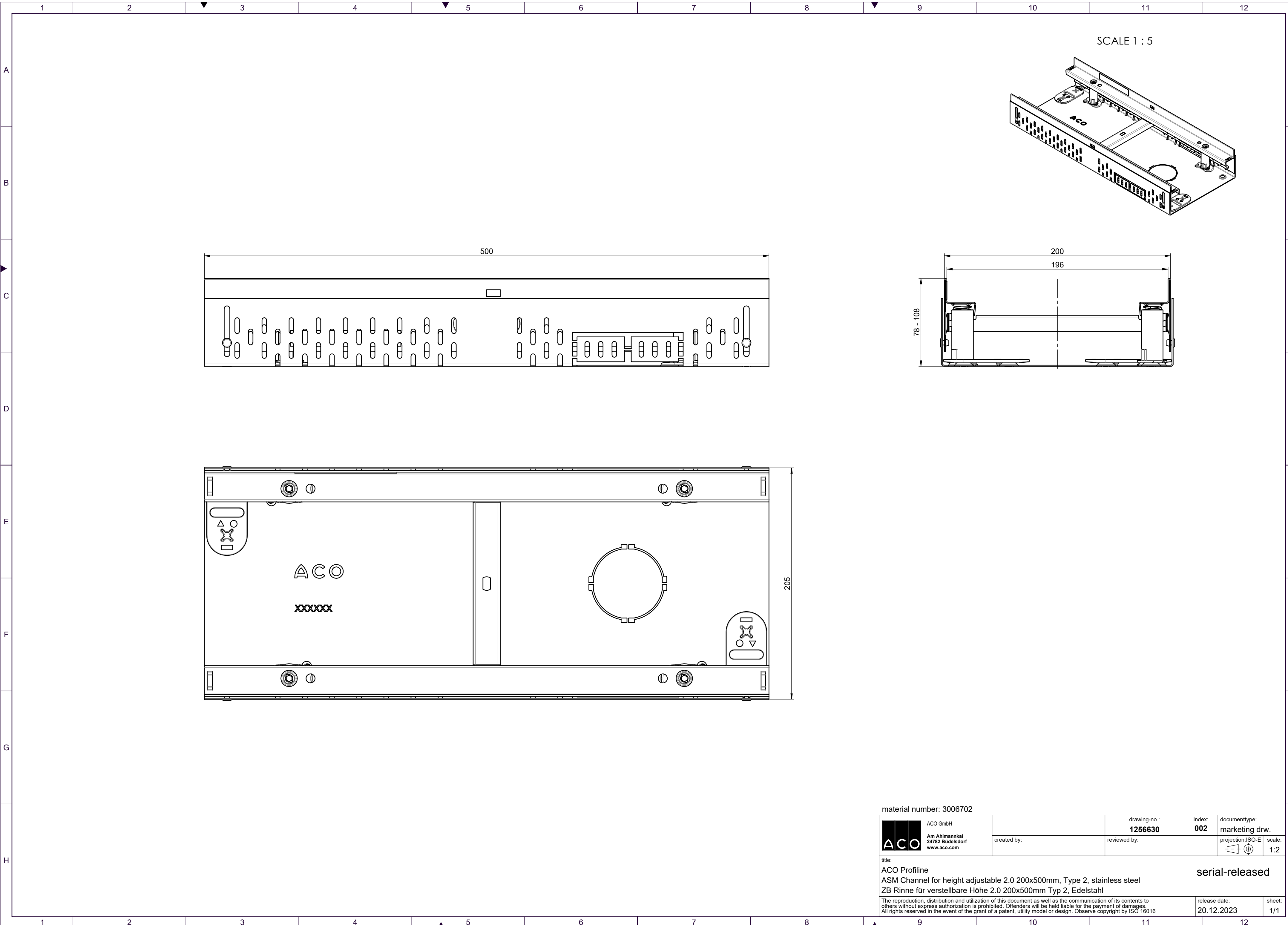

SCALE 1 : 5

500

200  
196  
78 - 108

205

ACO  
XXXXXX

material number: 3006702

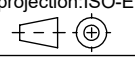
 ACO GmbH Am Ahlmannkai 24782 Büdelsdorf www.aco.com	drawing-no.: <b>1256630</b>	index: <b>002</b>	documenttype: marketing drw.
	created by:	reviewed by:	projection: ISO-E 

title:  
 ACO Profiline  
 ASM Channel for height adjustable 2.0 200x500mm, Type 2, stainless steel  
 ZB Rinne für verstellbare Höhe 2.0 200x500mm Typ 2, Edelstahl

serial-released

The reproduction, distribution and utilization of this document as well as the communication of its contents to others without express authorization is prohibited. Offenders will be held liable for the payment of damages. All rights reserved in the event of the grant of a patent, utility model or design. Observe copyright by ISO 16016

release date:  
 20.12.2023  
 sheet:  
 1/1

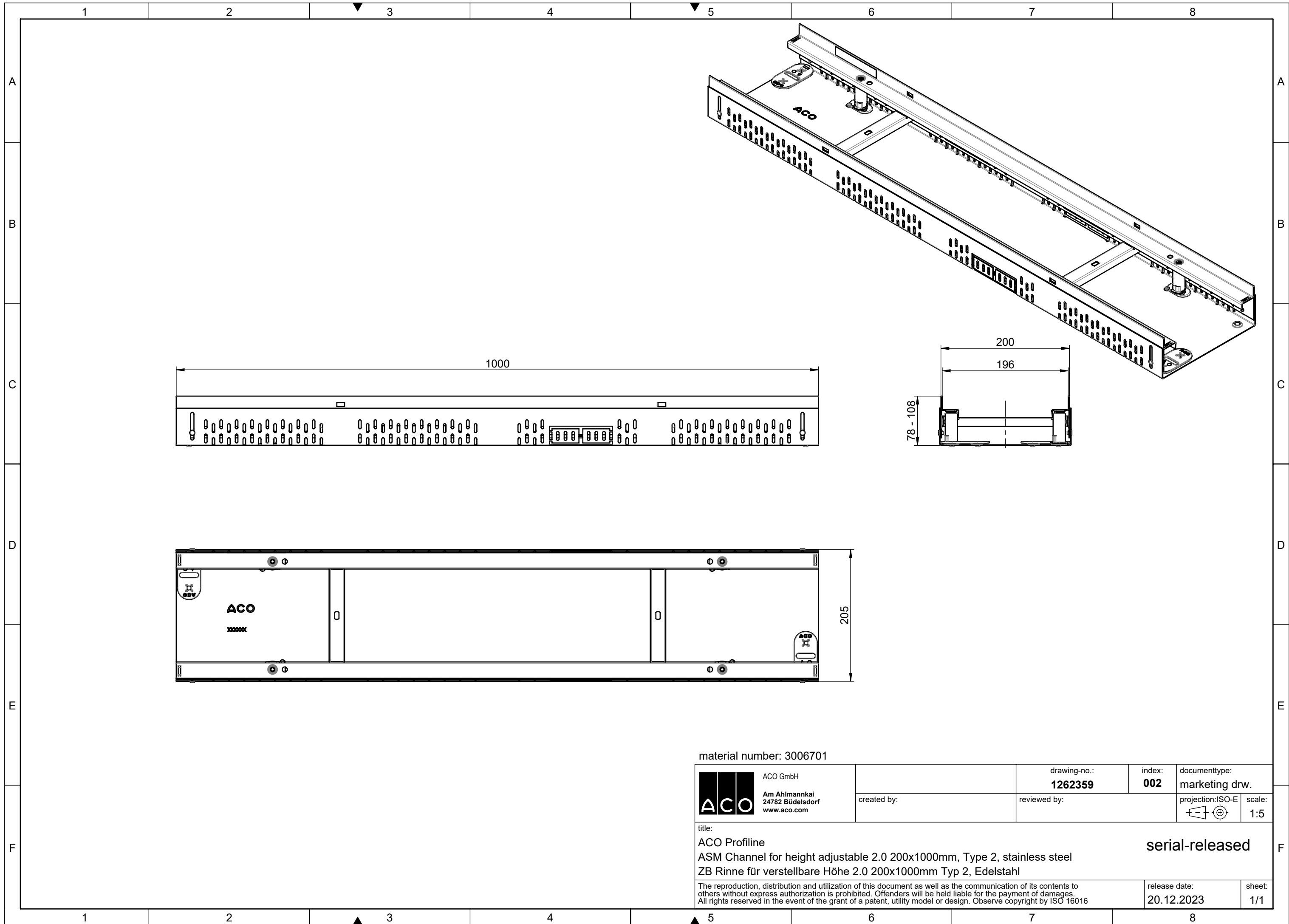

material number: 3006701

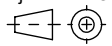
 ACO GmbH Am Ahlmannkai 24782 Büdelsdorf www.aco.com	drawing-no.: <b>1262359</b>	index: <b>002</b>	documenttype: marketing drw.
	created by:	reviewed by:	projection: ISO-E 
title: ACO Profiline ASM Channel for height adjustable 2.0 200x1000mm, Type 2, stainless steel ZB Rinne für verstellbare Höhe 2.0 200x1000mm Typ 2, Edelstahl			serial-released
<small>The reproduction, distribution and utilization of this document as well as the communication of its contents to others without express authorization is prohibited. Offenders will be held liable for the payment of damages. All rights reserved in the event of the grant of a patent, utility model or design. Observe copyright by ISO 16016</small>			release date: 20.12.2023
			sheet: 1/1

S:\060000\2019-001\3-Verkost.22

1 2 3 4 5 6 7 8 9 10 11 12

A

B

C

D

E

F

G

H

SCALE 1 : 5

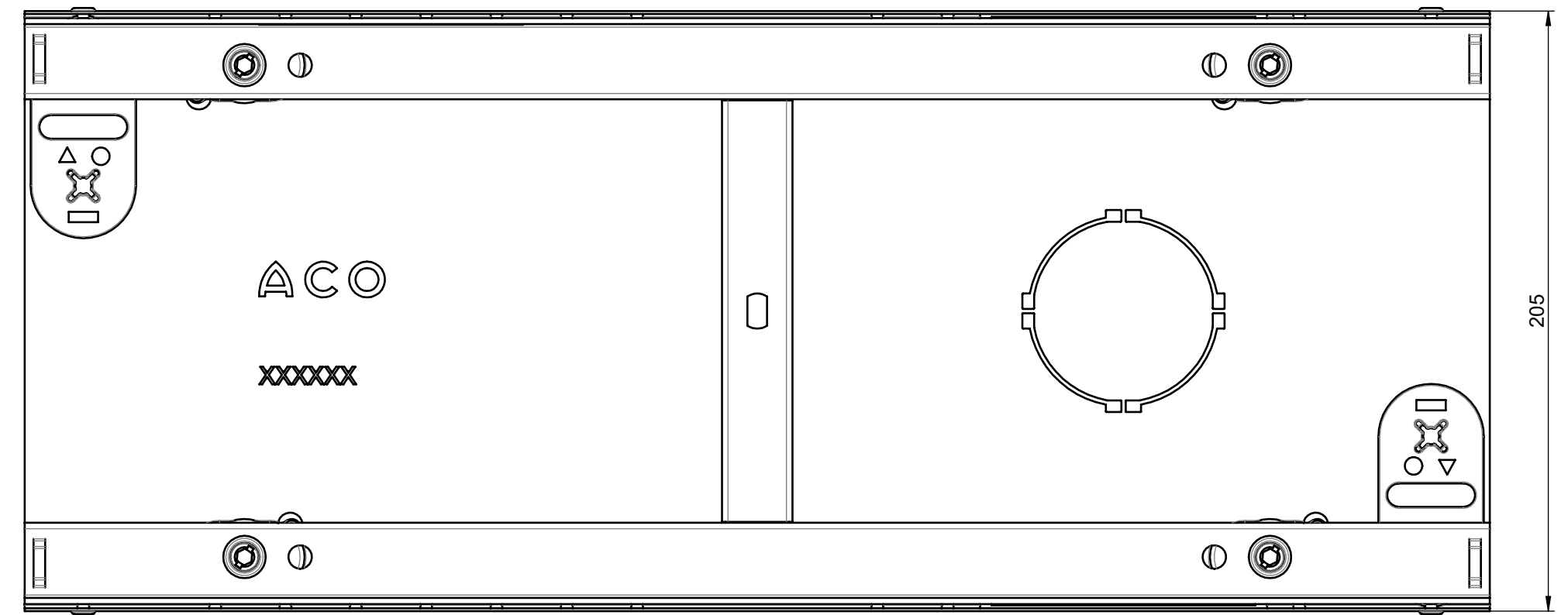
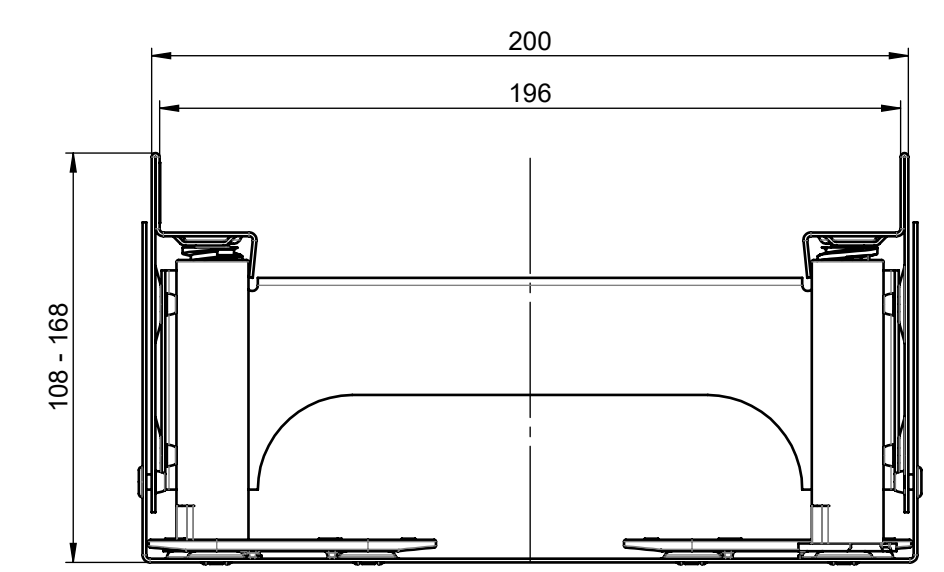
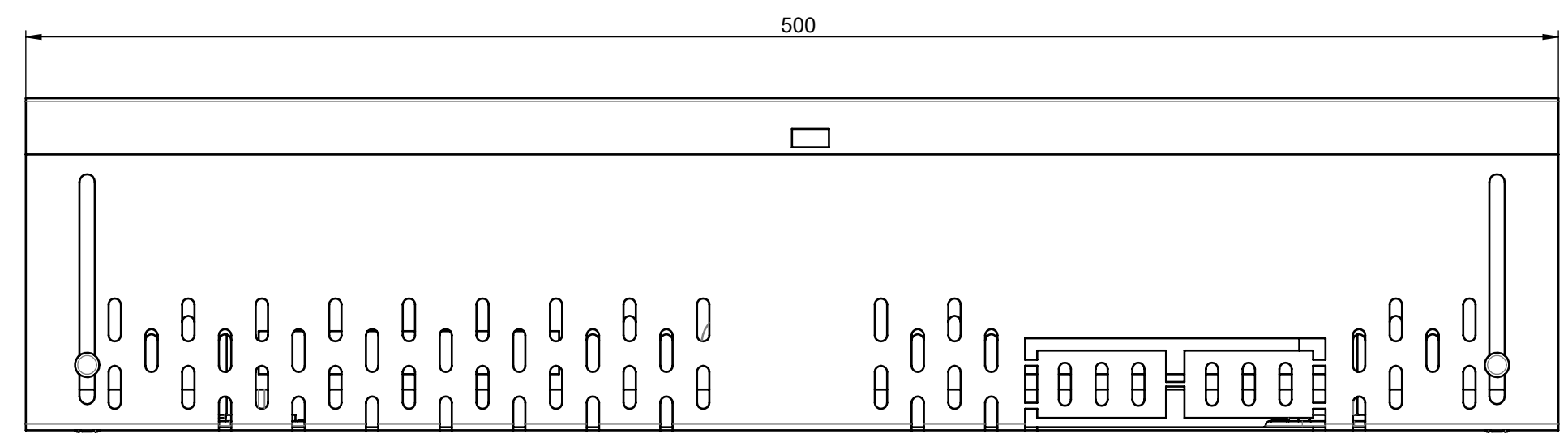
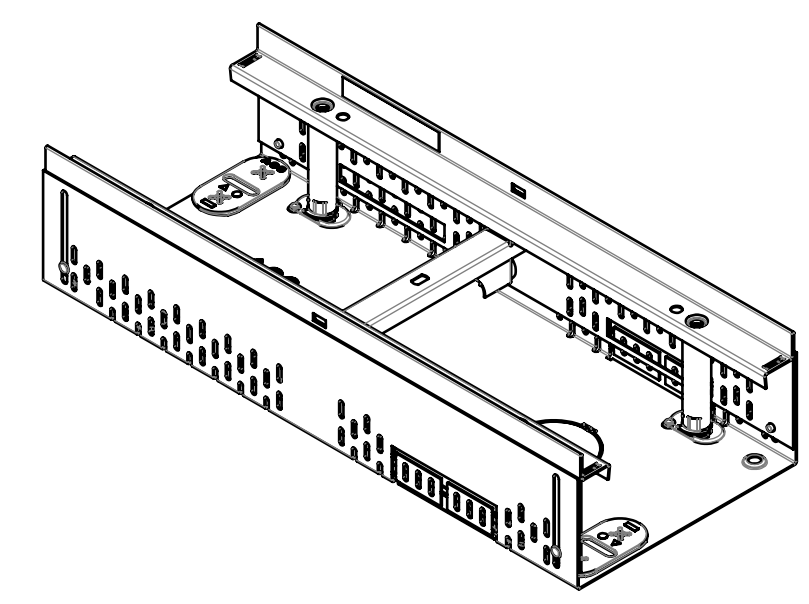

material number: 3006704

 ACO GmbH Am Ahlmannkai 24782 Büdelsdorf www.aco.com	drawing-no.: <b>1257580</b>	index: <b>002</b>	documenttype: marketing drw.
	created by:	reviewed by:	projection: ISO-E scale: 1:2

title:  
**ACO Profiline**  
 ASM Channel for height adjustable 2.0 200x500mm, Type 3, stainless steel  
 ZB Rinne für verstellbare Höhe 2.0 200x500mm Typ 3, Edelstahl

serial-released

The reproduction, distribution and utilization of this document as well as the communication of its contents to others without express authorization is prohibited. Offenders will be held liable for the payment of damages. All rights reserved in the event of the grant of a patent, utility model or design. Observe copyright by ISO 16016

release date:  
20.12.2023

sheet:  
1/1

1 2 3 4 5 6 7 8 9 10 11 12

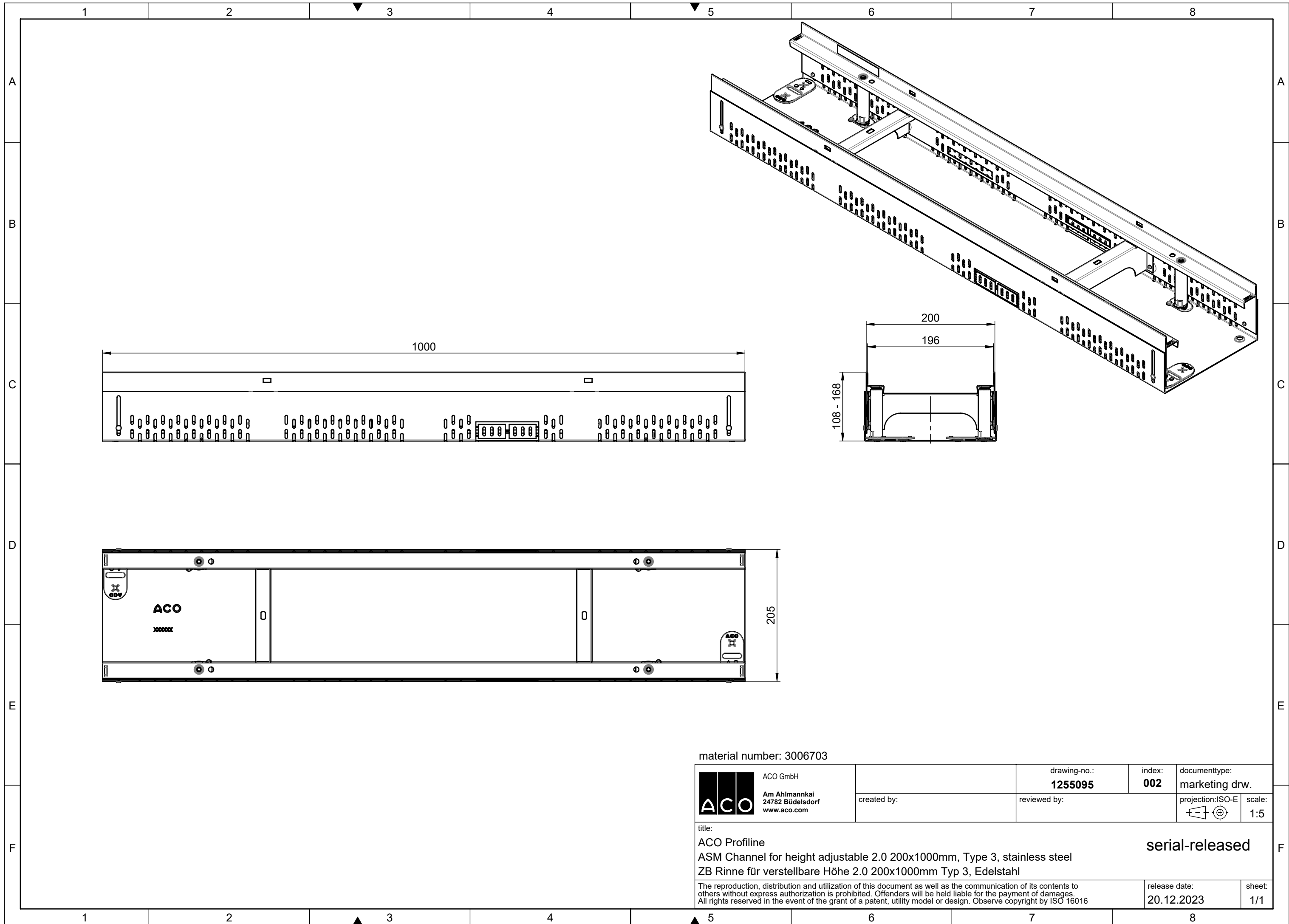

material number: 3006703

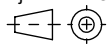
 ACO GmbH Am Ahlmannkai 24782 Büdelsdorf www.aco.com	drawing-no.: <b>1255095</b>	index: <b>002</b>	documenttype: marketing drw.
	created by:	reviewed by:	projection: ISO-E 
title: ACO Profiline ASM Channel for height adjustable 2.0 200x1000mm, Type 3, stainless steel ZB Rinne für verstellbare Höhe 2.0 200x1000mm Typ 3, Edelstahl			serial-released
<small>The reproduction, distribution and utilization of this document as well as the communication of its contents to others without express authorization is prohibited. Offenders will be held liable for the payment of damages. All rights reserved in the event of the grant of a patent, utility model or design. Observe copyright by ISO 16016</small>			release date: 20.12.2023
			sheet: 1/1

S:\projekte\2019\001\_A3\_Vertrieb\22

1 2 3 4 5 6 7 8 9 10 11 12

A B C D E F G H

SCALE 1 : 5

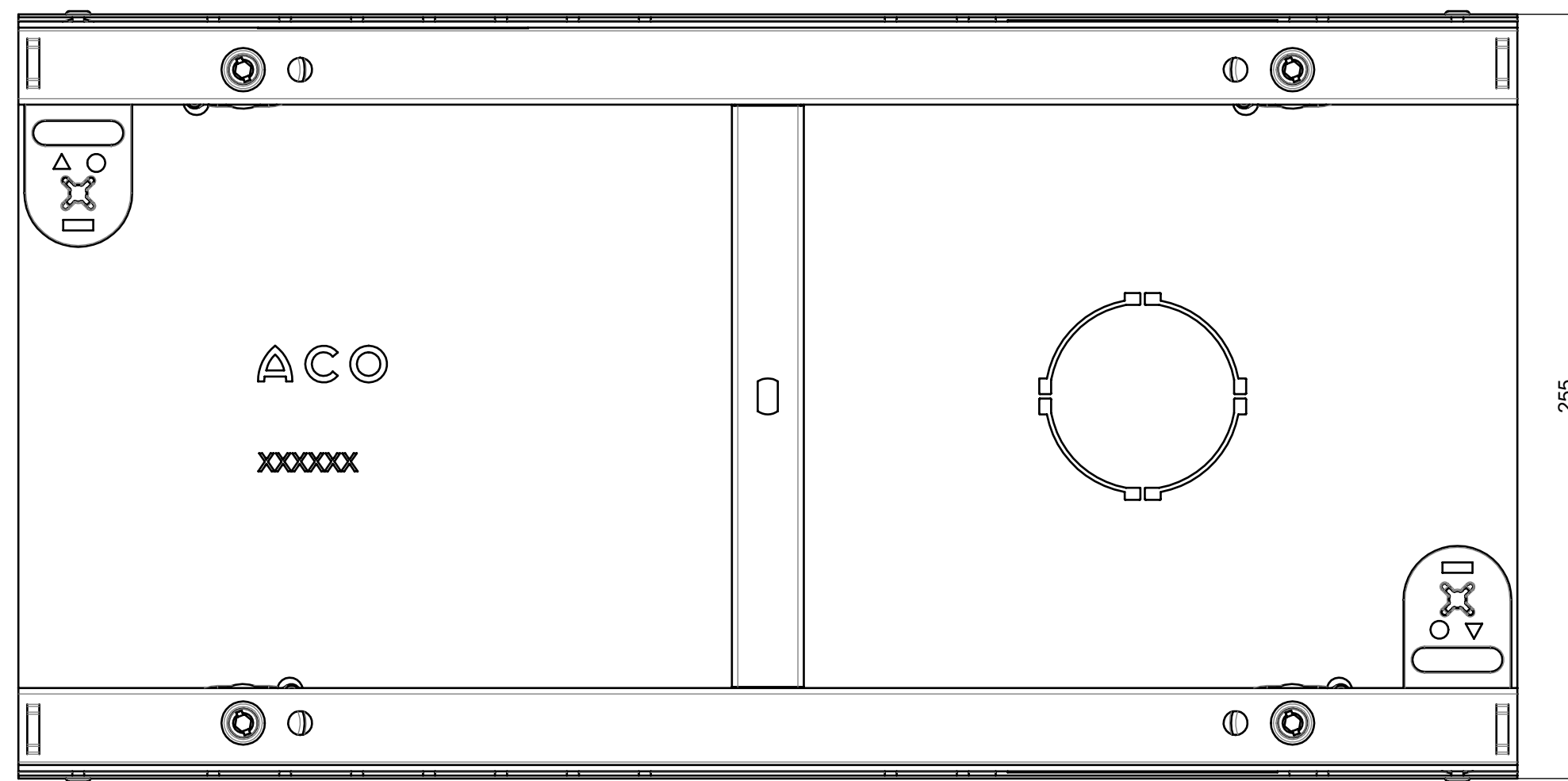
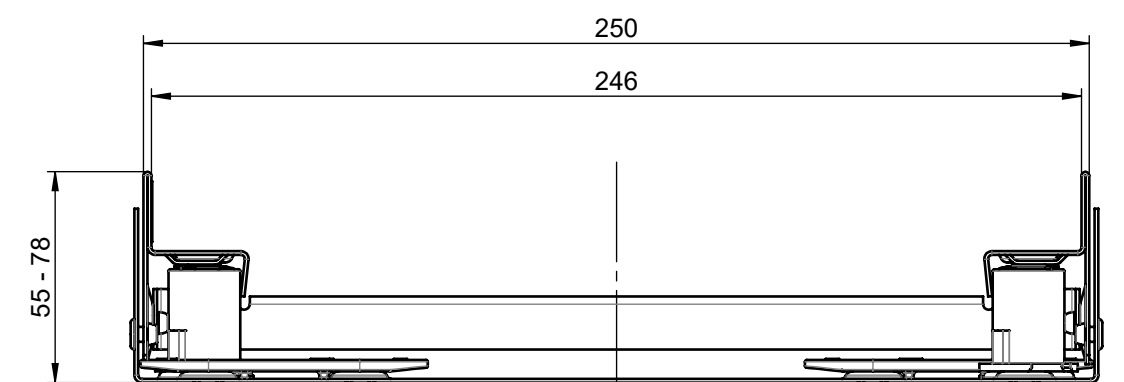
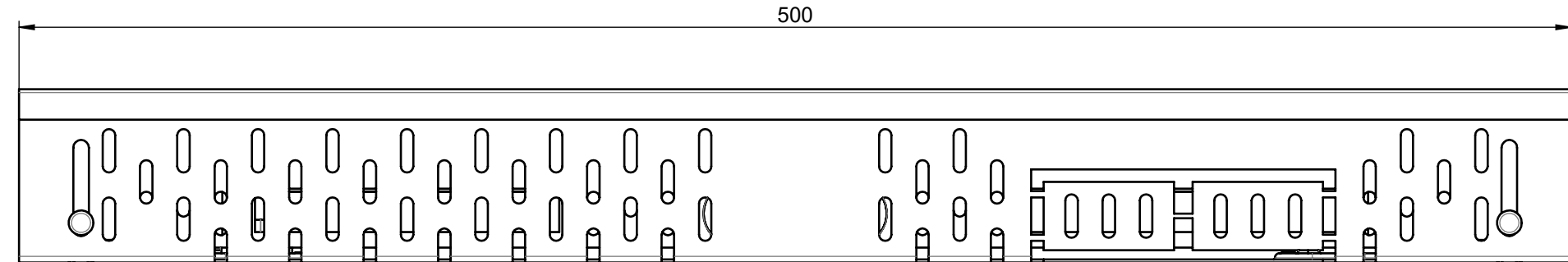
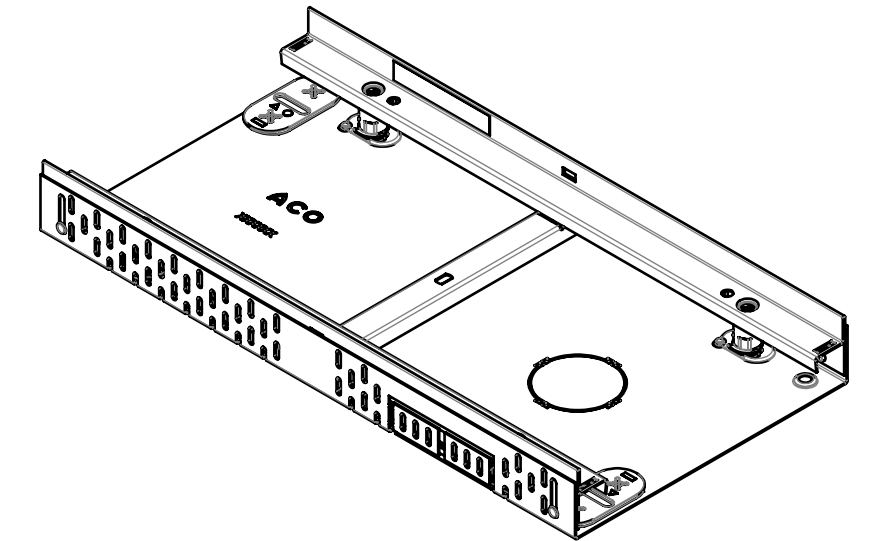

material number: 3006668

 ACO GmbH Am Ahlmannkai 24782 Büdelsdorf www.aco.com	drawing-no.: <b>1260503</b>	index: <b>002</b>	documenttype: marketing drw.
	created by:	reviewed by:	projection: ISO-E scale: 1:2

title:  
**ACO Profiline**  
 ASM Channel for height adjustable 2.0 250x500mm, Type 1, stainless steel  
 ZB Rinne für verstellbare Höhe 2.0 250x500mm Typ 1, Edelstahl

**serial-released**

The reproduction, distribution and utilization of this document as well as the communication of its contents to others without express authorization is prohibited. Offenders will be held liable for the payment of damages. All rights reserved in the event of the grant of a patent, utility model or design. Observe copyright by ISO 16016

release date: **20.12.2023** sheet: **1/1**

1 2 3 4 5 6 7 8 9 10 11 12



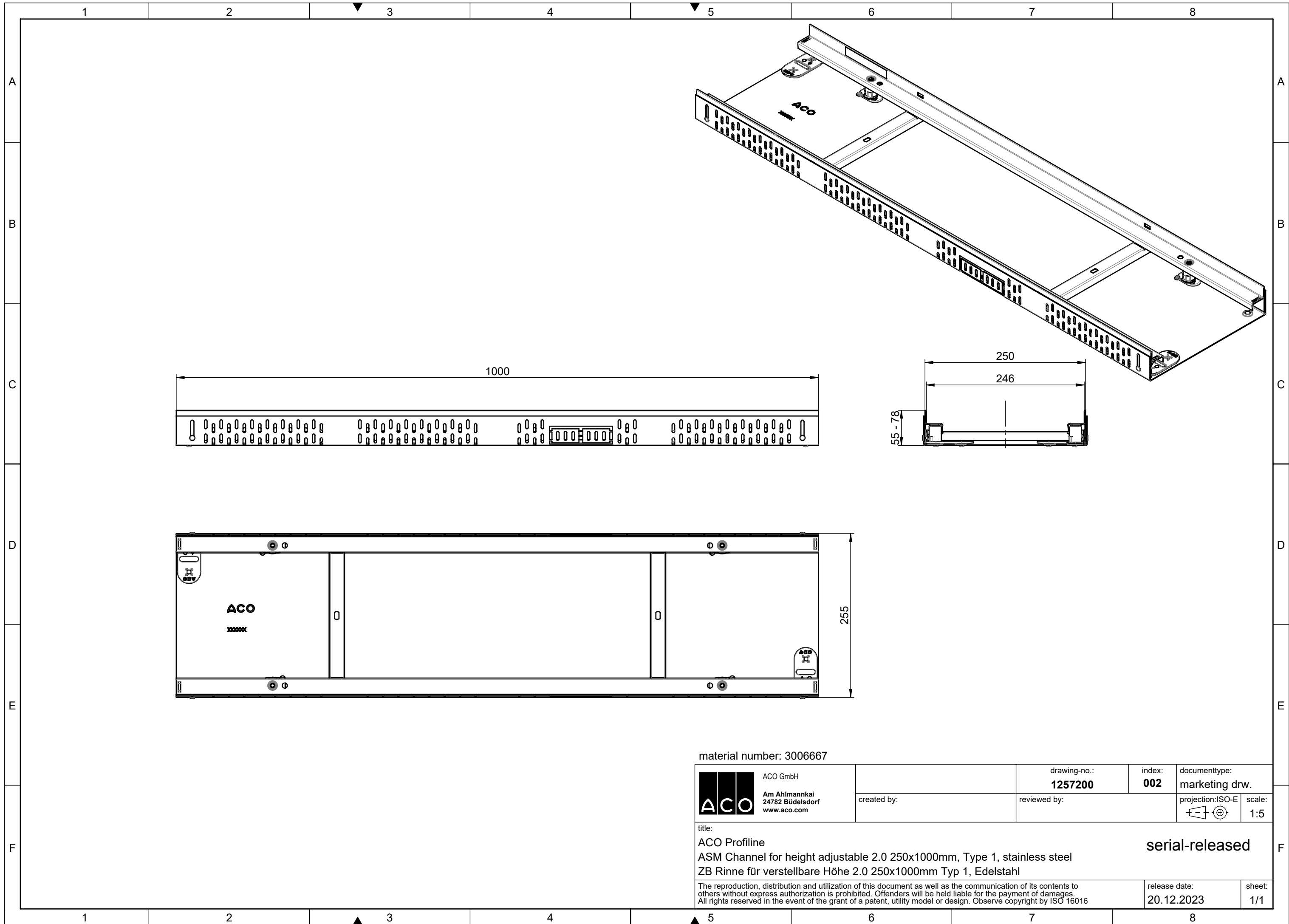

material number: 3006667

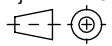
 ACO GmbH Am Ahlmannkai 24782 Büdelsdorf www.aco.com	drawing-no.: <b>1257200</b>	index: <b>002</b>	documenttype: marketing drw.
	created by:	reviewed by:	projection: ISO-E  scale: 1:5
title: ACO Profiline ASM Channel for height adjustable 2.0 250x1000mm, Type 1, stainless steel ZB Rinne für verstellbare Höhe 2.0 250x1000mm Typ 1, Edelstahl			serial-released
The reproduction, distribution and utilization of this document as well as the communication of its contents to others without express authorization is prohibited. Offenders will be held liable for the payment of damages. All rights reserved in the event of the grant of a patent, utility model or design. Observe copyright by ISO 16016			release date: 20.12.2023
			sheet: 1/1

1 2 3 4 5 6 7 8 9 10 11 12

A  
B  
C  
D  
E  
F  
G  
H

SCALE 1 : 5

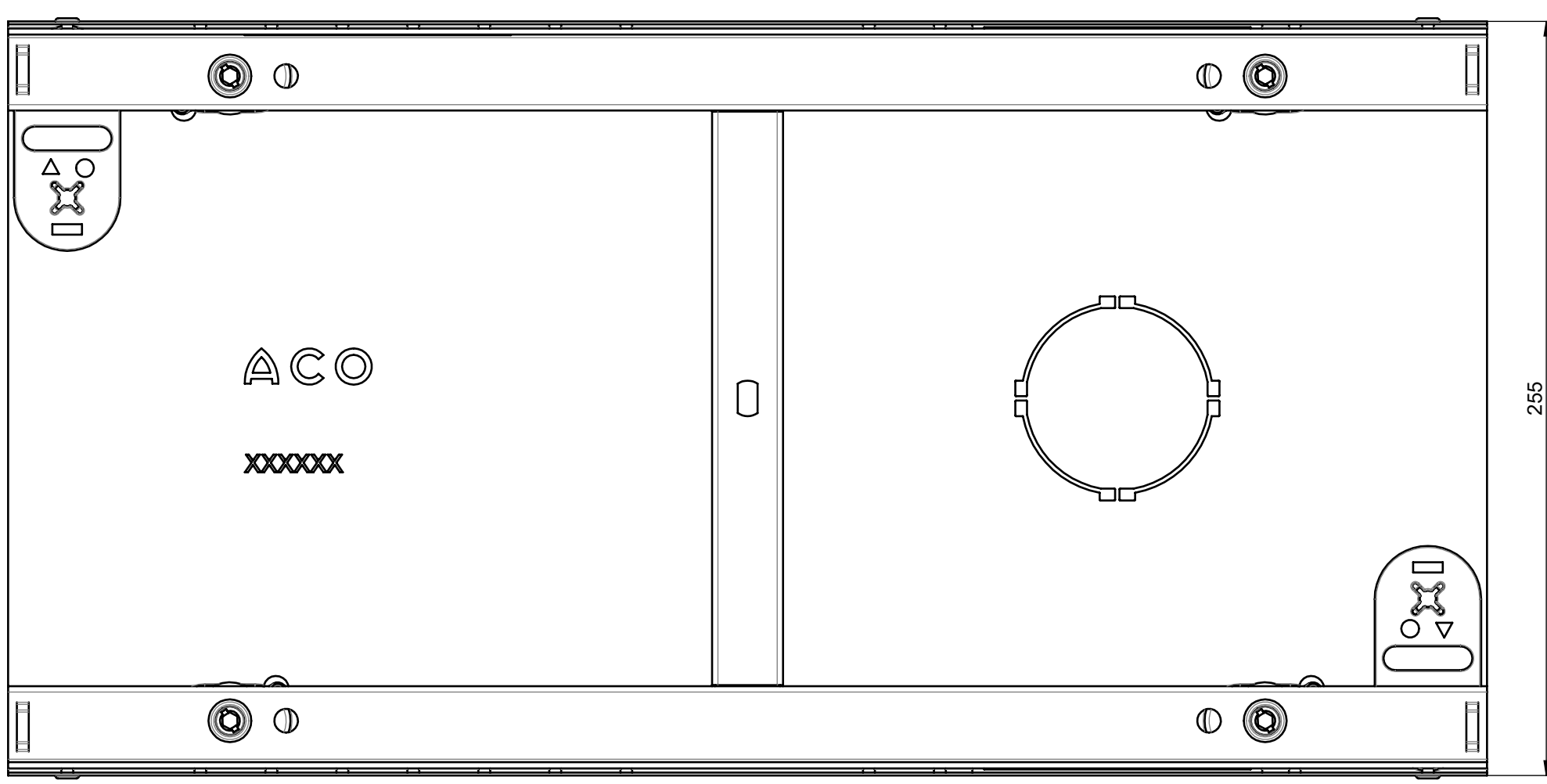
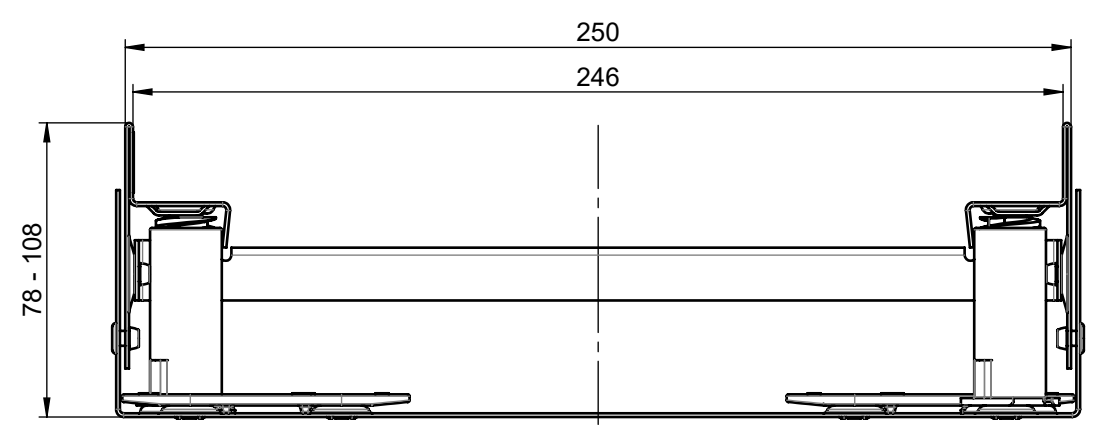
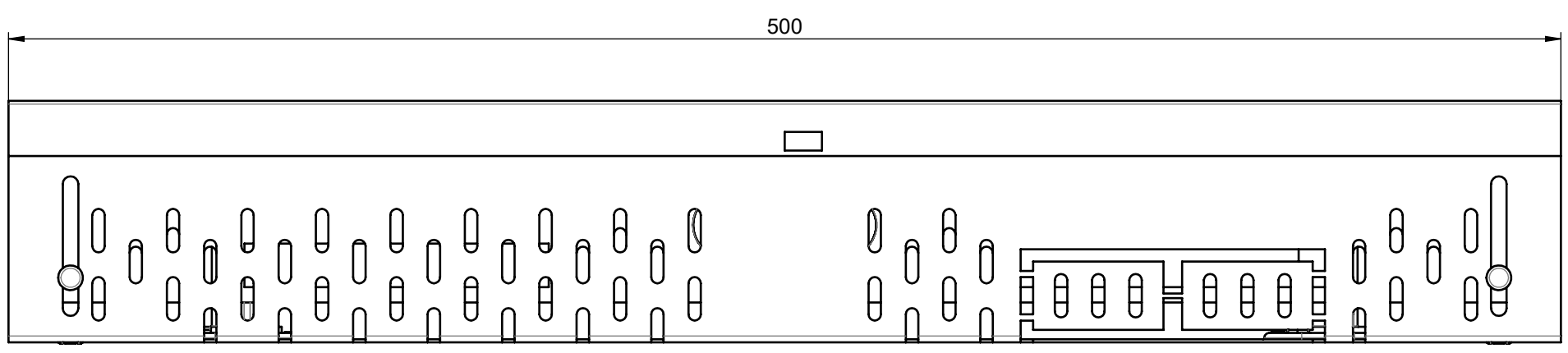
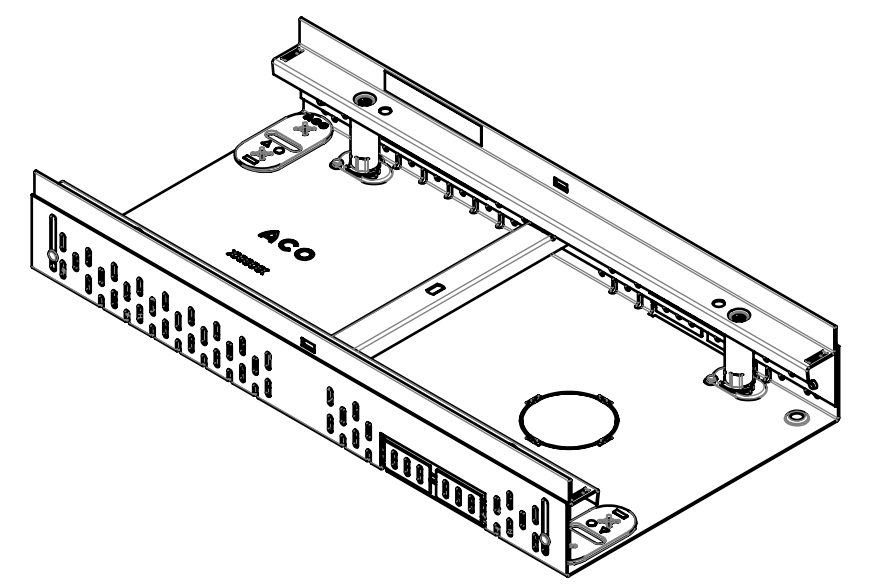

material number: 3006672

 ACO GmbH Am Ahlmannkai 24782 Büdelsdorf www.aco.com	drawing-no.: <b>1252374</b>	index: <b>002</b>	documenttype: marketing drw.
	created by:	reviewed by:	projection: ISO-E scale: 1:2

title:  
**ACO Profiline**  
 ASM Channel for height adjustable 2.0 250x500mm, Type 2, stainless steel  
 ZB Rinne für verstellbare Höhe 2.0 250x500mm Typ 2, Edelstahl

serial-released

The reproduction, distribution and utilization of this document as well as the communication of its contents to others without express authorization is prohibited. Offenders will be held liable for the payment of damages. All rights reserved in the event of the grant of a patent, utility model or design. Observe copyright by ISO 16016

release date:  
20.12.2023

sheet:  
1/1

1 2 3 4 5 6 7 8 9 10 11 12

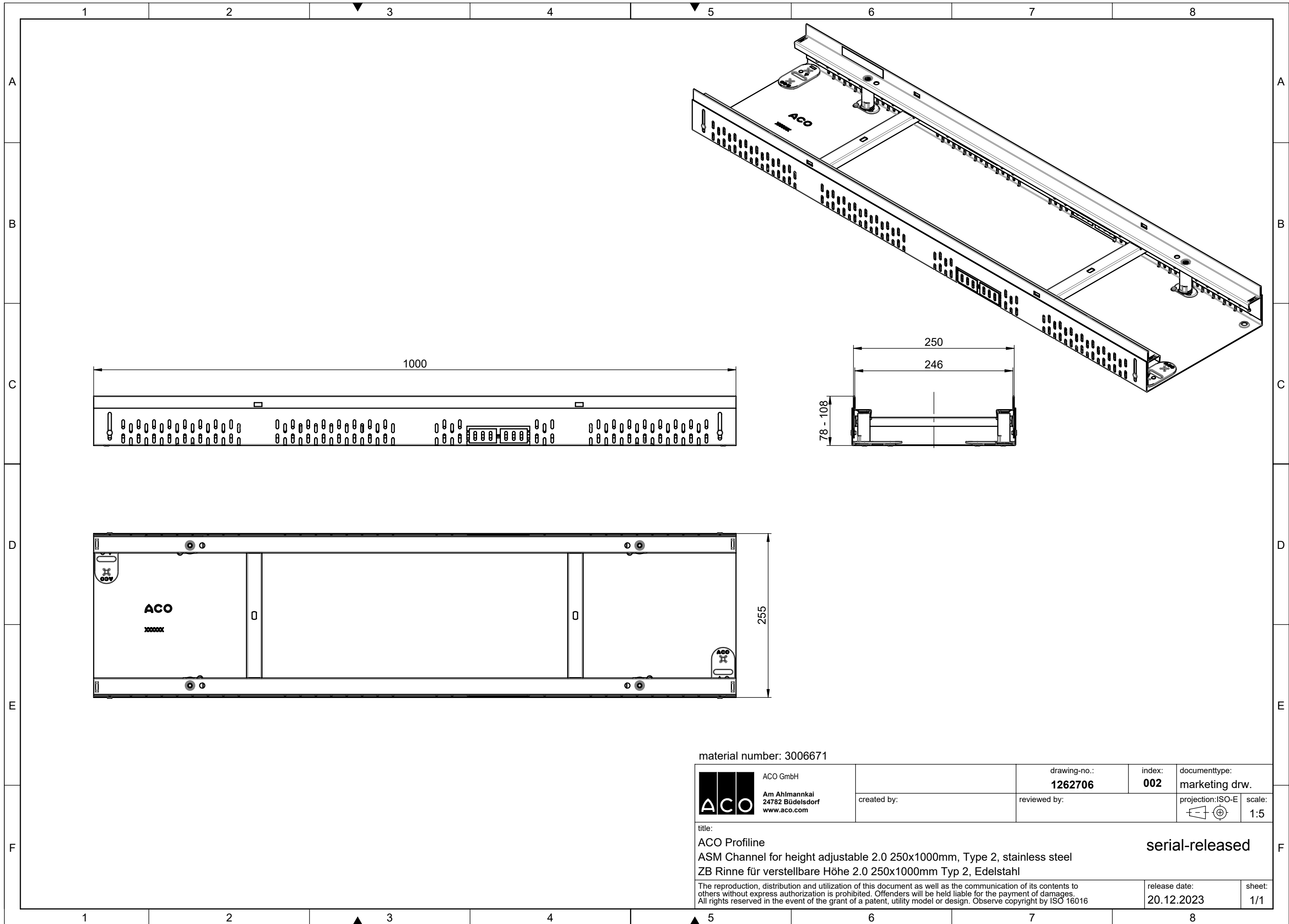

material number: 3006671

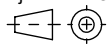
 ACO GmbH Am Ahlmannkai 24782 Büdelsdorf www.aco.com	drawing-no.: <b>1262706</b>	index: <b>002</b>	documenttype: marketing drw.
	created by:	reviewed by:	projection: ISO-E  scale: 1:5
title: ACO Proflin ASM Channel for height adjustable 2.0 250x1000mm, Type 2, stainless steel ZB Rinne für verstellbare Höhe 2.0 250x1000mm Typ 2, Edelstahl			serial-released
The reproduction, distribution and utilization of this document as well as the communication of its contents to others without express authorization is prohibited. Offenders will be held liable for the payment of damages. All rights reserved in the event of the grant of a patent, utility model or design. Observe copyright by ISO 16016			release date: 20.12.2023
			sheet: 1/1

1 2 3 4 5 6 7 8 9 10 11 12

A

B

C

D

E

F

G

H

SCALE 1 : 5

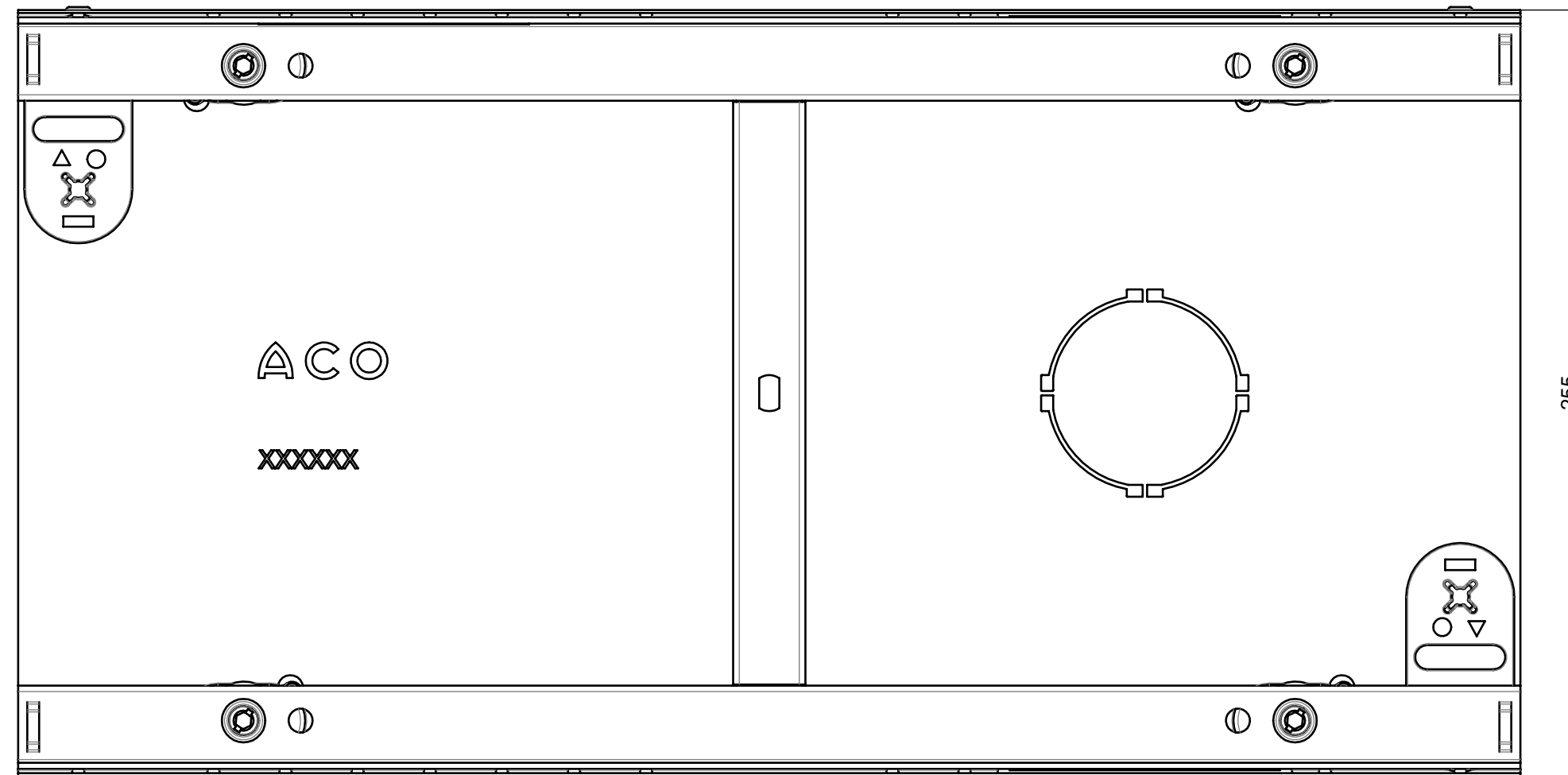
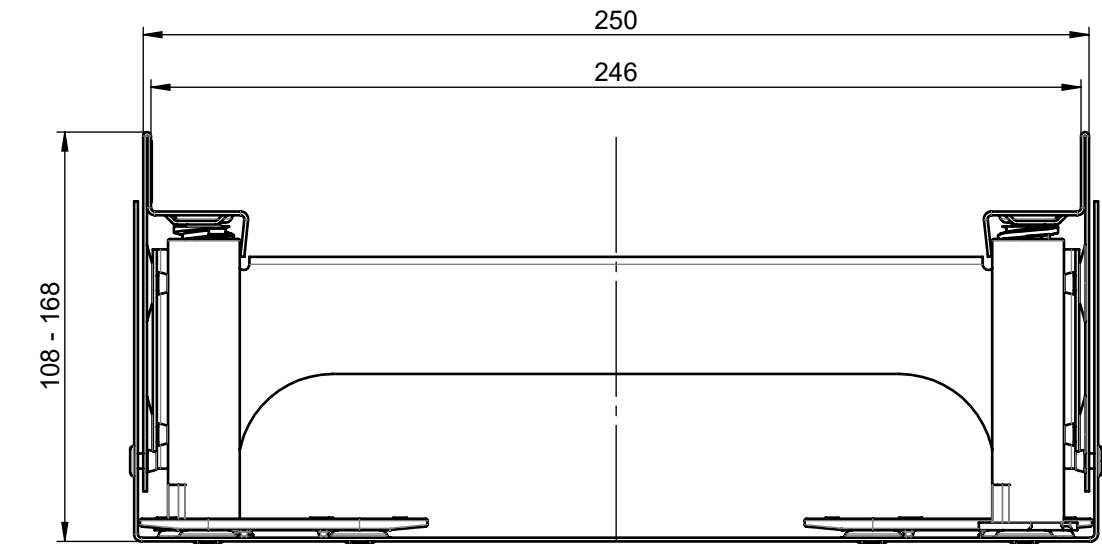
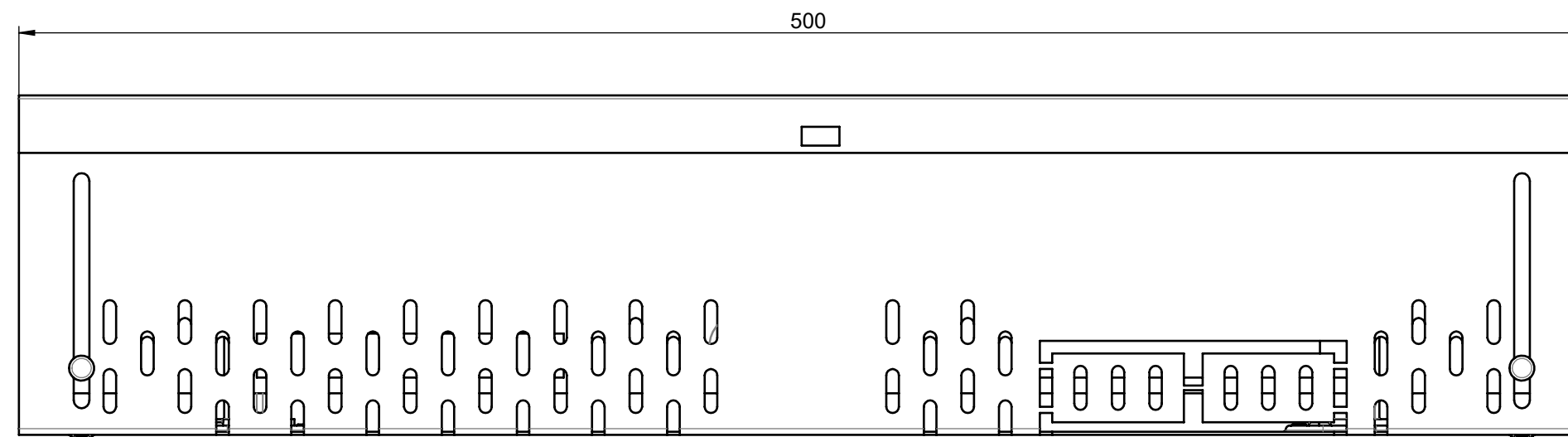
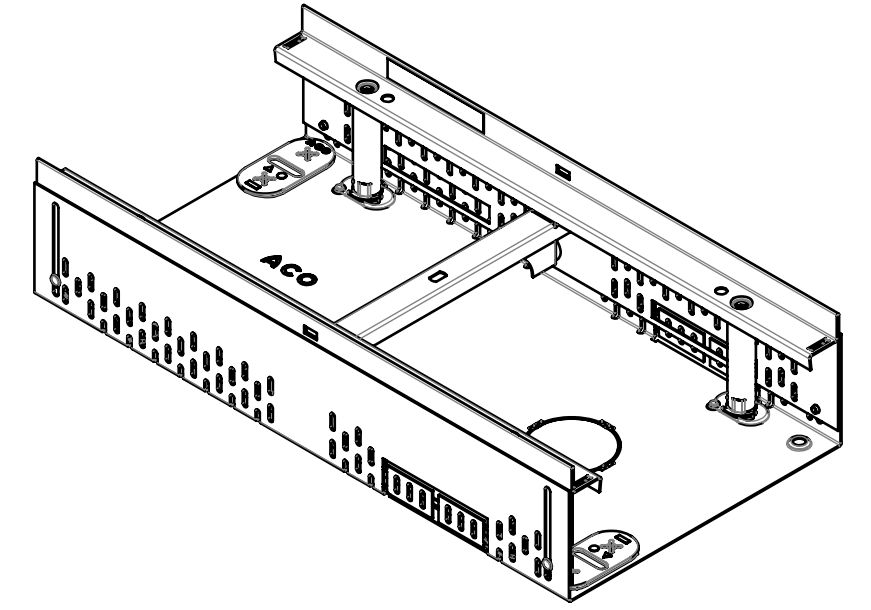

material number: 3006676

 ACO GmbH Am Ahlmannkai 24782 Büdelsdorf www.aco.com	drawing-no.: <b>1257170</b>	index: <b>002</b>	documenttype: marketing drw.
	created by:	reviewed by:	projection: ISO-E scale: 1:2

title:  
**ACO Profiline**  
 ASM Channel for height adjustable 2.0 250x500mm, Type 3, stainless steel  
 ZB Rinne für verstellbare Höhe 2.0 250x500mm Typ 3, Edelstahl

serial-released

The reproduction, distribution and utilization of this document as well as the communication of its contents to others without express authorization is prohibited. Offenders will be held liable for the payment of damages. All rights reserved in the event of the grant of a patent, utility model or design. Observe copyright by ISO 16016

release date: 20.12.2023	sheet: 1/1
-----------------------------	---------------

1 2 3 4 5 6 7 8 9 10 11 12

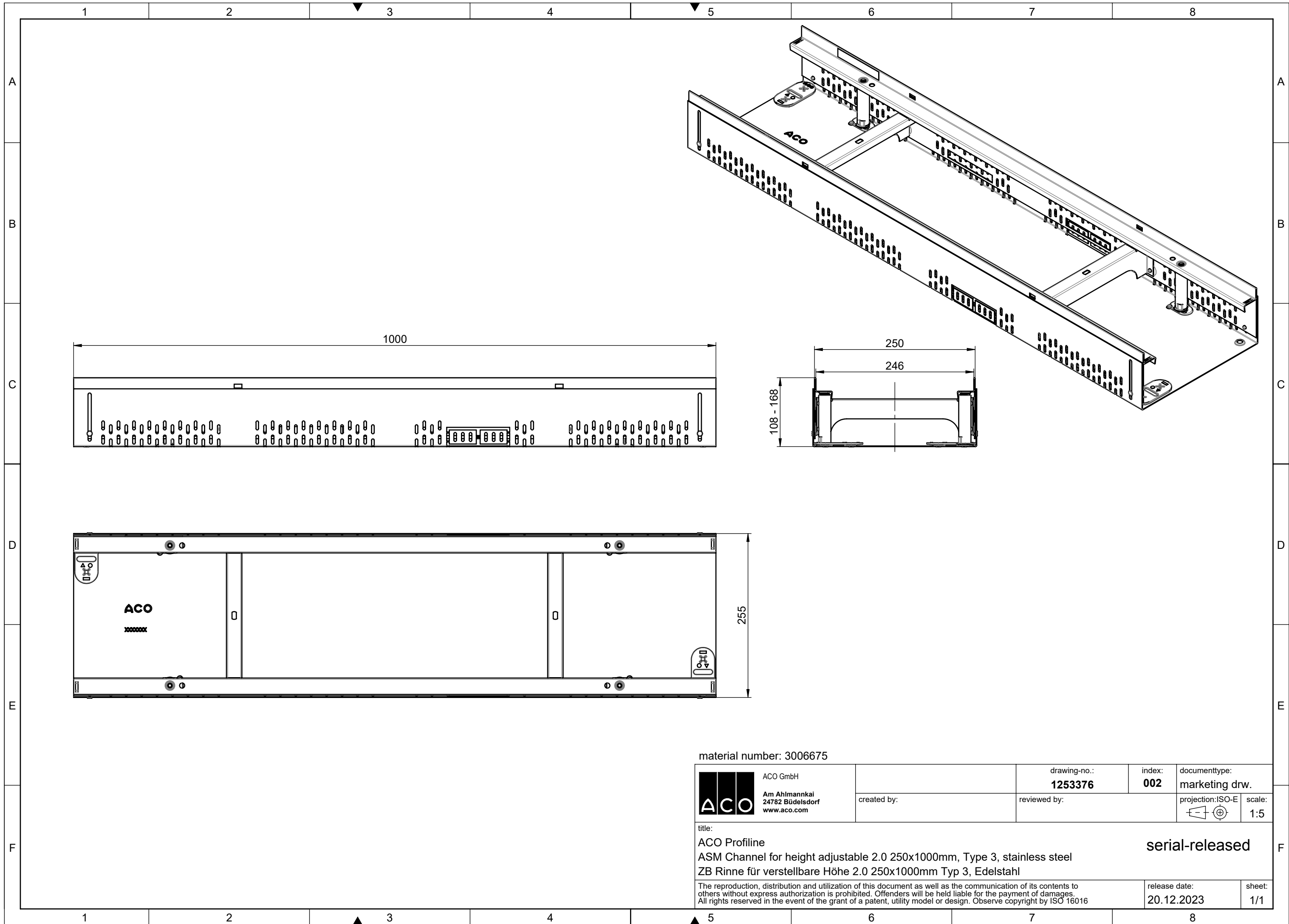

material number: 3006675

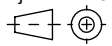
 ACO GmbH Am Ahlmannkai 24782 Büdelsdorf www.aco.com	drawing-no.: <b>1253376</b>	index: <b>002</b>	documenttype: marketing drw.
	created by:	reviewed by:	projection: ISO-E 
title: ACO Proflin ASM Channel for height adjustable 2.0 250x1000mm, Type 3, stainless steel ZB Rinne für verstellbare Höhe 2.0 250x1000mm Typ 3, Edelstahl			serial-released
<small>The reproduction, distribution and utilization of this document as well as the communication of its contents to others without express authorization is prohibited. Offenders will be held liable for the payment of damages. All rights reserved in the event of the grant of a patent, utility model or design. Observe copyright by ISO 16016</small>			release date: 20.12.2023
			sheet: 1/1

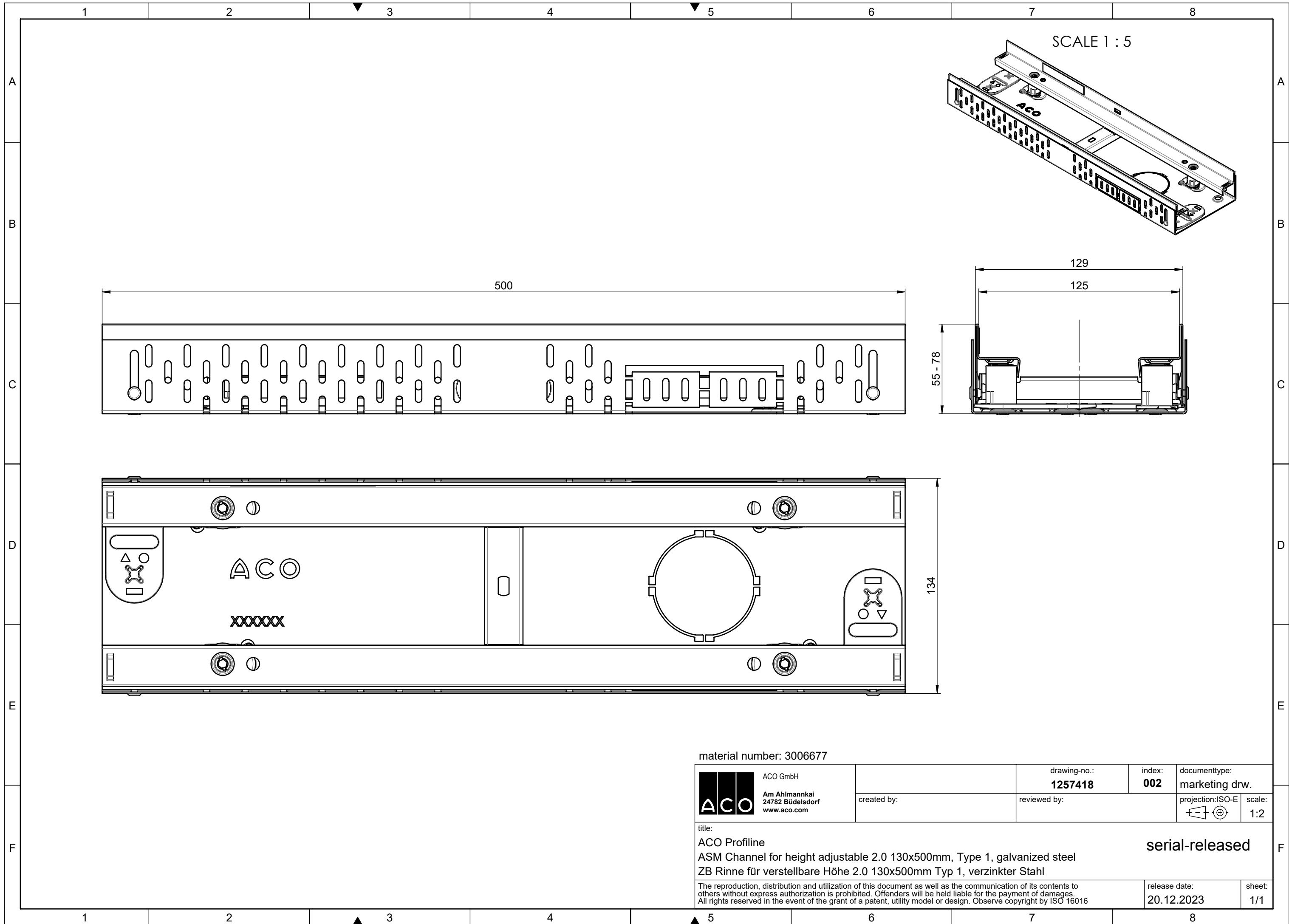

material number: 3006677

 ACO GmbH Am Ahlmannkai 24782 Büdelsdorf www.aco.com	created by:	drawing-no.: <b>1257418</b>	index: <b>002</b>	documenttype: marketing drw.
	reviewed by:	projection: ISO-E	scale: 1:2	
title: ACO Proffline ASM Channel for height adjustable 2.0 130x500mm, Type 1, galvanized steel ZB Rinne für verstellbare Höhe 2.0 130x500mm Typ 1, verzinkter Stahl				serial-released
The reproduction, distribution and utilization of this document as well as the communication of its contents to others without express authorization is prohibited. Offenders will be held liable for the payment of damages. All rights reserved in the event of the grant of a patent, utility model or design. Observe copyright by ISO 16016			release date: 20.12.2023	sheet: 1/1

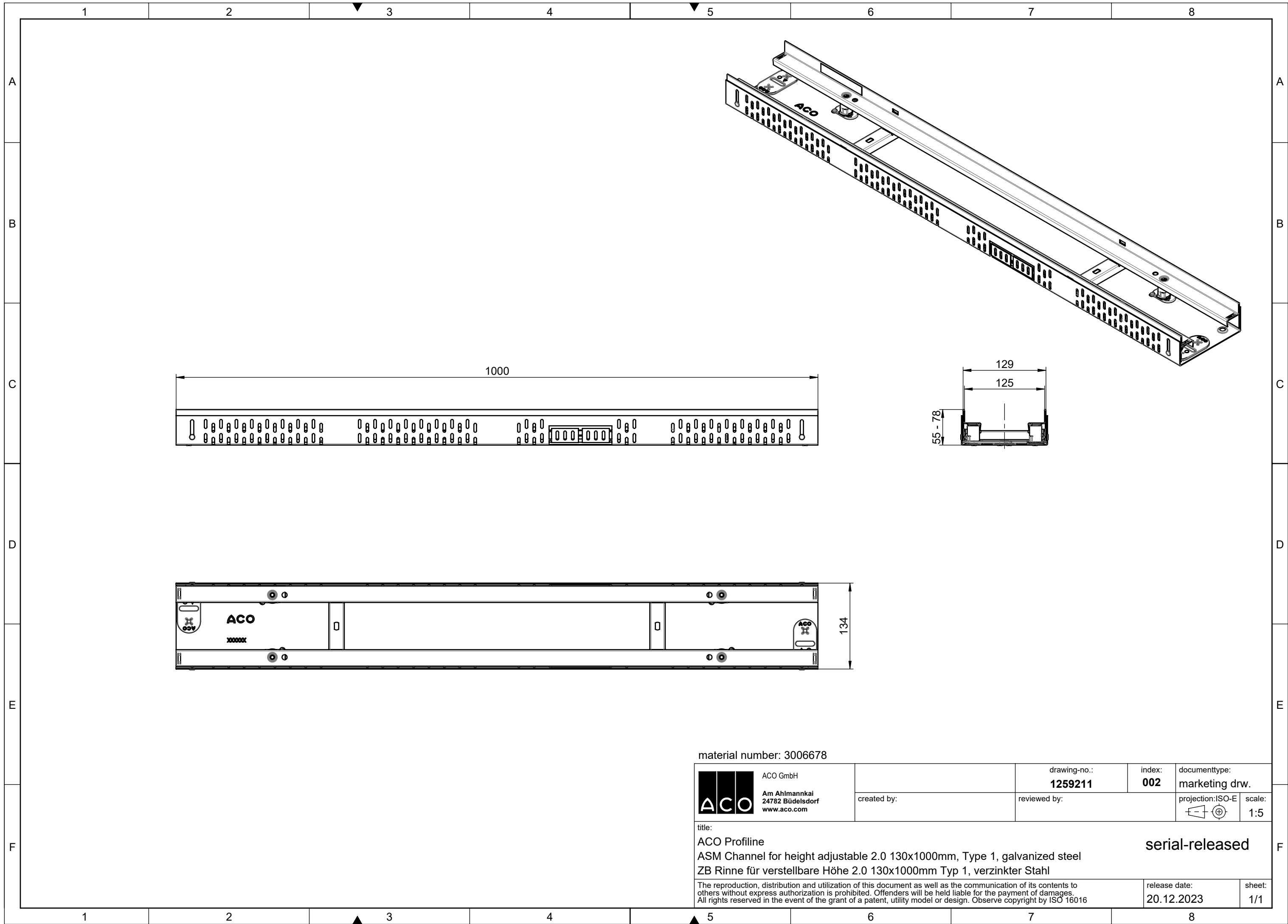

material number: 3006678

 ACO GmbH Am Ahlmannkai 24782 Büdelsdorf www.aco.com	drawing-no.: <b>1259211</b>	index: <b>002</b>	documenttype: marketing drw.
	created by:	reviewed by:	projection: ISO-E 
title: ACO Profiline ASM Channel for height adjustable 2.0 130x1000mm, Type 1, galvanized steel ZB Rinne für verstellbare Höhe 2.0 130x1000mm Typ 1, verzinkter Stahl			serial-released
<small>The reproduction, distribution and utilization of this document as well as the communication of its contents to others without express authorization is prohibited. Offenders will be held liable for the payment of damages. All rights reserved in the event of the grant of a patent, utility model or design. Observe copyright by ISO 16016</small>			release date: 20.12.2023
			sheet: 1/1

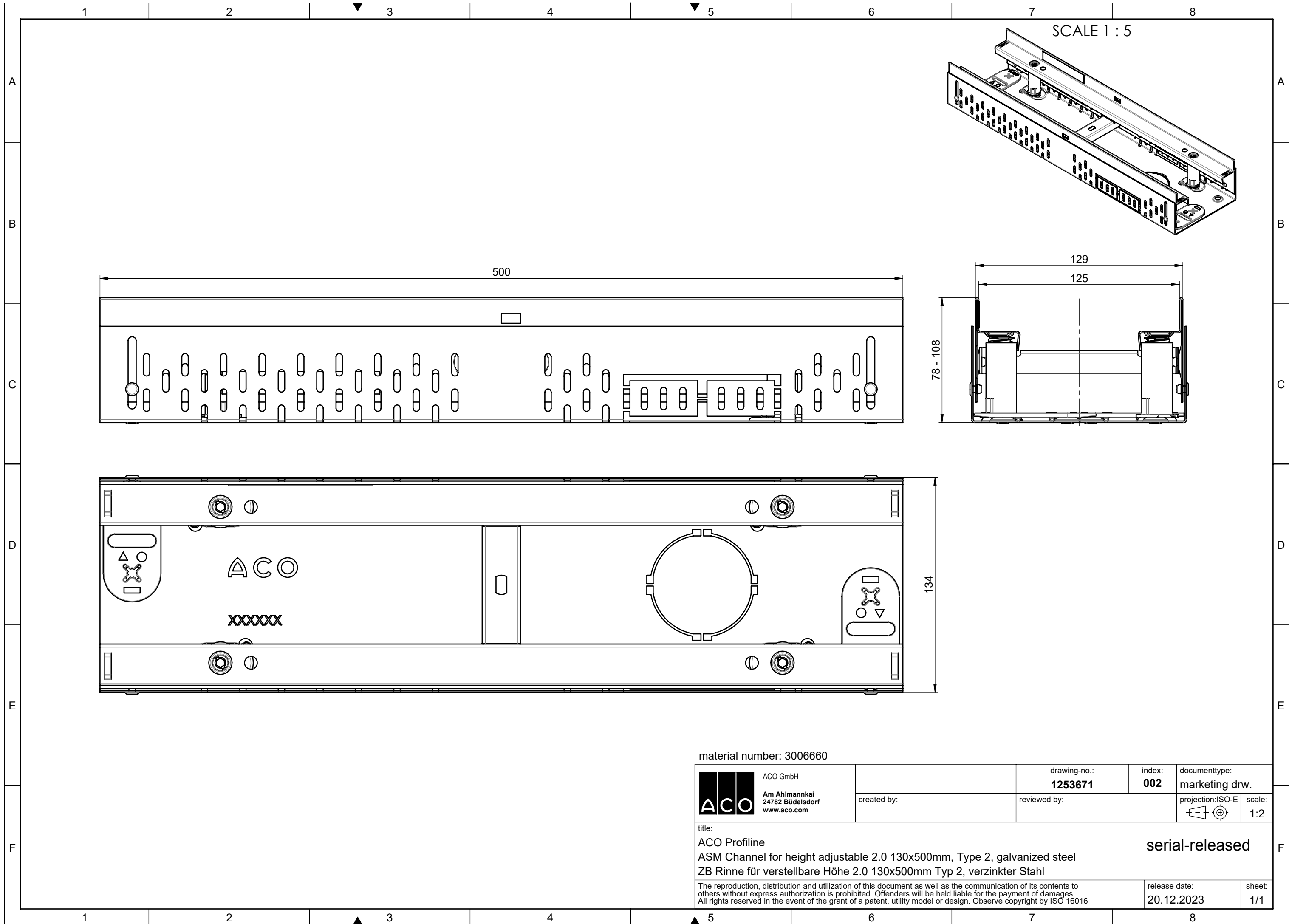

material number: 3006660

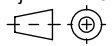
 ACO GmbH Am Ahlmannkai 24782 Büdelsdorf www.aco.com	drawing-no.: <b>1253671</b>	index: <b>002</b>	documenttype: marketing drw.
	created by:	reviewed by:	projection: ISO-E 
title: ACO Profiline ASM Channel for height adjustable 2.0 130x500mm, Type 2, galvanized steel ZB Rinne für verstellbare Höhe 2.0 130x500mm Typ 2, verzinkter Stahl			serial-released
<small>The reproduction, distribution and utilization of this document as well as the communication of its contents to others without express authorization is prohibited. Offenders will be held liable for the payment of damages. All rights reserved in the event of the grant of a patent, utility model or design. Observe copyright by ISO 16016</small>			release date: 20.12.2023
			sheet: 1/1



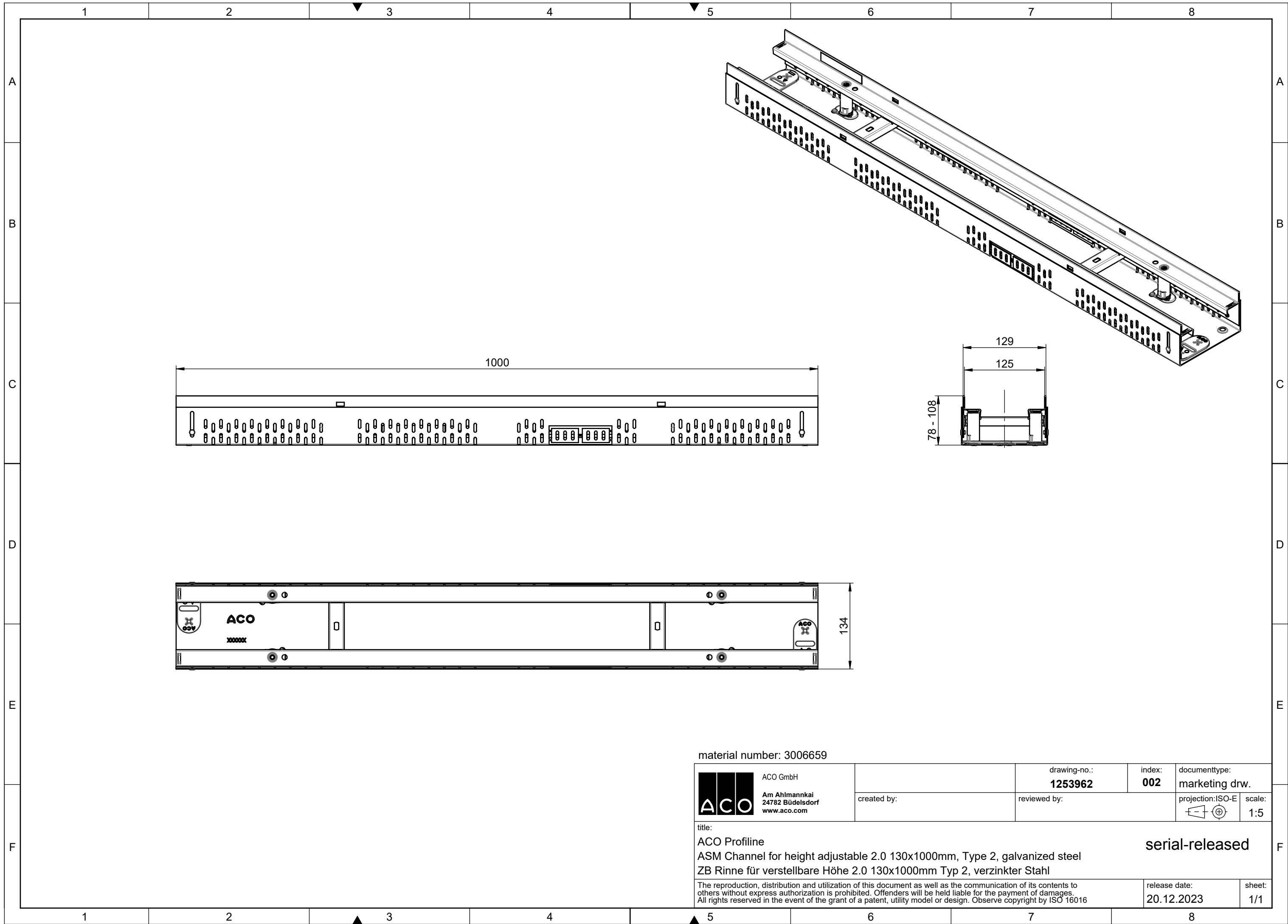

material number: 3006659

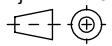
 ACO GmbH Am Ahlmannkai 24782 Büdelsdorf www.aco.com	drawing-no.: <b>1253962</b>	index: <b>002</b>	documenttype: marketing drw.
	created by:	reviewed by:	projection: ISO-E 
title: ACO Profiline ASM Channel for height adjustable 2.0 130x1000mm, Type 2, galvanized steel ZB Rinne für verstellbare Höhe 2.0 130x1000mm Typ 2, verzinkter Stahl			serial-released
<small>The reproduction, distribution and utilization of this document as well as the communication of its contents to others without express authorization is prohibited. Offenders will be held liable for the payment of damages. All rights reserved in the event of the grant of a patent, utility model or design. Observe copyright by ISO 16016</small>			release date: 20.12.2023
			sheet: 1/1

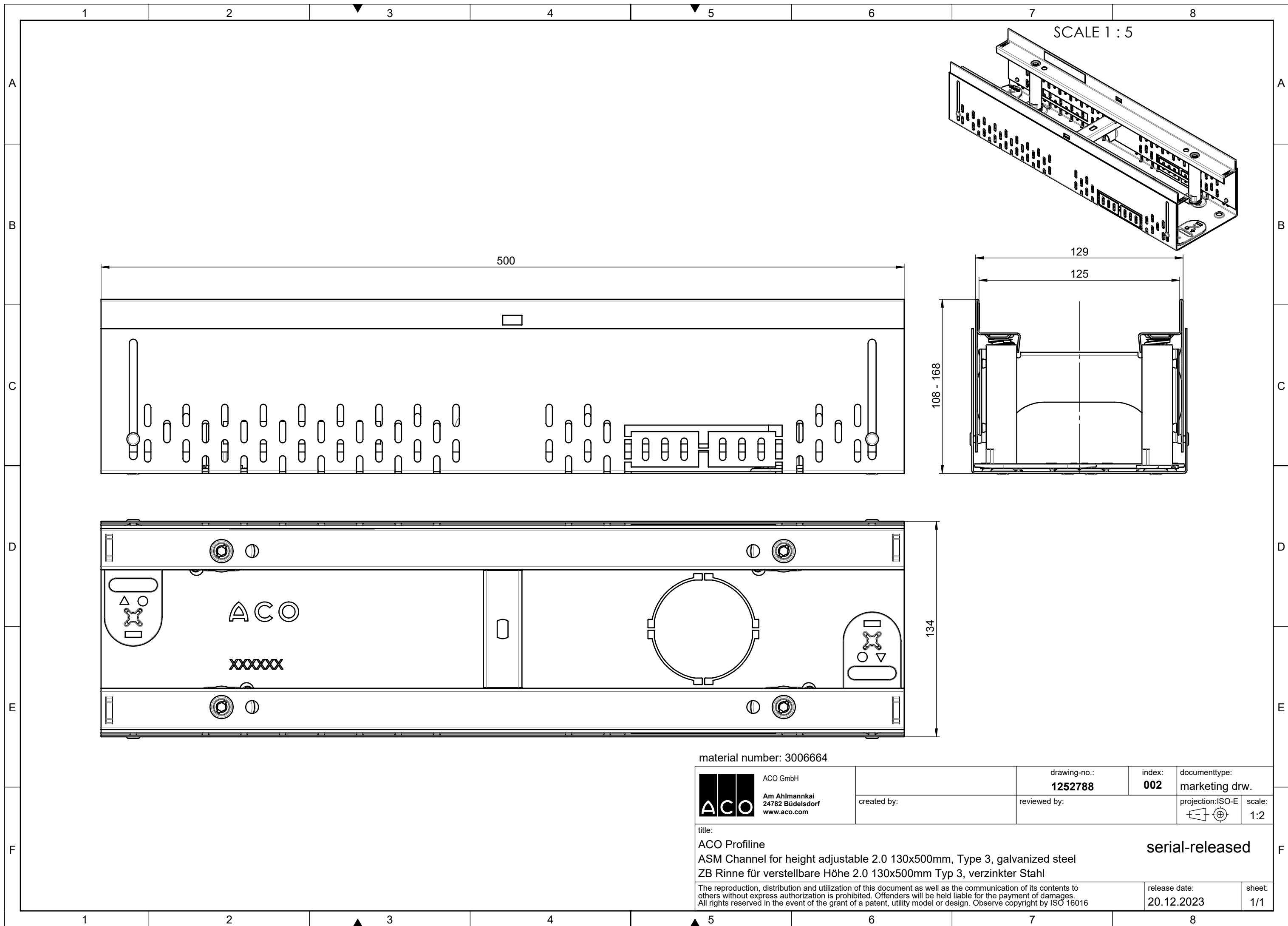

material number: 3006664

 ACO GmbH Am Ahlmannkai 24782 Büdelsdorf www.aco.com	created by:	drawing-no.: <b>1252788</b>	index: <b>002</b>	documenttype: marketing drw.
	reviewed by:	projection: ISO-E	scale: 1:2	
title: ACO Profiline ASM Channel for height adjustable 2.0 130x500mm, Type 3, galvanized steel ZB Rinne für verstellbare Höhe 2.0 130x500mm Typ 3, verzinkter Stahl				serial-released
The reproduction, distribution and utilization of this document as well as the communication of its contents to others without express authorization is prohibited. Offenders will be held liable for the payment of damages. All rights reserved in the event of the grant of a patent, utility model or design. Observe copyright by ISO 16016			release date: 20.12.2023	sheet: 1/1

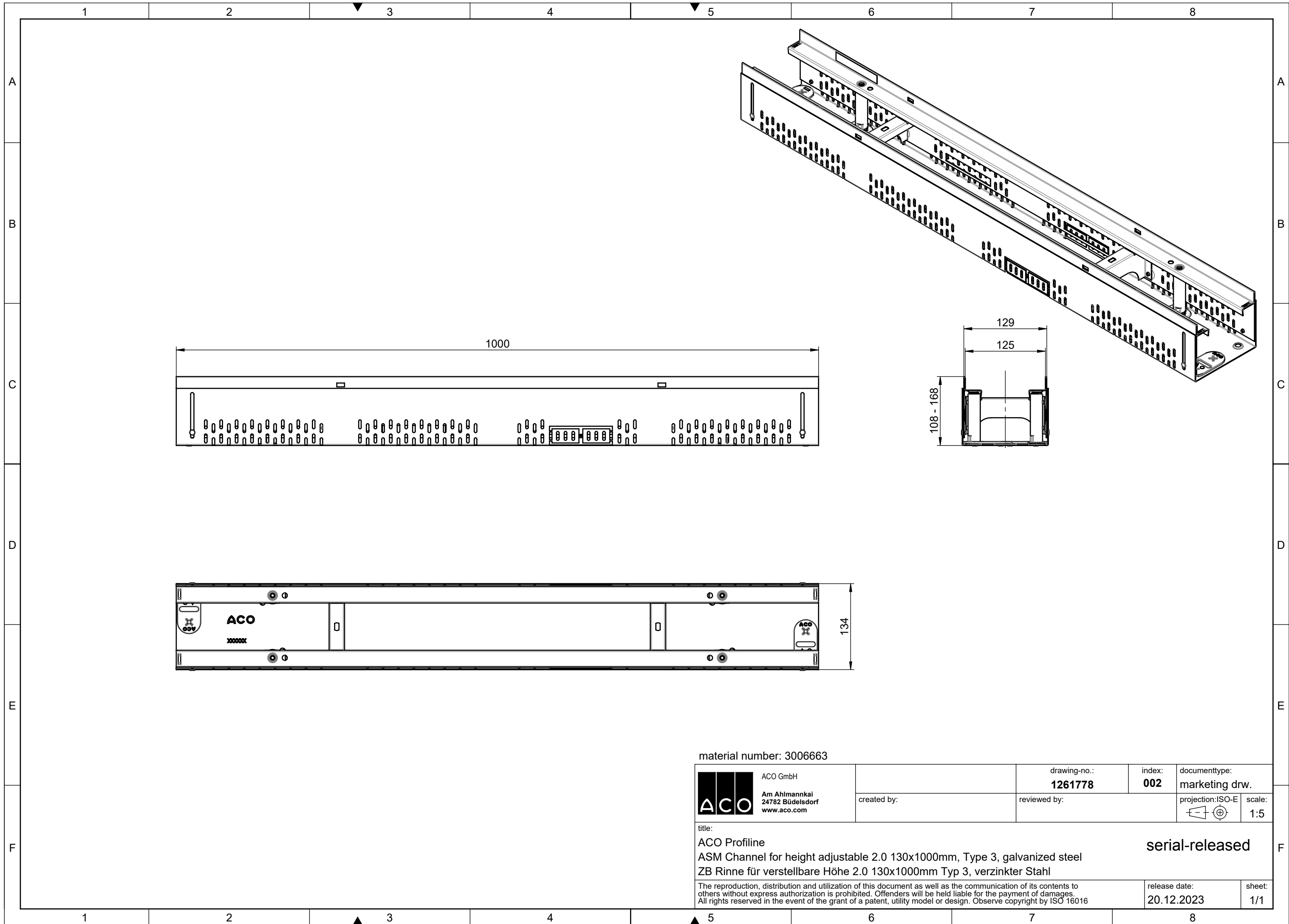

material number: 3006663

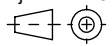
 ACO GmbH Am Ahmannkai 24782 Büdelsdorf www.aco.com	drawing-no.: <b>1261778</b>	index: <b>002</b>	documenttype: marketing drw.
	created by:	reviewed by:	projection: ISO-E 
title: ACO Profiline ASM Channel for height adjustable 2.0 130x1000mm, Type 3, galvanized steel ZB Rinne für verstellbare Höhe 2.0 130x1000mm Typ 3, verzinkter Stahl			serial-released
<small>The reproduction, distribution and utilization of this document as well as the communication of its contents to others without express authorization is prohibited. Offenders will be held liable for the payment of damages. All rights reserved in the event of the grant of a patent, utility model or design. Observe copyright by ISO 16016</small>			release date: 20.12.2023
			sheet: 1/1

S:\projekte\2019\001\_A3\_Vertrieb\22

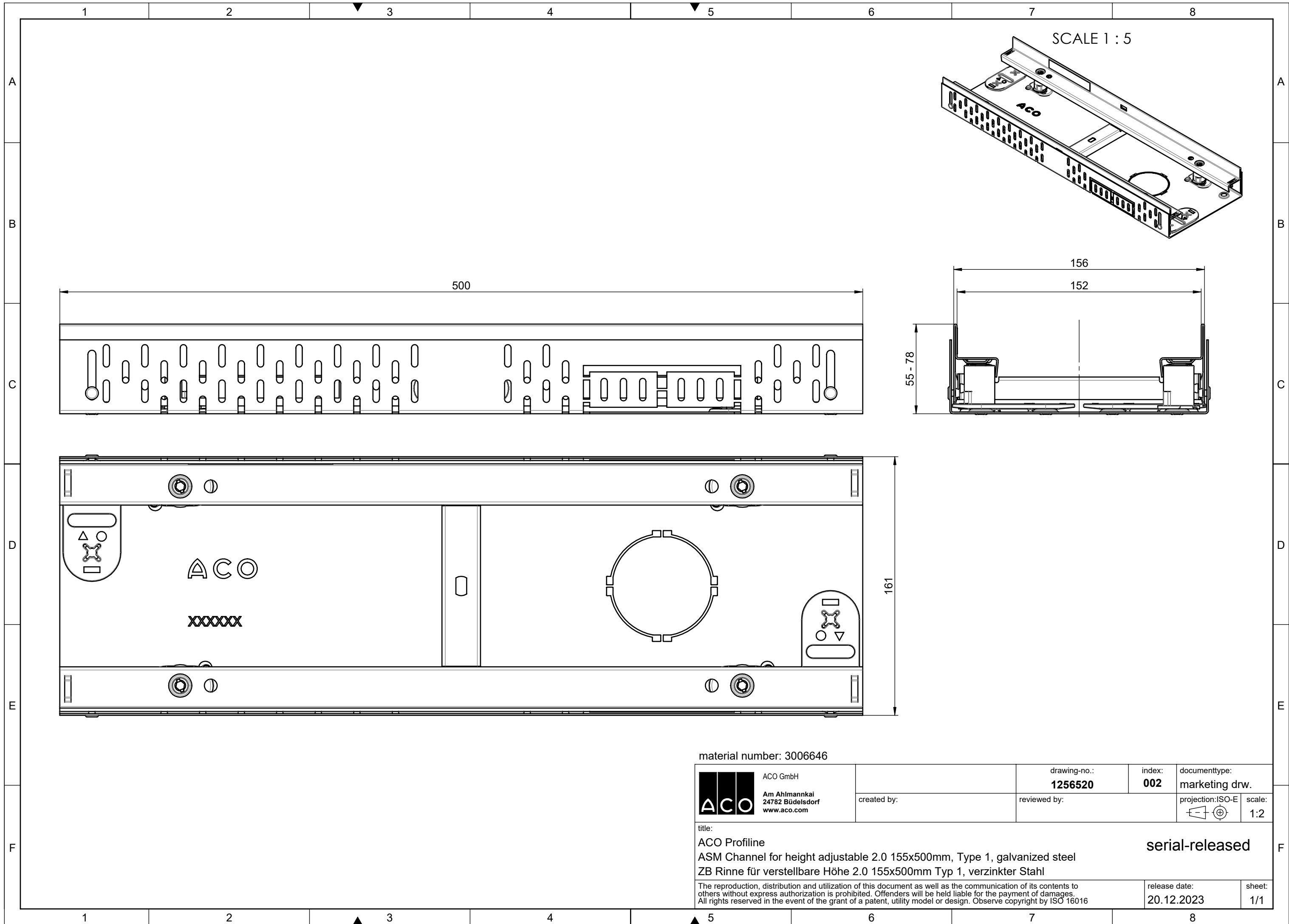

material number: 3006646

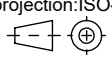
 ACO GmbH Am Ahlmannkai 24782 Büdelsdorf www.aco.com	drawing-no.: <b>1256520</b>	index: <b>002</b>	documenttype: marketing drw.
	created by:	reviewed by:	projection: ISO-E 
title: ACO Profiline ASM Channel for height adjustable 2.0 155x500mm, Type 1, galvanized steel ZB Rinne für verstellbare Höhe 2.0 155x500mm Typ 1, verzinkter Stahl			serial-released
<small>The reproduction, distribution and utilization of this document as well as the communication of its contents to others without express authorization is prohibited. Offenders will be held liable for the payment of damages. All rights reserved in the event of the grant of a patent, utility model or design. Observe copyright by ISO 16016</small>			release date: 20.12.2023
			sheet: 1/1

S:\projekte\2019\001\_A3\_Versand\22

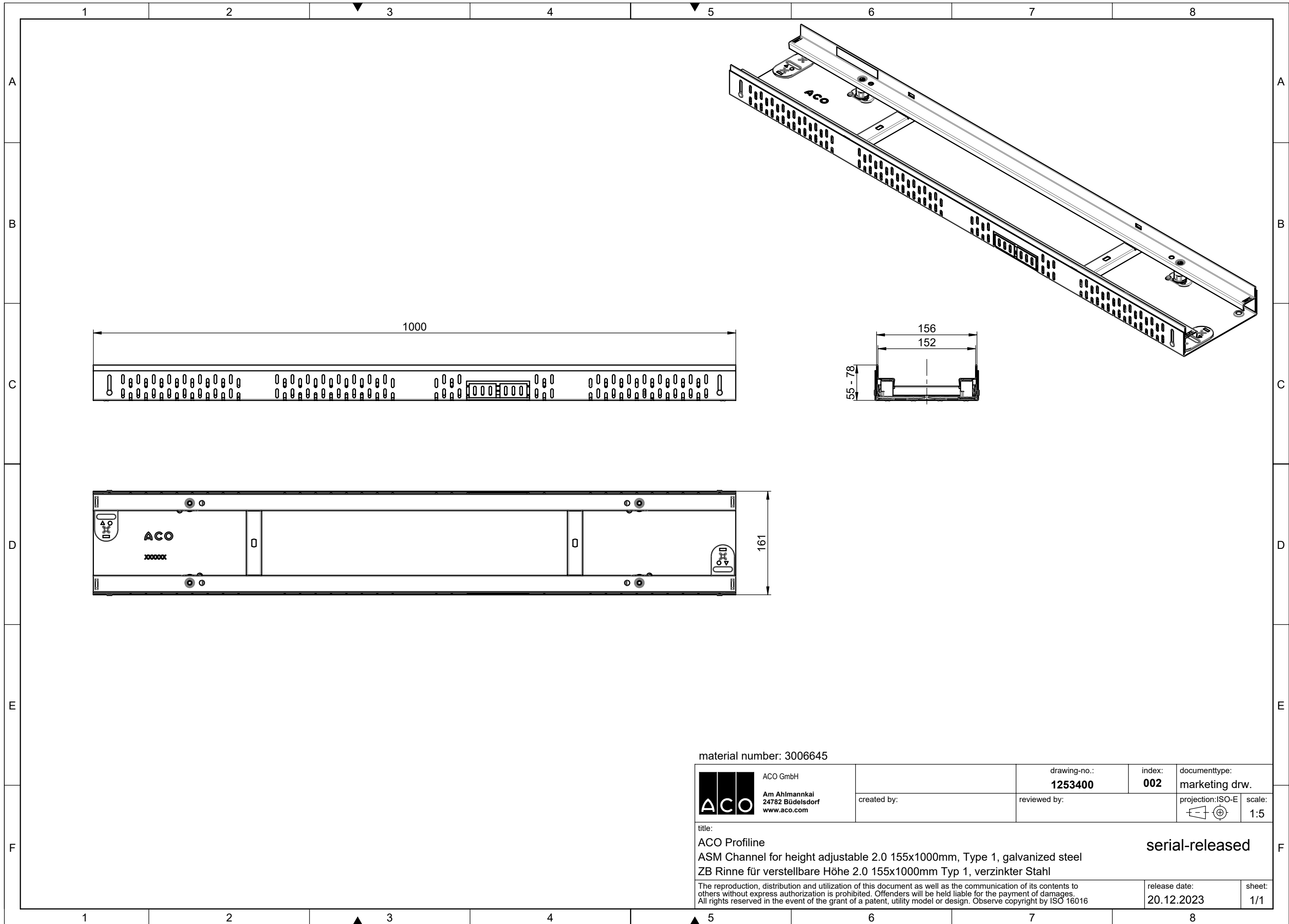

material number: 3006645

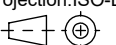
 ACO GmbH Am Ahlmannkai 24782 Büdelsdorf www.aco.com	drawing-no.: <b>1253400</b>	index: <b>002</b>	documenttype: marketing drw.
	created by:	reviewed by:	projection: ISO-E 
title: ACO Profiline ASM Channel for height adjustable 2.0 155x1000mm, Type 1, galvanized steel ZB Rinne für verstellbare Höhe 2.0 155x1000mm Typ 1, verzinkter Stahl			serial-released
<small>The reproduction, distribution and utilization of this document as well as the communication of its contents to others without express authorization is prohibited. Offenders will be held liable for the payment of damages. All rights reserved in the event of the grant of a patent, utility model or design. Observe copyright by ISO 16016</small>			release date: 20.12.2023
			sheet: 1/1

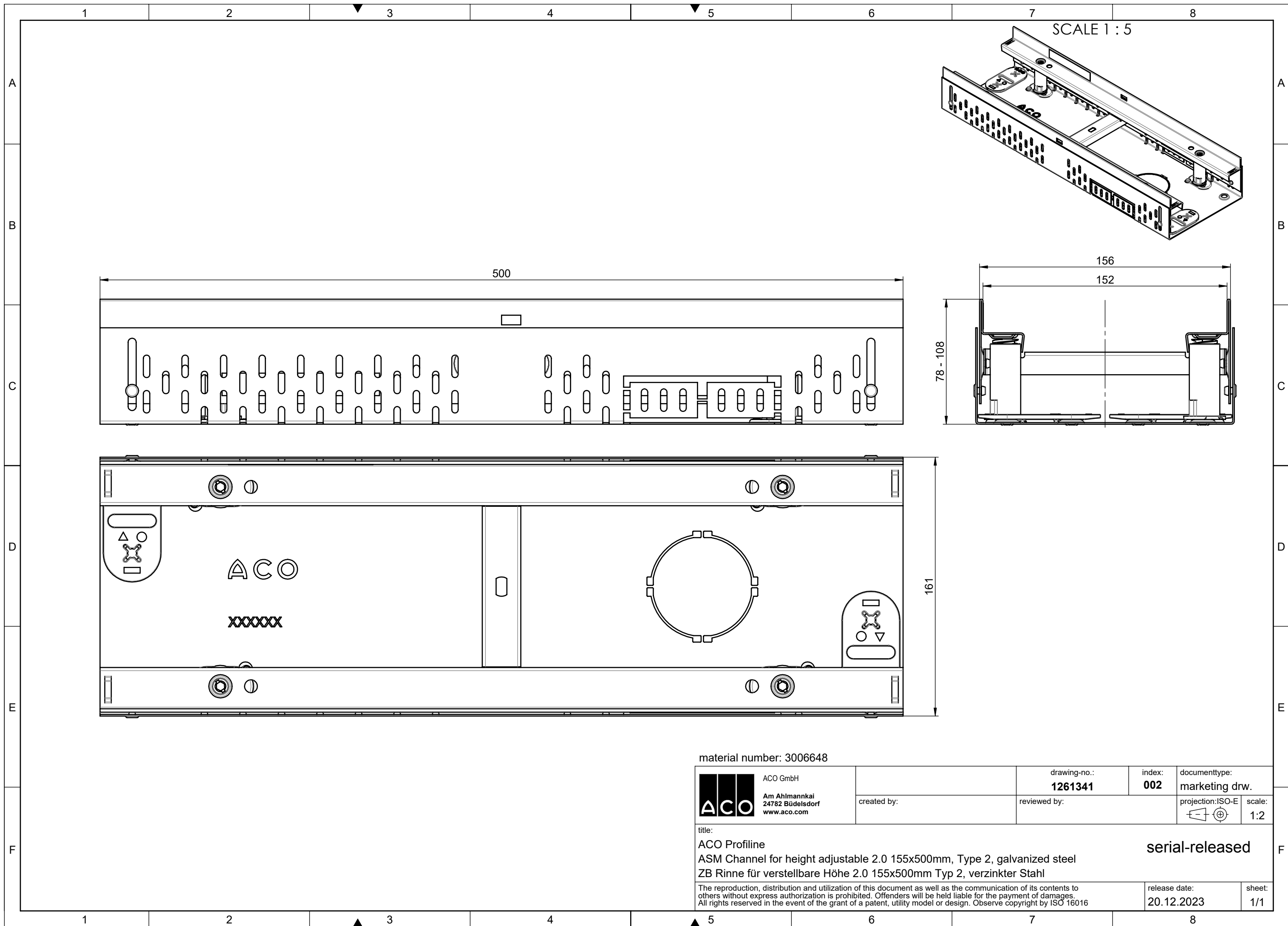

SCALE 1 : 5

500

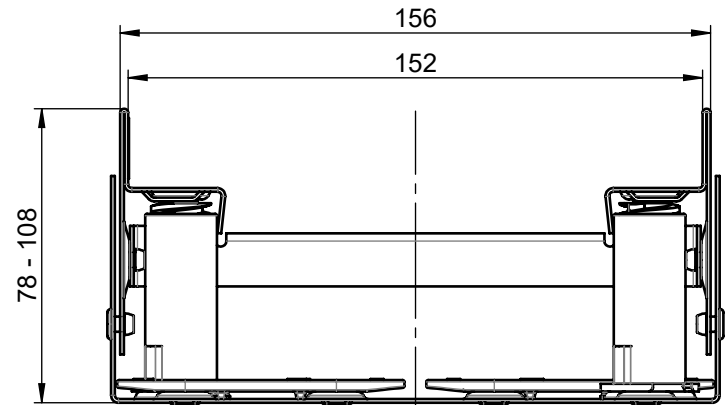

78 - 108

156

152

161

ACO

XXXXXX

material number: 3006648

 ACO GmbH Am Ahlmannkai 24782 Büdelsdorf www.aco.com	created by:	drawing-no.: <b>1261341</b>	index: <b>002</b>	documenttype: marketing drw.
	reviewed by:	projection: ISO-E	scale: 1:2	
title: ACO Proffline ASM Channel for height adjustable 2.0 155x500mm, Type 2, galvanized steel ZB Rinne für verstellbare Höhe 2.0 155x500mm Typ 2, verzinkter Stahl				serial-released
The reproduction, distribution and utilization of this document as well as the communication of its contents to others without express authorization is prohibited. Offenders will be held liable for the payment of damages. All rights reserved in the event of the grant of a patent, utility model or design. Observe copyright by ISO 16016			release date: 20.12.2023	sheet: 1/1

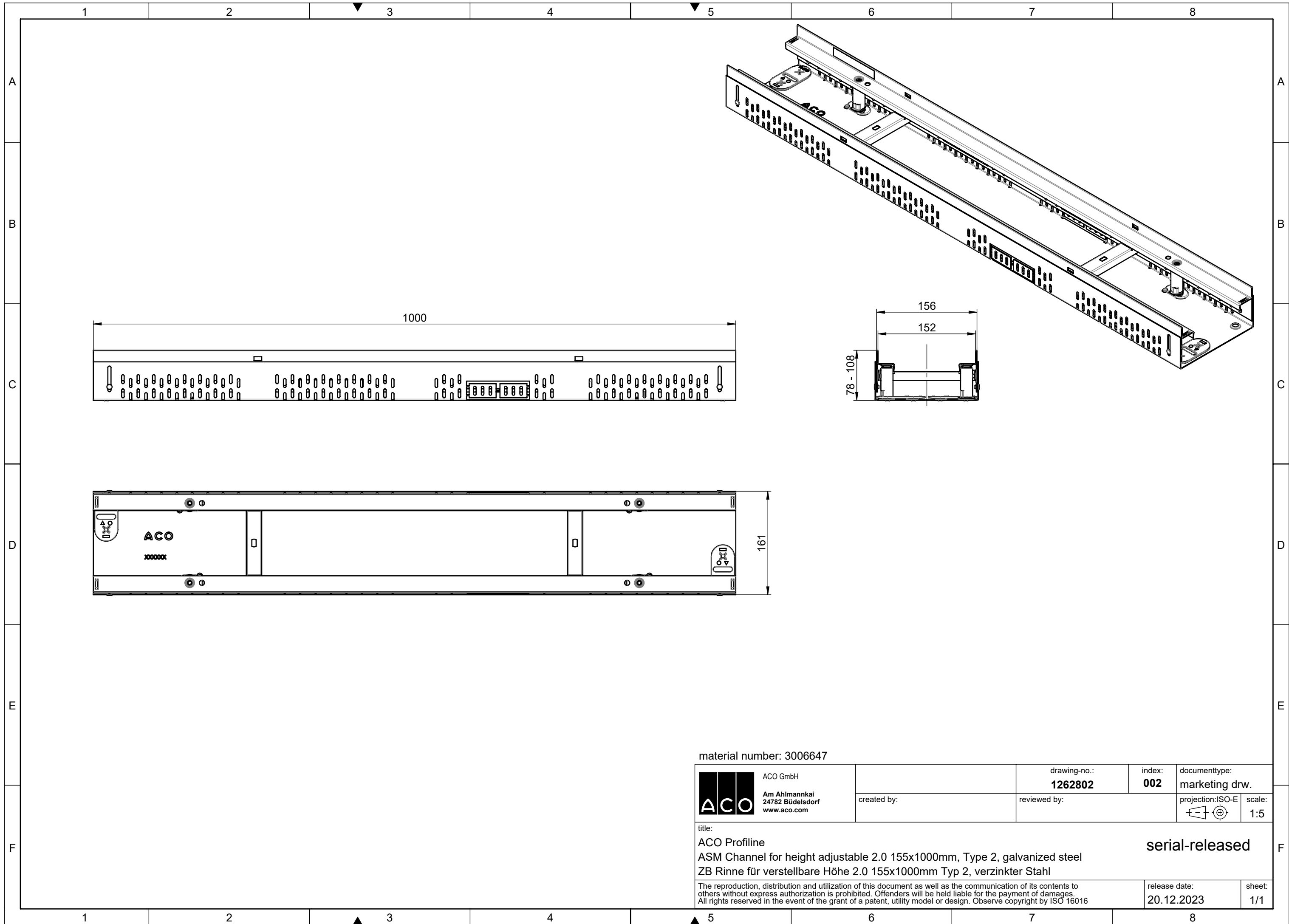

material number: 3006647

 ACO GmbH Am Ahlmannkai 24782 Büdelsdorf www.aco.com	drawing-no.: <b>1262802</b>	index: <b>002</b>	documenttype: marketing drw.
	created by:	reviewed by:	projection: ISO-E 
title: ACO Proffline ASM Channel for height adjustable 2.0 155x1000mm, Type 2, galvanized steel ZB Rinne für verstellbare Höhe 2.0 155x1000mm Typ 2, verzinkter Stahl			serial-released
<small>The reproduction, distribution and utilization of this document as well as the communication of its contents to others without express authorization is prohibited. Offenders will be held liable for the payment of damages. All rights reserved in the event of the grant of a patent, utility model or design. Observe copyright by ISO 16016</small>			release date: 20.12.2023
			sheet: 1/1

SCALE 1 : 5

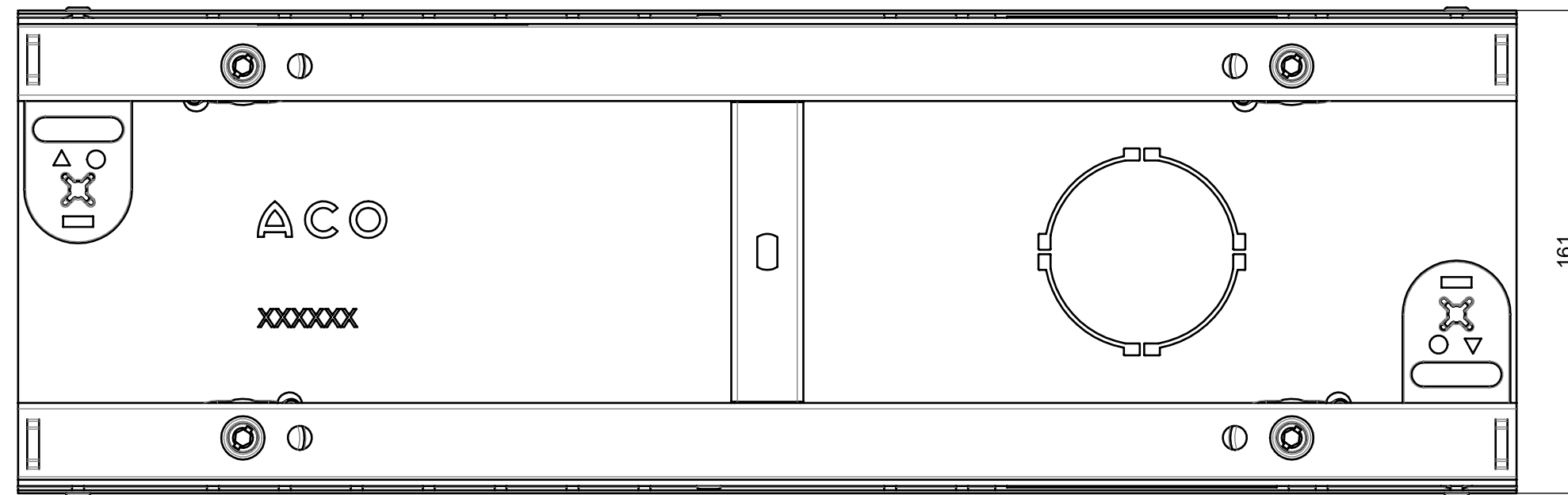
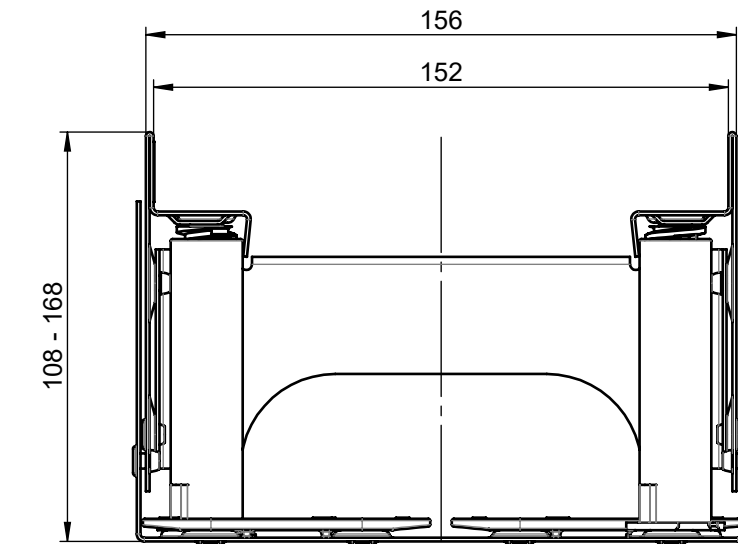
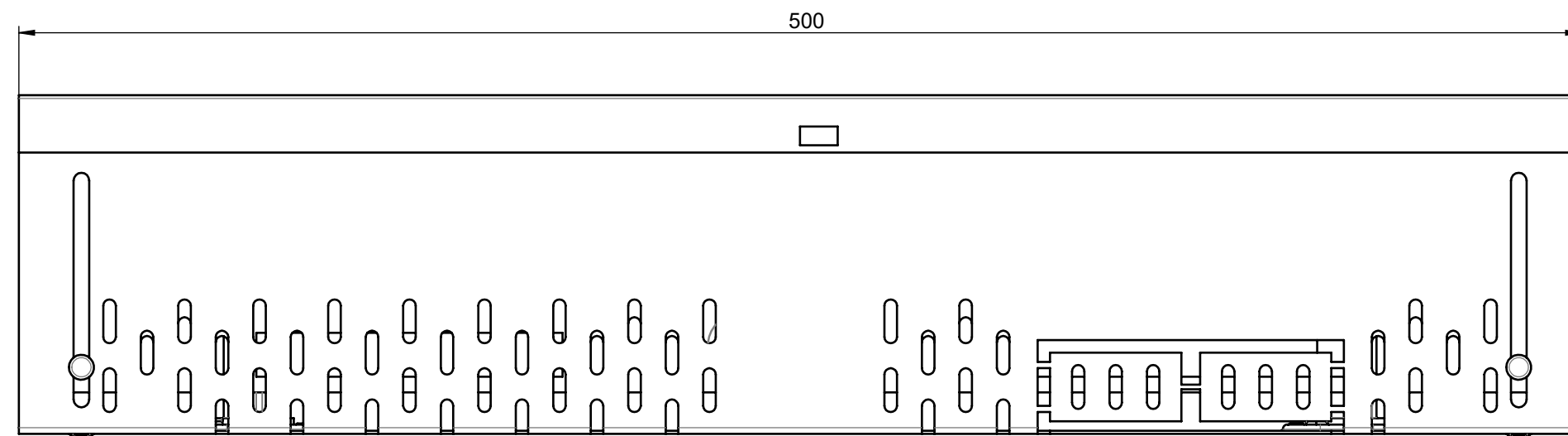
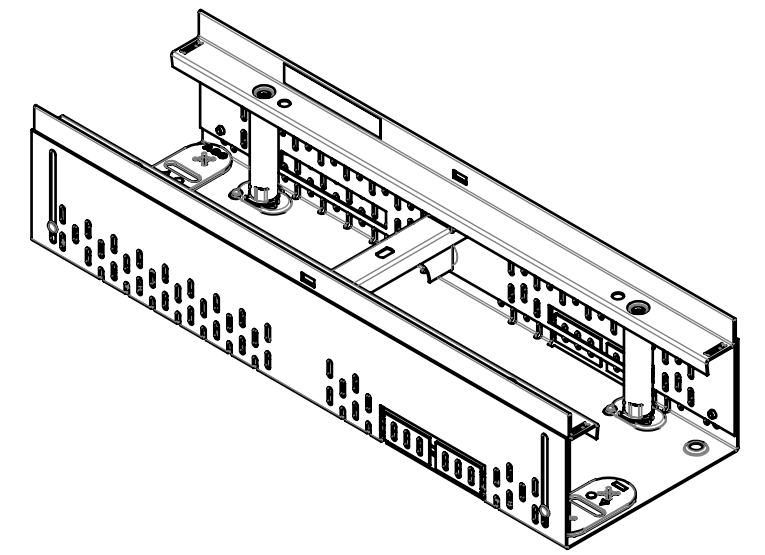

material number: 3006650

 ACO GmbH Am Ahlmannkai 24782 Büdelsdorf www.aco.com	drawing-no.: <b>1256063</b>	index: <b>002</b>	documenttype: marketing drw.
	created by:	reviewed by:	projection: ISO-E scale: 1:2

title:  
**ACO Profiline**  
 ASM Channel for height adjustable 2.0 155x500mm, Type 3, galvanized steel  
 ZB Rinne für verstellbare Höhe 2.0 155x500mm Typ 3, verzinkter Stahl

serial-released

The reproduction, distribution and utilization of this document as well as the communication of its contents to others without express authorization is prohibited. Offenders will be held liable for the payment of damages. All rights reserved in the event of the grant of a patent, utility model or design. Observe copyright by ISO 16016

release date:  
20.12.2023

sheet:  
1/1



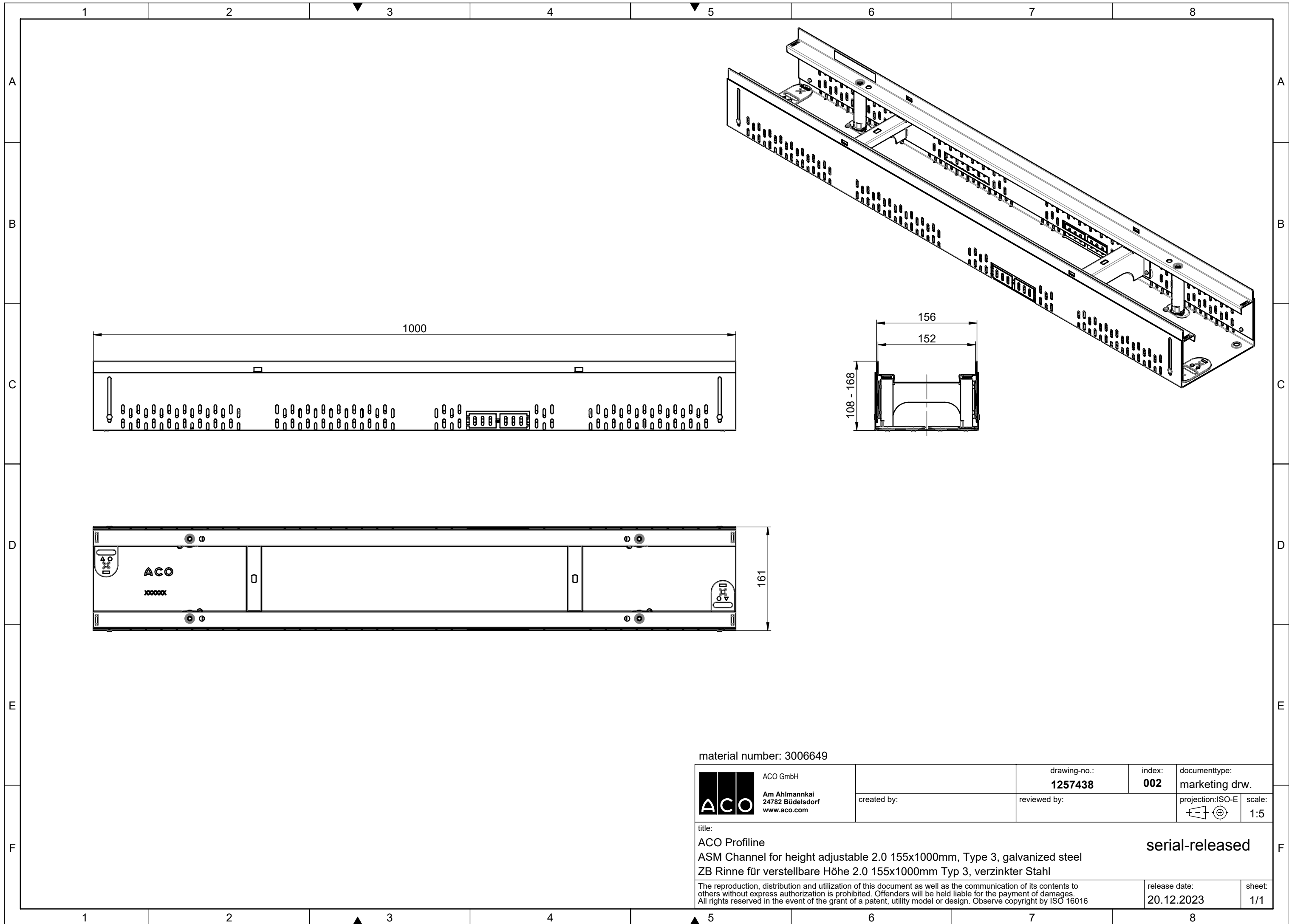

material number: 3006649

 ACO GmbH Am Ahlmannkai 24782 Büdelsdorf www.aco.com	drawing-no.: <b>1257438</b>	index: <b>002</b>	documenttype: marketing drw.
	created by:	reviewed by:	projection: ISO-E 
title: ACO Profiline ASM Channel for height adjustable 2.0 155x1000mm, Type 3, galvanized steel ZB Rinne für verstellbare Höhe 2.0 155x1000mm Typ 3, verzinkter Stahl			serial-released
<small>The reproduction, distribution and utilization of this document as well as the communication of its contents to others without express authorization is prohibited. Offenders will be held liable for the payment of damages. All rights reserved in the event of the grant of a patent, utility model or design. Observe copyright by ISO 16016</small>			release date: 20.12.2023
			sheet: 1/1

1 2 3 4 5 6 7 8 9 10 11 12

A  
B  
C  
D  
E  
F  
G  
H

SCALE 1 : 5

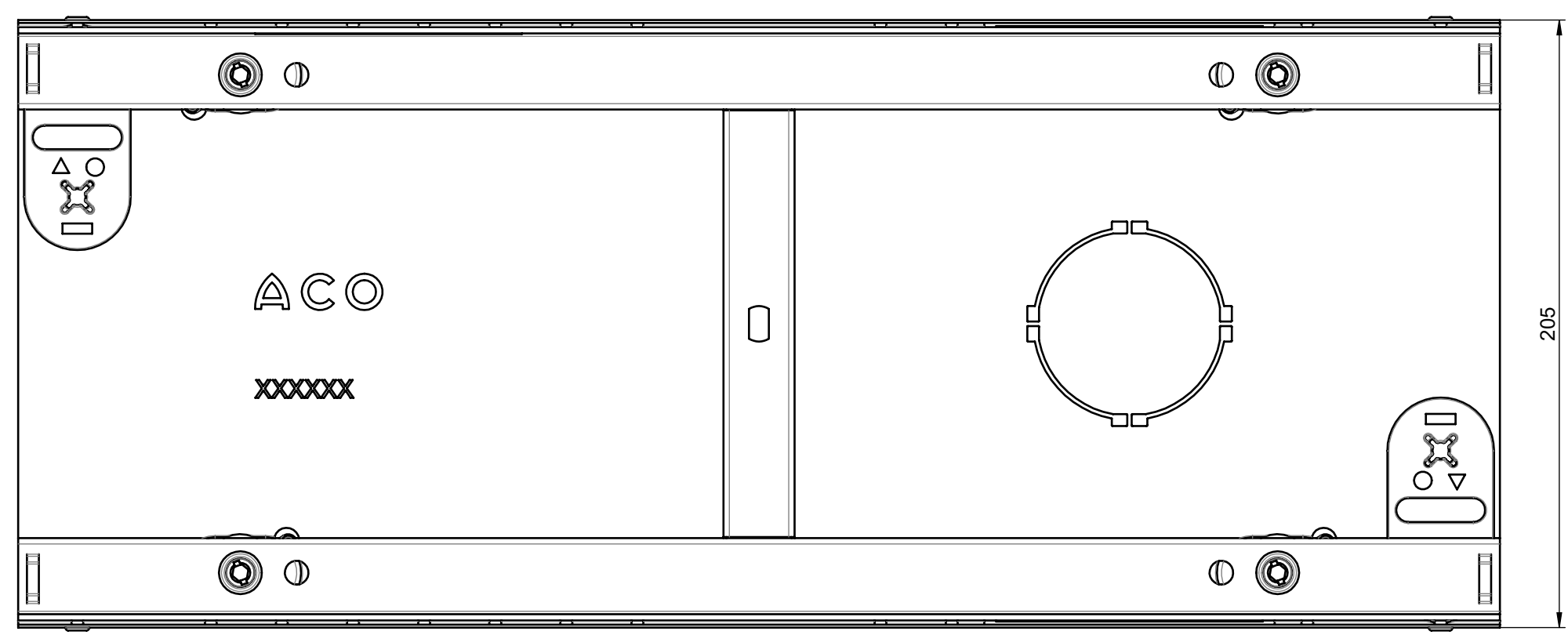
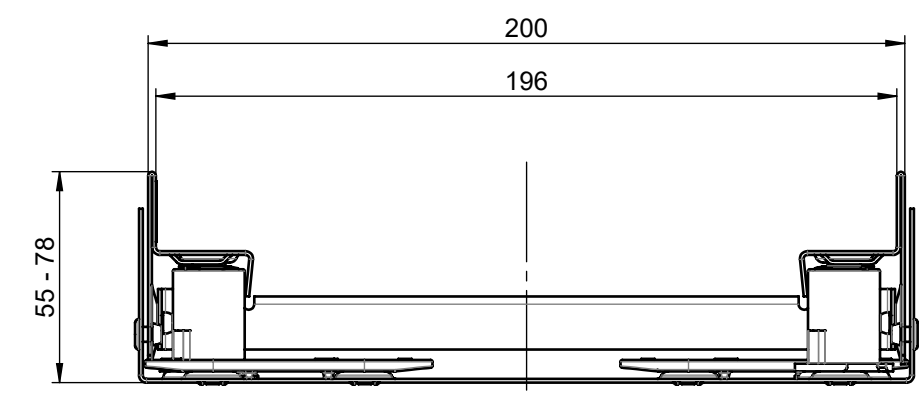
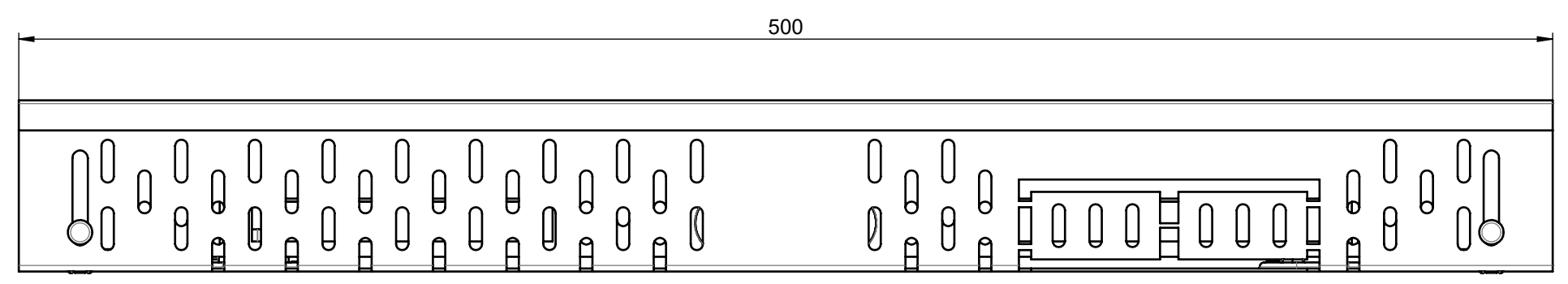
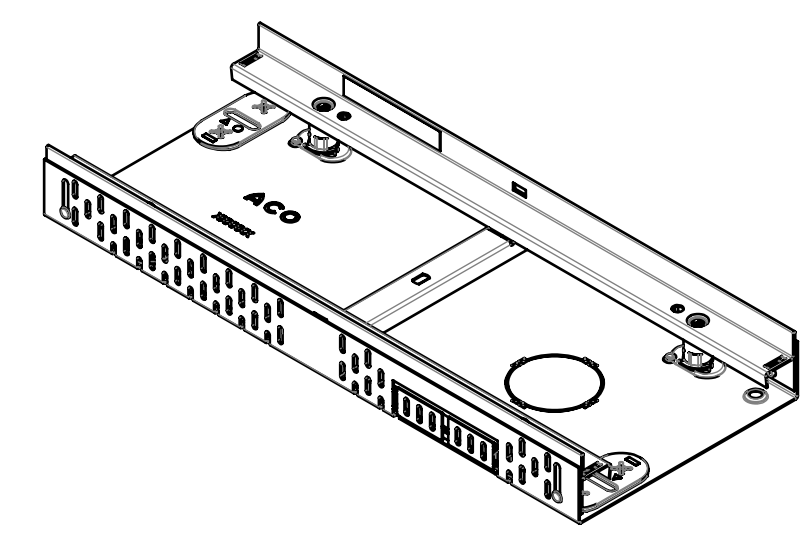

material number: 3006694

 ACO GmbH Am Ahlmannkai 24782 Büdelsdorf www.aco.com	drawing-no.: <b>1256157</b>	index: <b>002</b>	documenttype: marketing drw.
	created by:	reviewed by:	projection: ISO-E scale: 1:2

title:  
**ACO Profiline**  
 ASM Channel for height adjustable 2.0 200x500mm, Type 1, galvanized steel  
 ZB Rinne für verstellbare Höhe 2.0 200x500mm Typ 1, verzinkter Stahl

serial-released

The reproduction, distribution and utilization of this document as well as the communication of its contents to others without express authorization is prohibited. Offenders will be held liable for the payment of damages. All rights reserved in the event of the grant of a patent, utility model or design. Observe copyright by ISO 16016

release date: 20.12.2023 sheet: 1/1

1 2 3 4 5 6 7 8 9 10 11 12

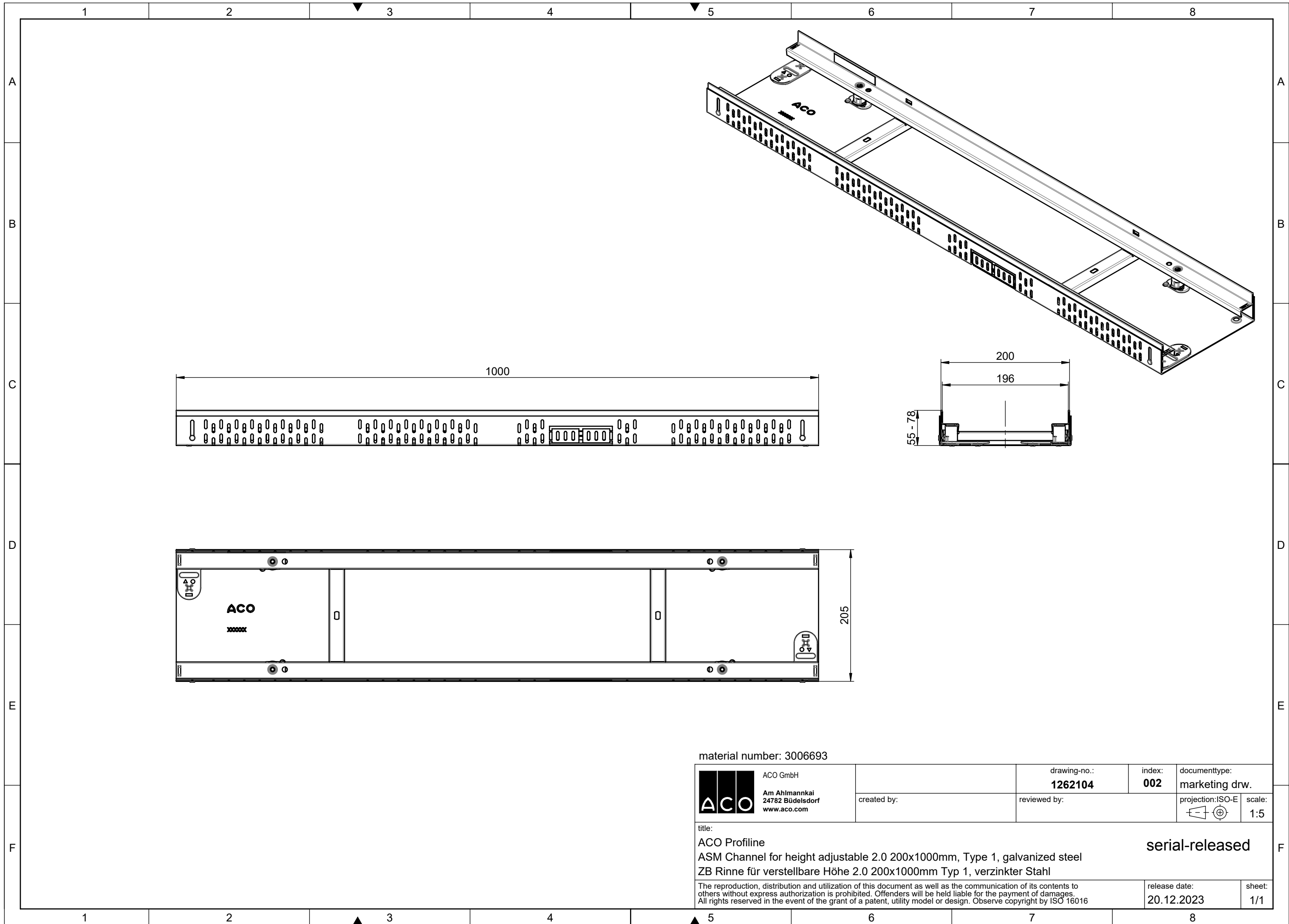

material number: 3006693

 ACO GmbH Am Ahlmannkai 24782 Büdelsdorf www.aco.com	drawing-no.: <b>1262104</b>	index: <b>002</b>	documenttype: marketing drw.
	created by:	reviewed by:	projection: ISO-E scale: 1:5
title: <b>ACO Profiline</b> <b>ASM Channel for height adjustable 2.0 200x1000mm, Type 1, galvanized steel</b> <b>ZB Rinne für verstellbare Höhe 2.0 200x1000mm Typ 1, verzinkter Stahl</b>			<b>serial-released</b>
<small>The reproduction, distribution and utilization of this document as well as the communication of its contents to others without express authorization is prohibited. Offenders will be held liable for the payment of damages. All rights reserved in the event of the grant of a patent, utility model or design. Observe copyright by ISO 16016</small>			release date: <b>20.12.2023</b> sheet: <b>1/1</b>

S:\projekte\2019\001\_A3\_Versatz\_22

1 2 3 4 5 6 7 8 9 10 11 12

A  
B  
C  
D  
E  
F  
G  
H

SCALE 1 : 5

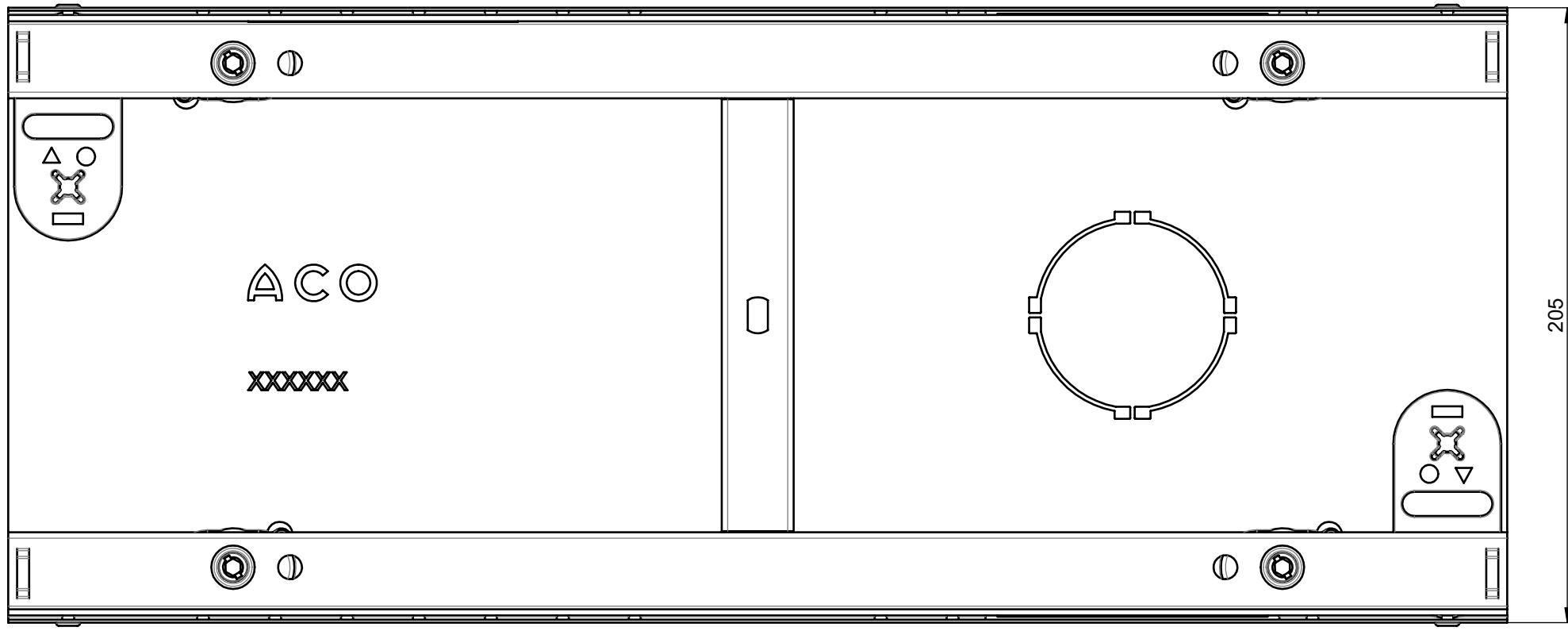
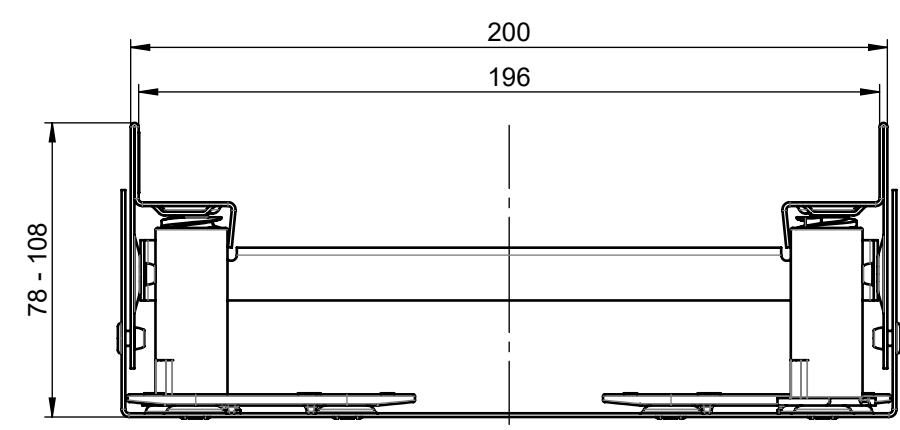
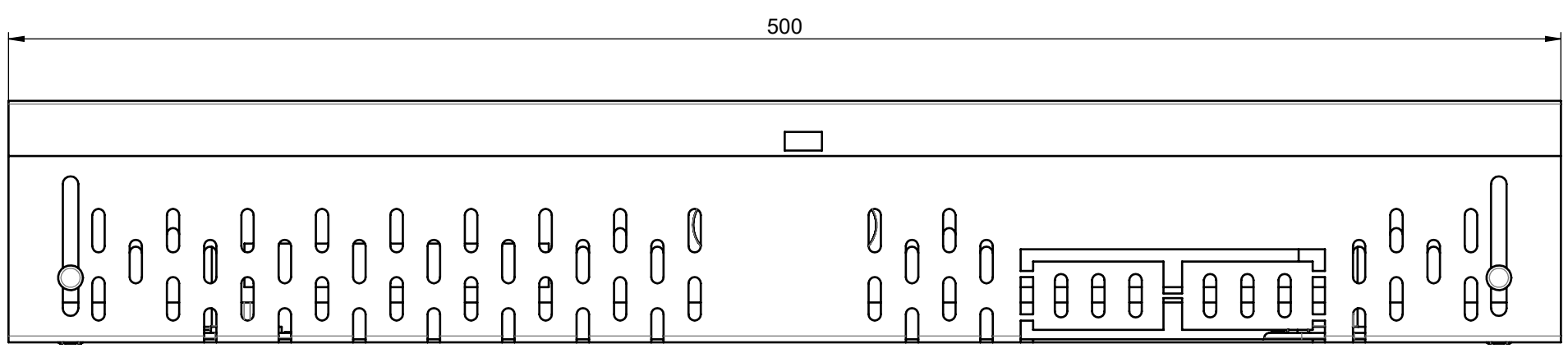
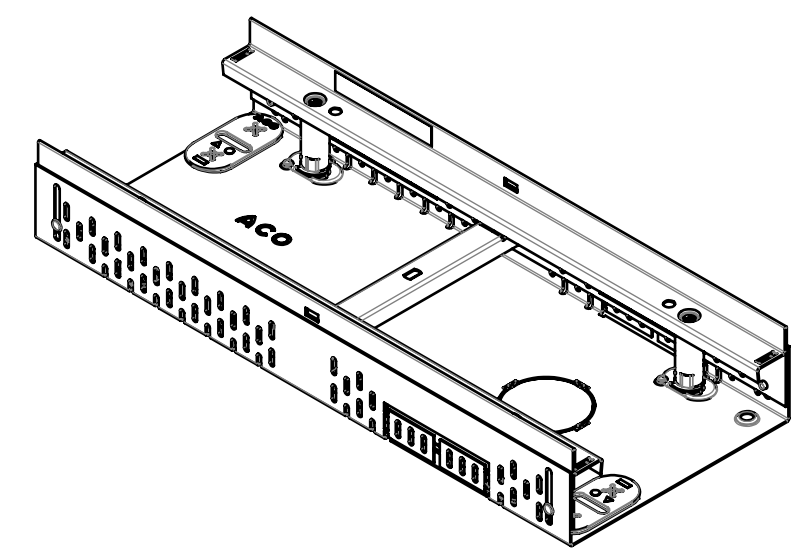

material number: 3006696

 ACO GmbH Am Ahlmannkai 24782 Büdelsdorf www.aco.com	drawing-no.: <b>1258663</b>	index: <b>002</b>	documenttype: marketing drw.
	created by:	reviewed by:	projection: ISO-E scale: 1:2

title:  
**ACO Profiline**  
 ASM Channel for height adjustable 2.0 200x500mm, Type 2, galvanized steel  
 ZB Rinne für verstellbare Höhe 2.0 200x500mm Typ 2, verzinkter Stahl

serial-released

The reproduction, distribution and utilization of this document as well as the communication of its contents to others without express authorization is prohibited. Offenders will be held liable for the payment of damages. All rights reserved in the event of the grant of a patent, utility model or design. Observe copyright by ISO 16016

release date:  
20.12.2023

sheet:  
1/1

1 2 3 4 5 6 7 8 9 10 11 12

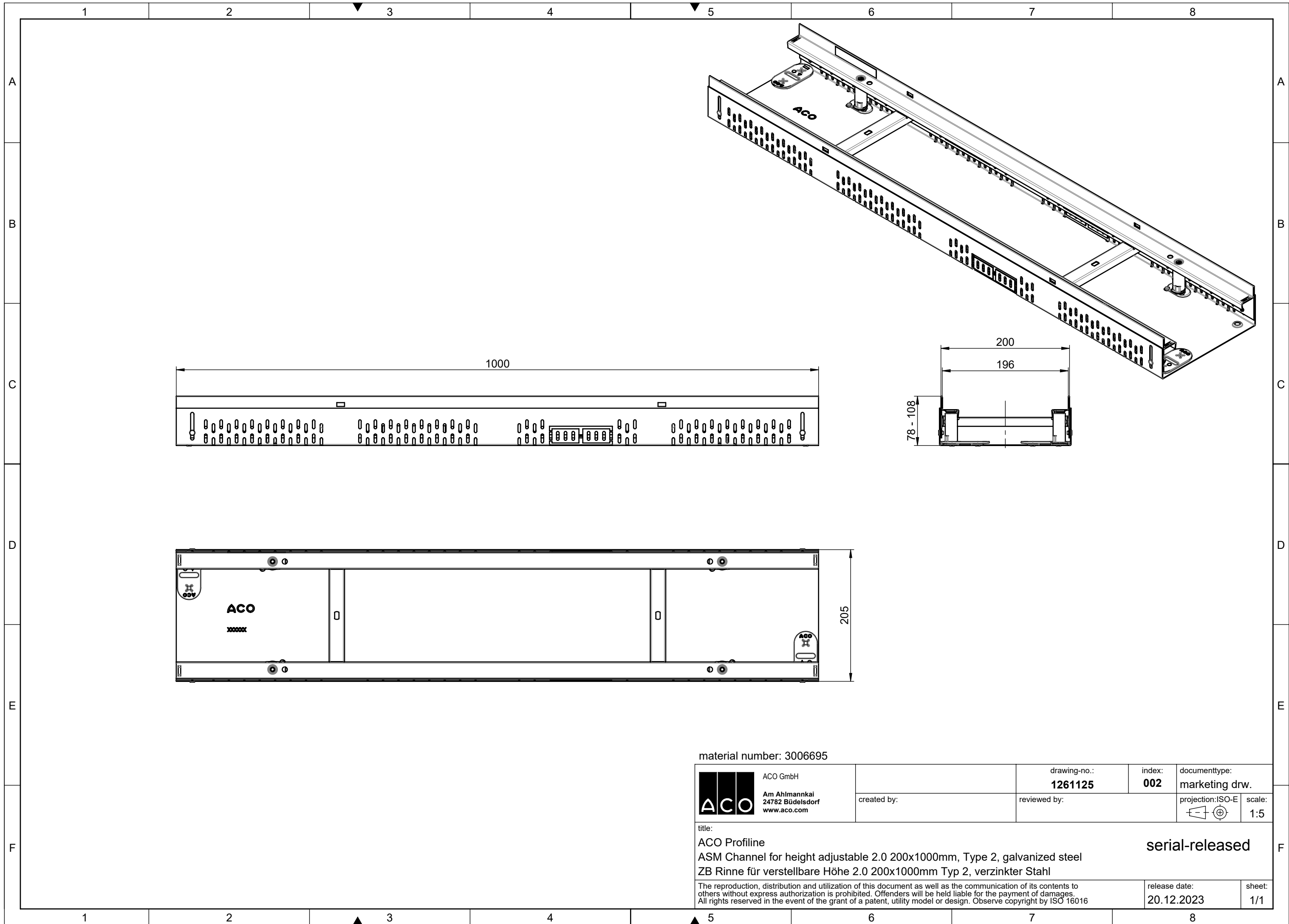

material number: 3006695

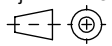
 ACO GmbH Am Ahlmannkai 24782 Büdelsdorf www.aco.com	drawing-no.: <b>1261125</b>	index: <b>002</b>	documenttype: marketing drw.
	created by:	reviewed by:	projection: ISO-E 
title: ACO Profiline ASM Channel for height adjustable 2.0 200x1000mm, Type 2, galvanized steel ZB Rinne für verstellbare Höhe 2.0 200x1000mm Typ 2, verzinkter Stahl			serial-released
<small>The reproduction, distribution and utilization of this document as well as the communication of its contents to others without express authorization is prohibited. Offenders will be held liable for the payment of damages. All rights reserved in the event of the grant of a patent, utility model or design. Observe copyright by ISO 16016</small>			release date: 20.12.2023
			sheet: 1/1

S:\projekte\2019\001\_A3\_Versatz\_22

1 2 3 4 5 6 7 8 9 10 11 12

A

B

C

D

E

F

G

H

SCALE 1 : 5

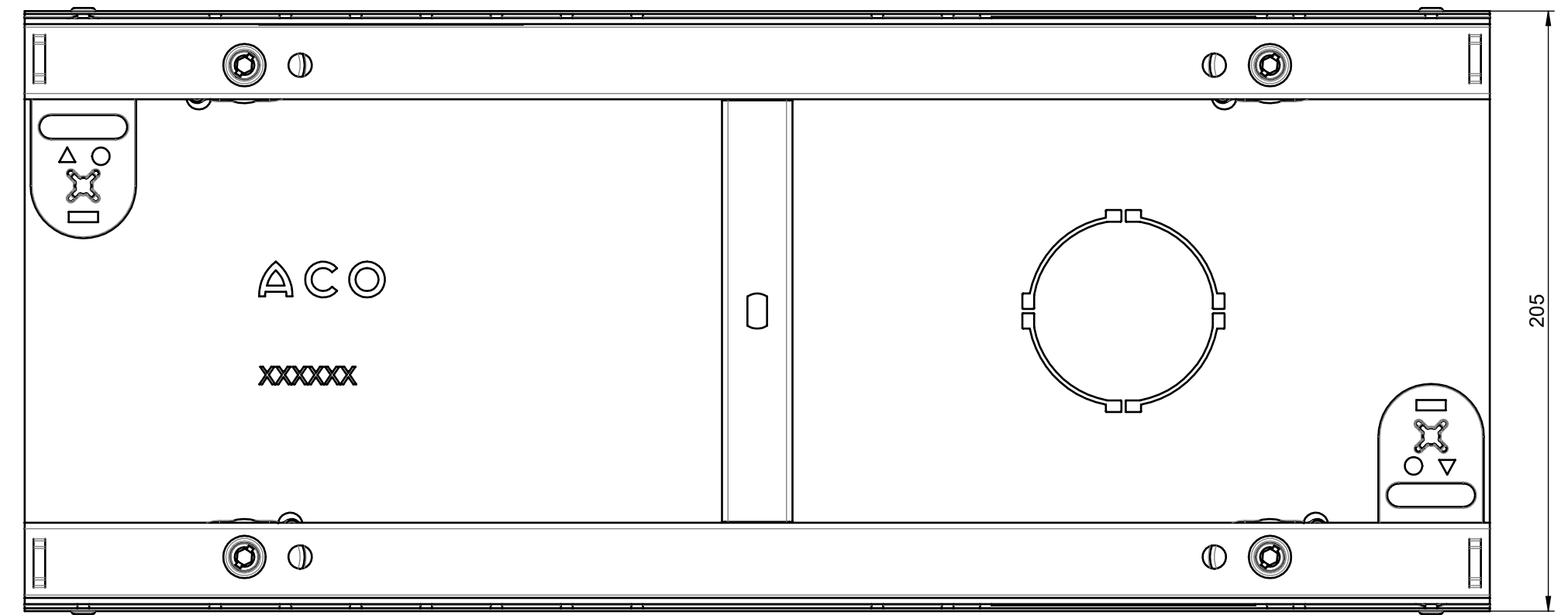
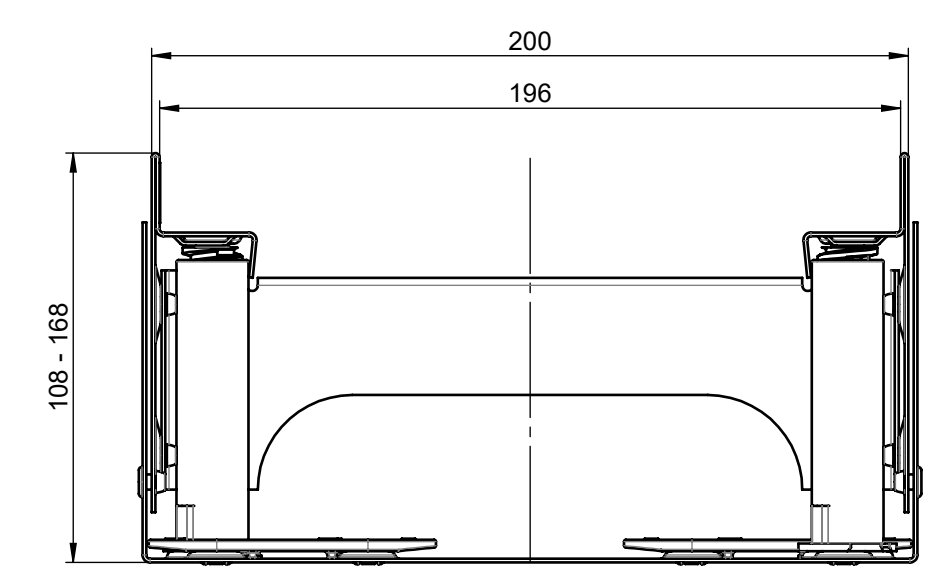
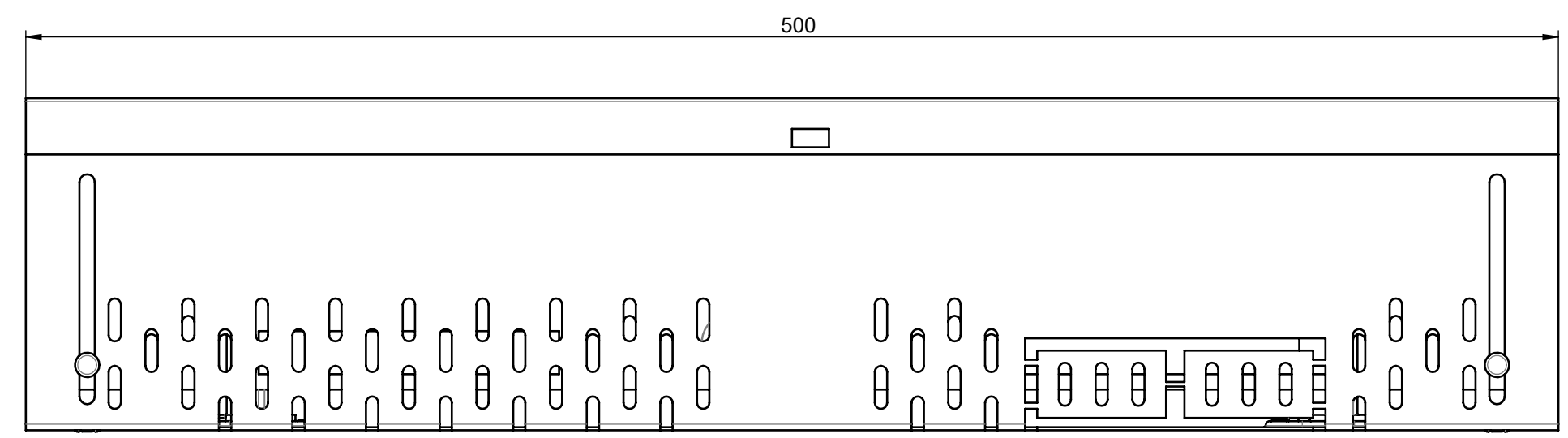
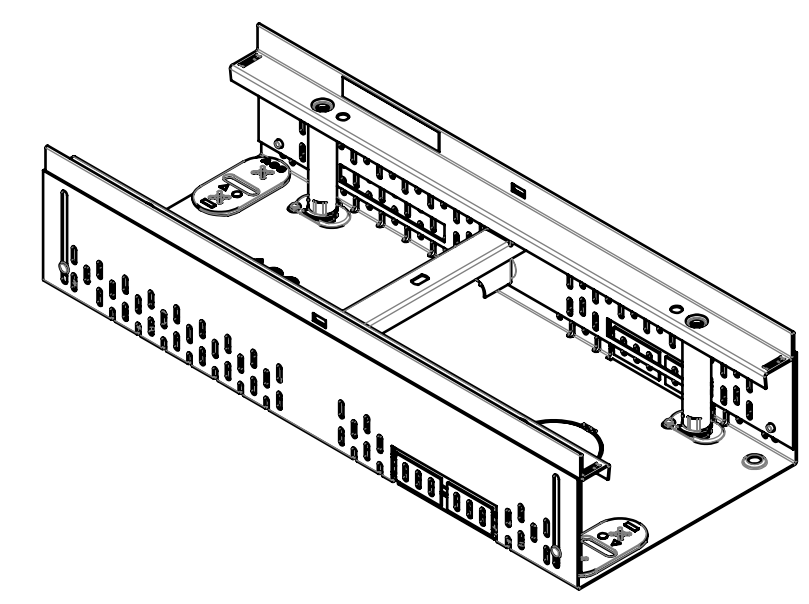

material number: 3006698

 ACO GmbH Am Ahlmannkai 24782 Büdelsdorf www.aco.com	drawing-no.: <b>1252530</b>	index: <b>002</b>	documenttype: marketing drw.
	created by:	reviewed by:	projection: ISO-E scale: 1:2

title:  
 ACO Profiline  
 ASM Channel for height adjustable 2.0 200x500mm, Type 3, galvanized steel  
 ZB Rinne für verstellbare Höhe 2.0 200x500mm Typ 3, verzinkter Stahl

serial-released

The reproduction, distribution and utilization of this document as well as the communication of its contents to others without express authorization is prohibited. Offenders will be held liable for the payment of damages. All rights reserved in the event of the grant of a patent, utility model or design. Observe copyright by ISO 16016

release date: 20.12.2023 sheet: 1/1

1 2 3 4 5 6 7 8 9 10 11 12

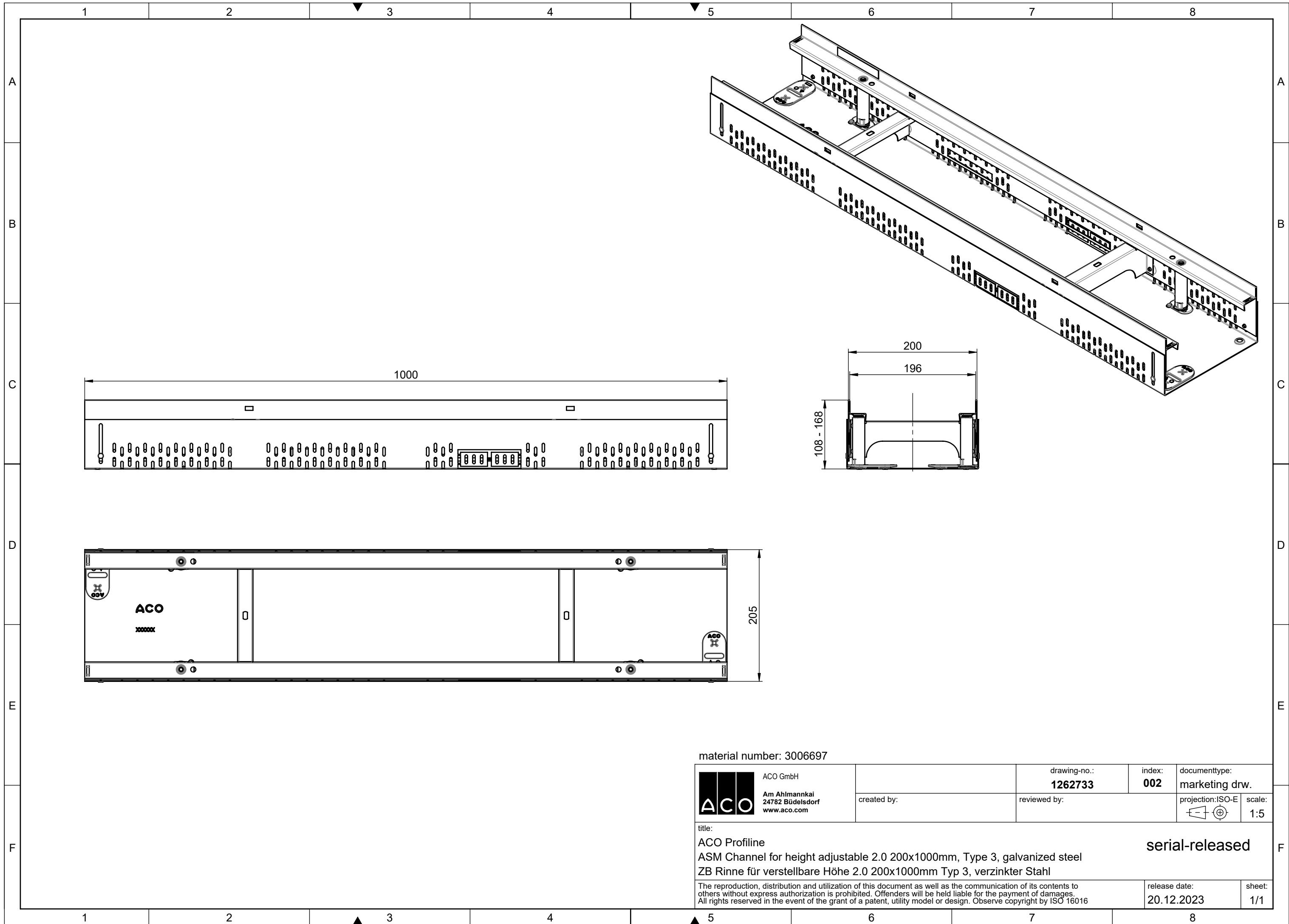

material number: 3006697

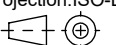
 ACO GmbH Am Ahlmannkai 24782 Büdelsdorf www.aco.com	drawing-no.: <b>1262733</b>	index: <b>002</b>	documenttype: marketing drw.
	created by:	reviewed by:	projection: ISO-E 
title: ACO Profiline ASM Channel for height adjustable 2.0 200x1000mm, Type 3, galvanized steel ZB Rinne für verstellbare Höhe 2.0 200x1000mm Typ 3, verzinkter Stahl			serial-released
<small>The reproduction, distribution and utilization of this document as well as the communication of its contents to others without express authorization is prohibited. Offenders will be held liable for the payment of damages. All rights reserved in the event of the grant of a patent, utility model or design. Observe copyright by ISO 16016</small>			release date: 20.12.2023
			sheet: 1/1

1 2 3 4 5 6 7 8 9 10 11 12

A  
B  
C  
D  
E  
F  
G  
H

SCALE 1 : 5

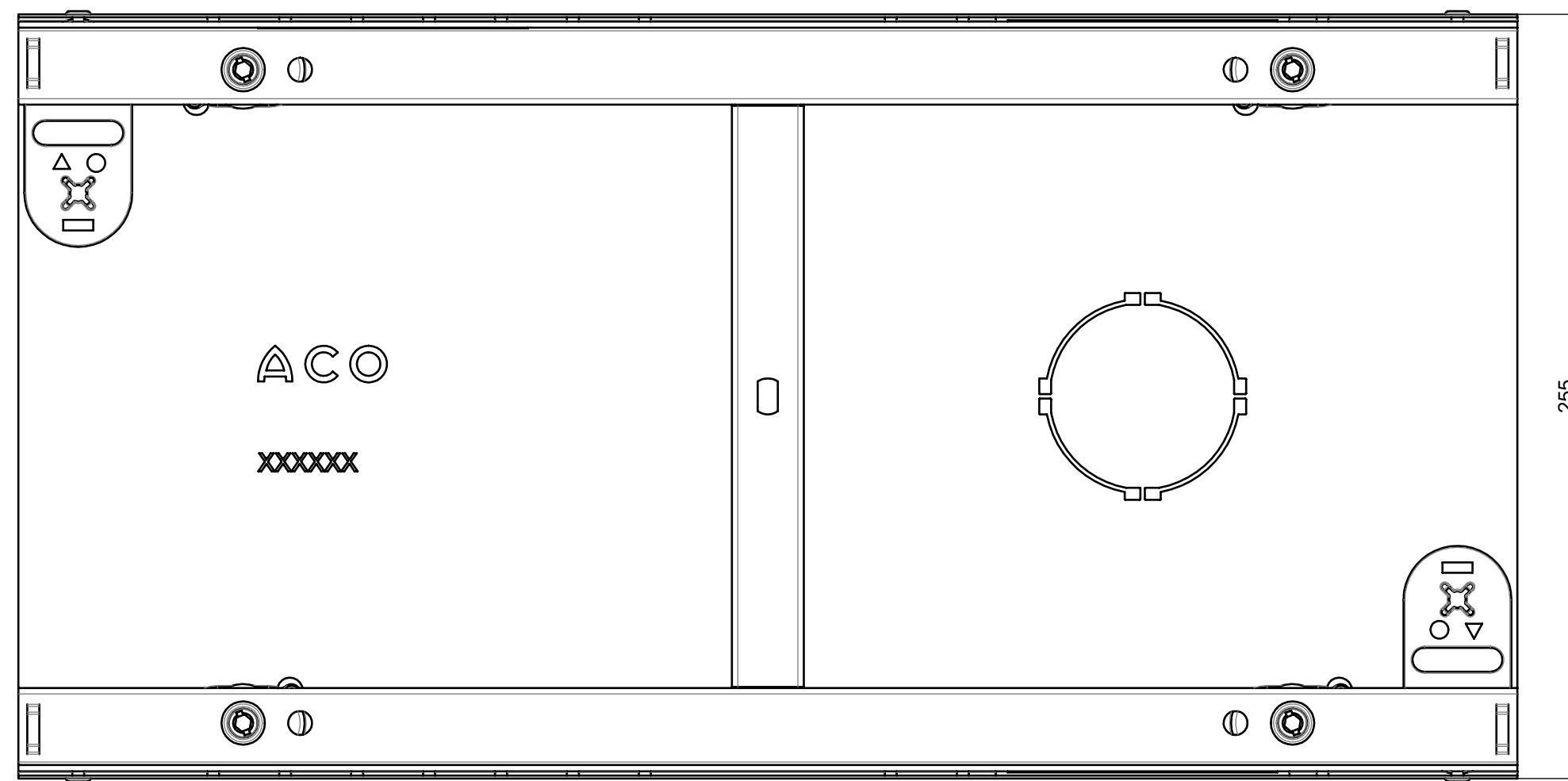
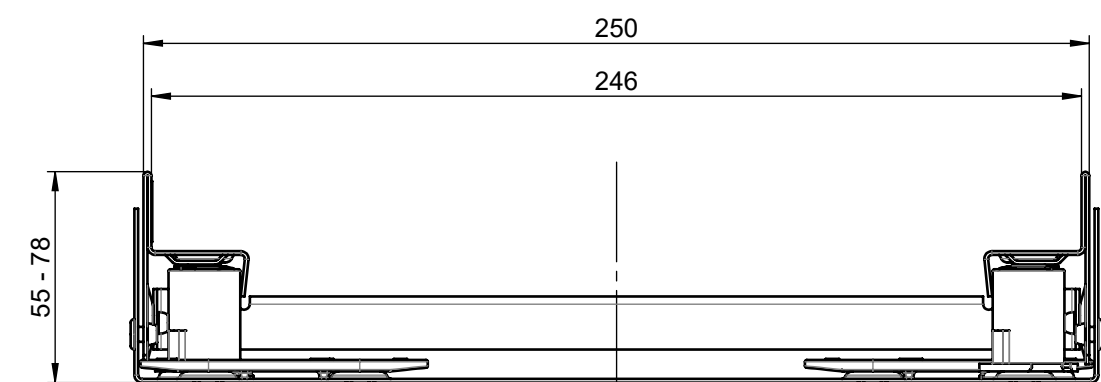
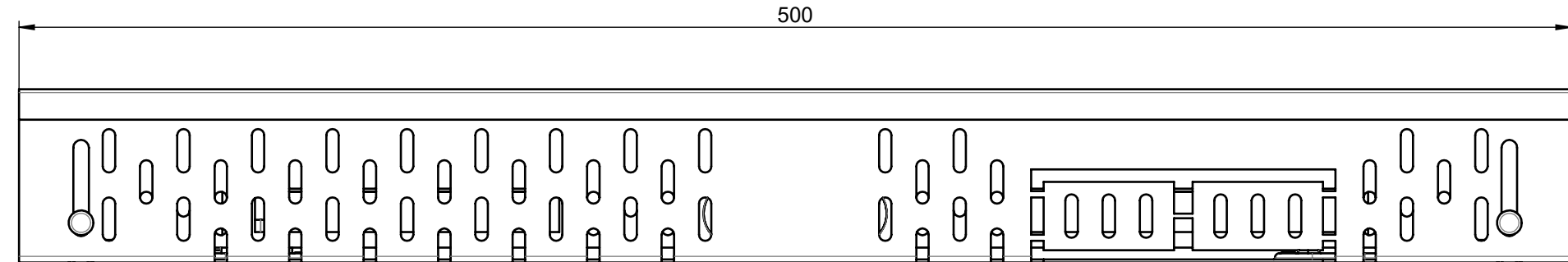
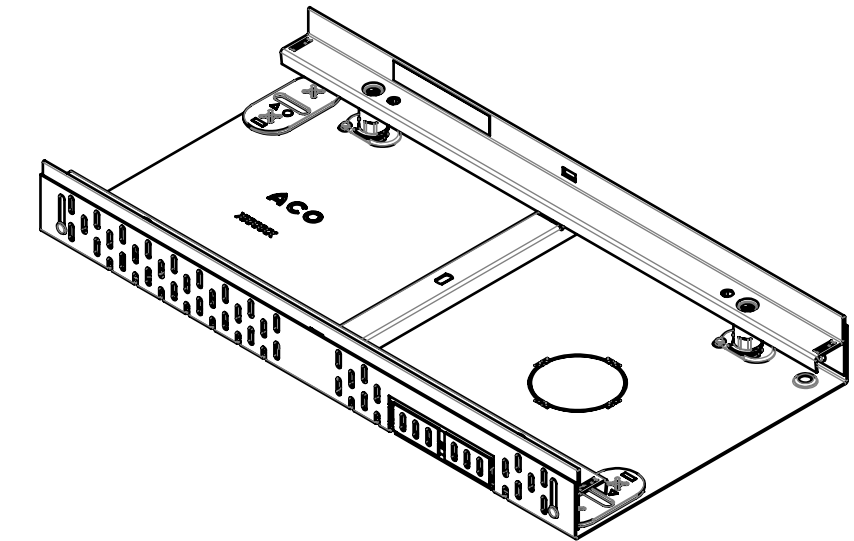

material number: 3006658

 ACO GmbH Am Ahlmannkai 24782 Büdelsdorf www.aco.com	drawing-no.: <b>1257457</b>	index: <b>002</b>	documenttype: marketing drw.
	created by:	reviewed by:	projection: ISO-E scale: 1:2

title:  
**ACO Profiline**  
 ASM Channel for height adjustable 2.0 250x500mm, Type 1, galvanized steel  
 ZB Rinne für verstellbare Höhe 2.0 250x500mm Typ 1, verzinkter Stahl

serial-released

The reproduction, distribution and utilization of this document as well as the communication of its contents to others without express authorization is prohibited. Offenders will be held liable for the payment of damages. All rights reserved in the event of the grant of a patent, utility model or design. Observe copyright by ISO 16016

release date:  
20.12.2023

sheet:  
1/1

1 2 3 4 5 6 7 8 9 10 11 12



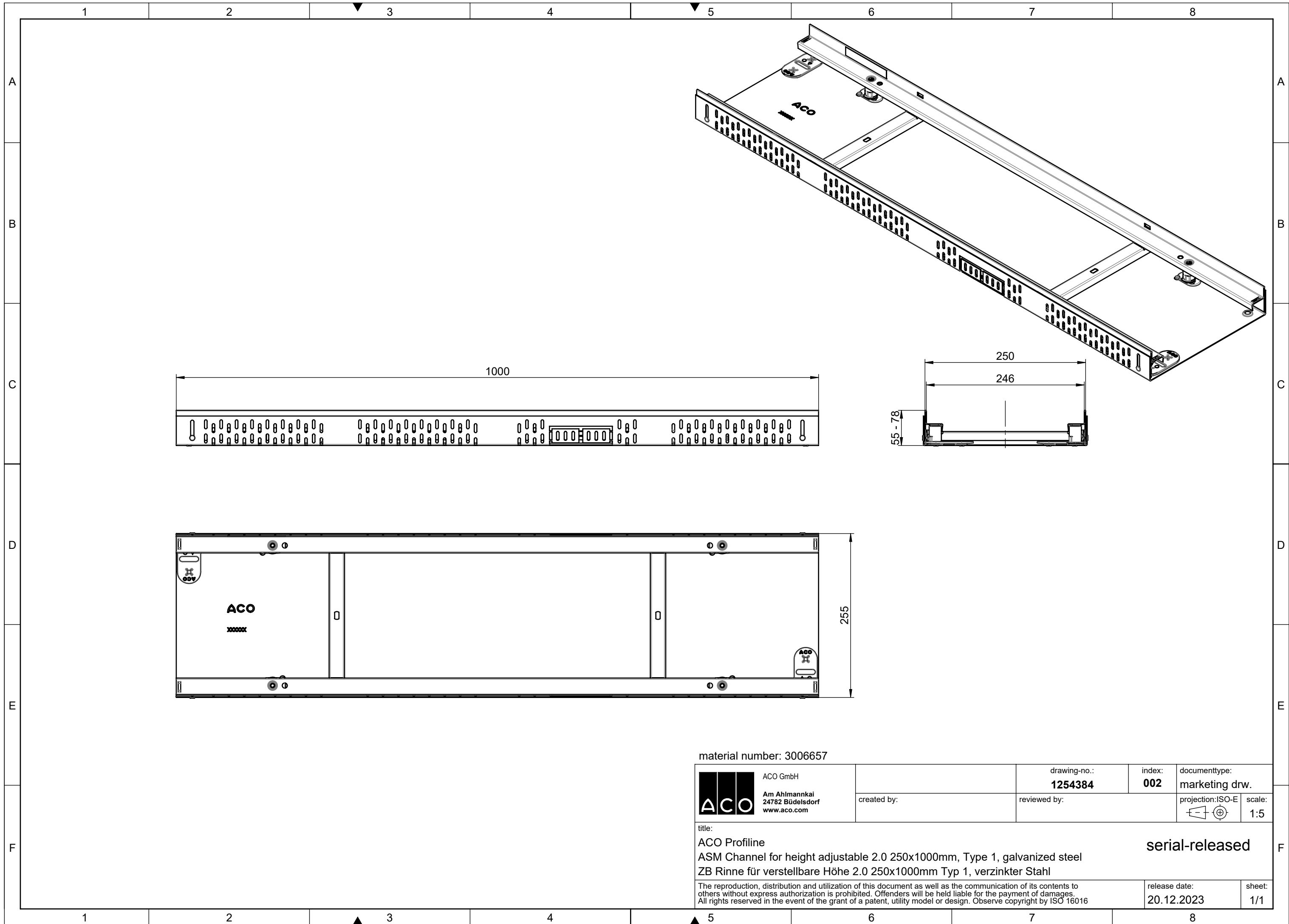

material number: 3006657

 ACO GmbH Am Ahlmannkai 24782 Büdelsdorf www.aco.com	drawing-no.: <b>1254384</b>	index: <b>002</b>	documenttype: marketing drw.
	created by:	reviewed by:	projection: ISO-E  scale: 1:5
title: ACO Profiline ASM Channel for height adjustable 2.0 250x1000mm, Type 1, galvanized steel ZB Rinne für verstellbare Höhe 2.0 250x1000mm Typ 1, verzinkter Stahl			serial-released
<small>The reproduction, distribution and utilization of this document as well as the communication of its contents to others without express authorization is prohibited. Offenders will be held liable for the payment of damages. All rights reserved in the event of the grant of a patent, utility model or design. Observe copyright by ISO 16016</small>			release date: <b>20.12.2023</b>
			sheet: <b>1/1</b>

S:\projekte\2019\001\_A3\_Vertrieb\22



1 2 3 4 5 6 7 8 9 10 11 12

A  
B  
C  
D  
E  
F  
G  
H

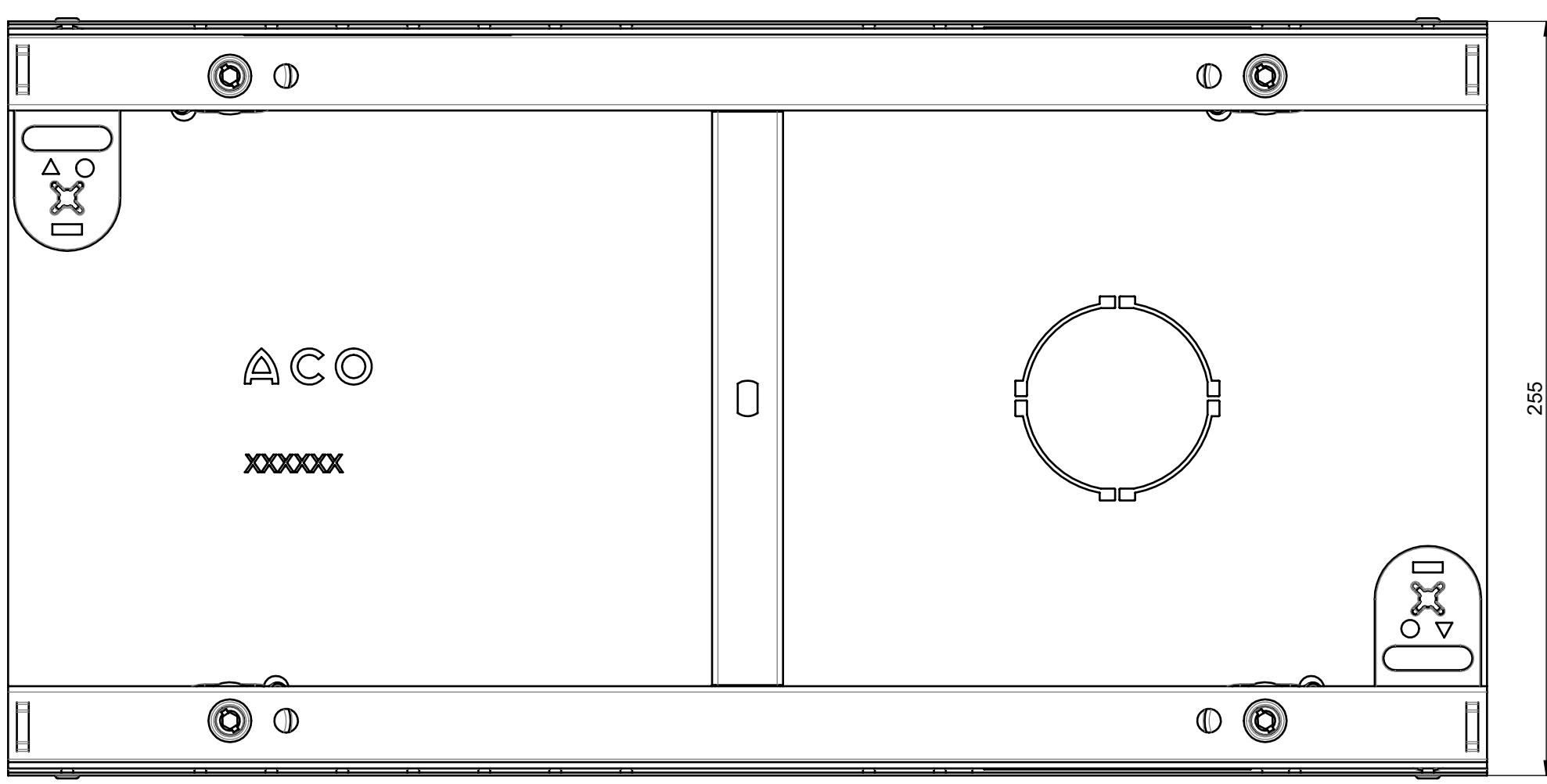
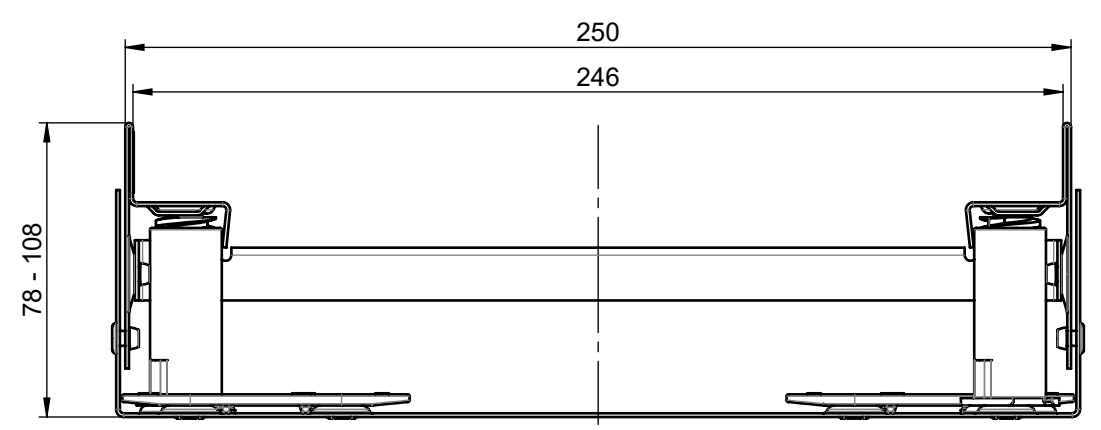
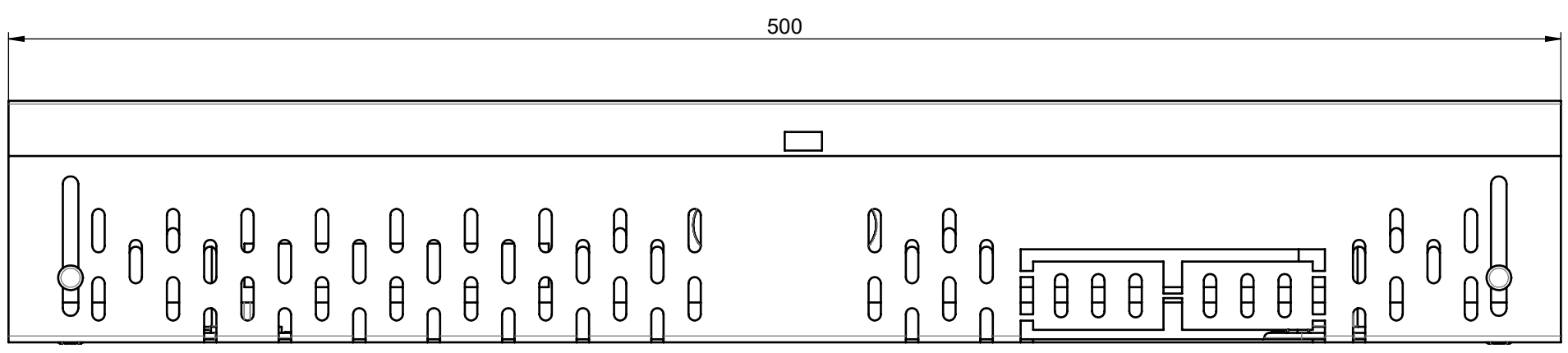
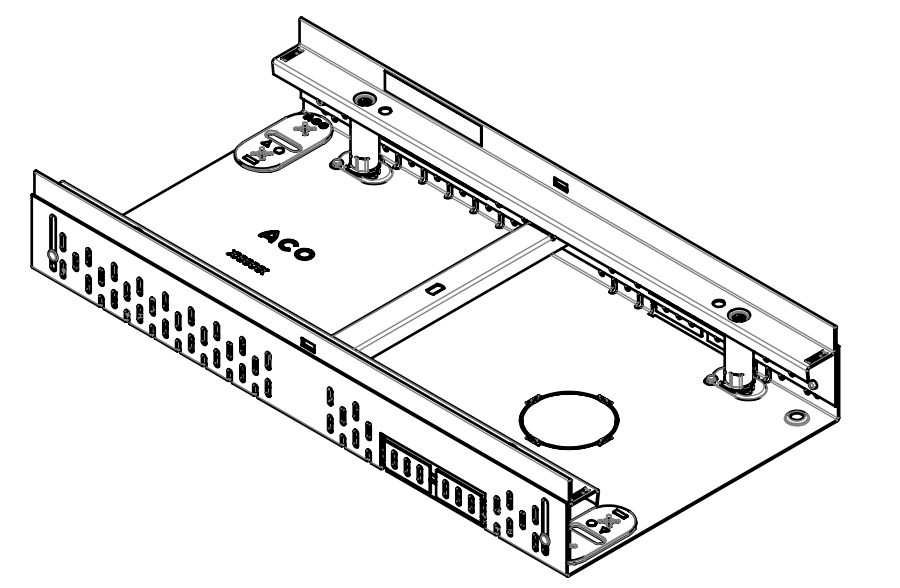
SCALE 1 : 5



material number: 3006662

 ACO GmbH Am Ahlmannkai 24782 Büdelsdorf www.aco.com	drawing-no.: <b>1250306</b>	index: <b>002</b>	documenttype: marketing drw.
	created by:	reviewed by:	projection: ISO-E 

title:  
 ACO Profiline  
 ASM Channel for height adjustable 2.0 250x500mm, Type 2, galvanized steel  
 ZB Rinne für verstellbare Höhe 2.0 250x500mm Typ 2, verzinkter Stahl

serial-released

The reproduction, distribution and utilization of this document as well as the communication of its contents to others without express authorization is prohibited. Offenders will be held liable for the payment of damages. All rights reserved in the event of the grant of a patent, utility model or design. Observe copyright by ISO 16016

release date:  
 20.12.2023

sheet:  
 1/1

1 2 3 4 5 6 7 8 9 10 11 12

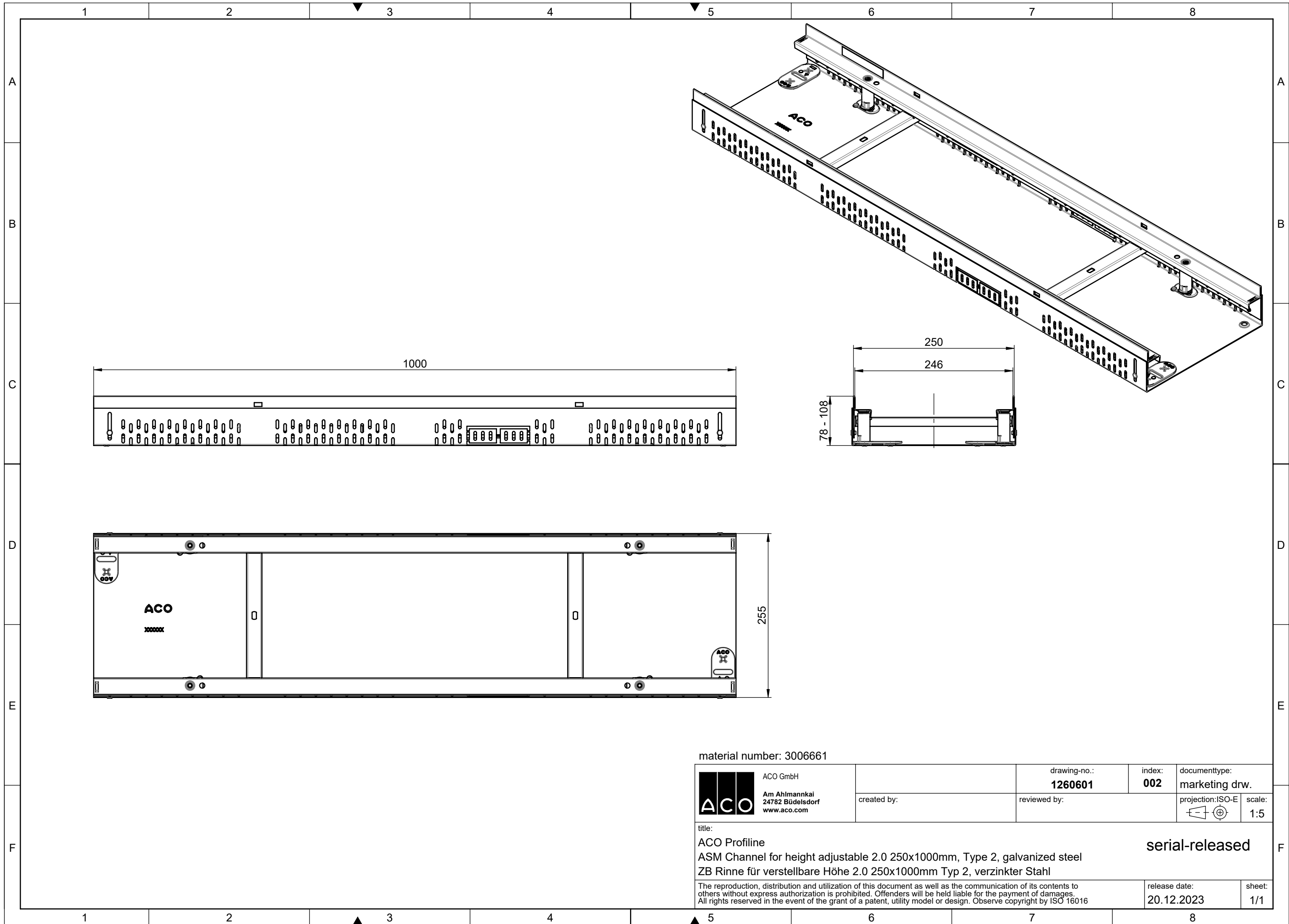

material number: 3006661

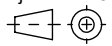
 ACO GmbH Am Ahlmannkai 24782 Büdelsdorf www.aco.com	drawing-no.: <b>1260601</b>	index: <b>002</b>	documenttype: marketing drw.
	created by:	reviewed by:	projection: ISO-E 
title: ACO Profiline ASM Channel for height adjustable 2.0 250x1000mm, Type 2, galvanized steel ZB Rinne für verstellbare Höhe 2.0 250x1000mm Typ 2, verzinkter Stahl			serial-released
<small>The reproduction, distribution and utilization of this document as well as the communication of its contents to others without express authorization is prohibited. Offenders will be held liable for the payment of damages. All rights reserved in the event of the grant of a patent, utility model or design. Observe copyright by ISO 16016</small>			release date: 20.12.2023
			sheet: 1/1

1 2 3 4 5 6 7 8 9 10 11 12

A  
B  
C  
D  
E  
F  
G  
H

SCALE 1 : 5

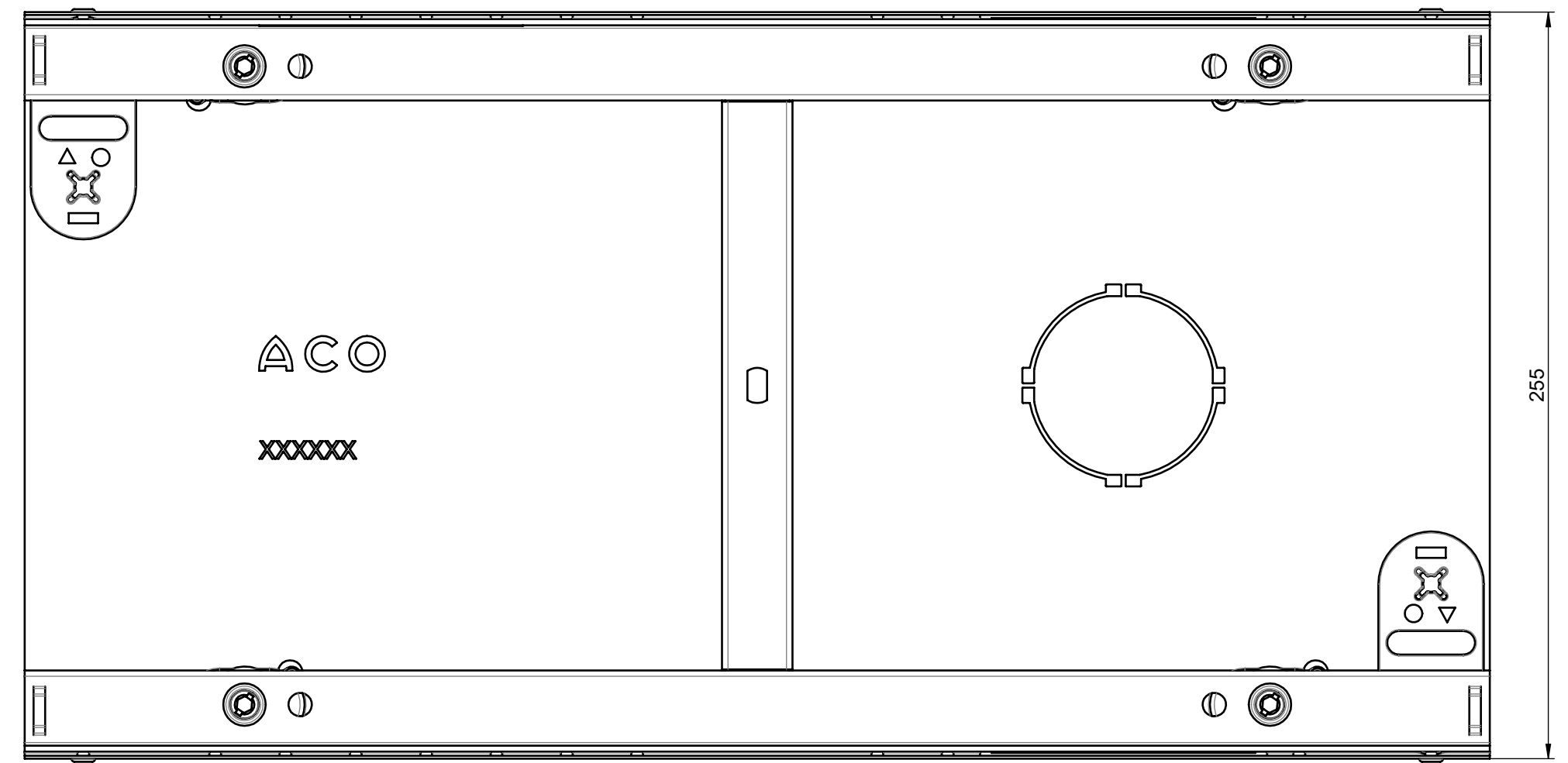
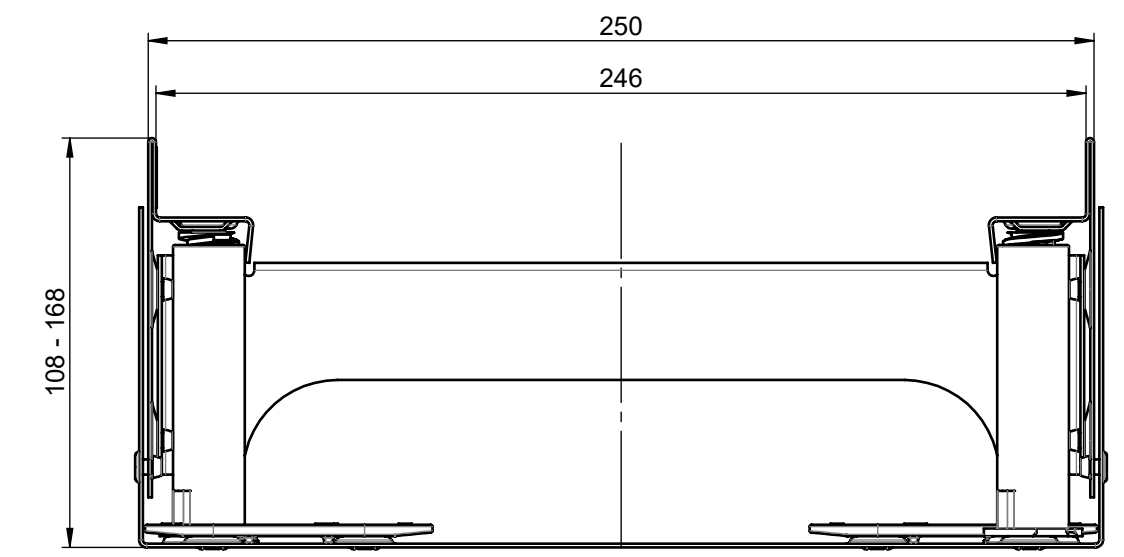
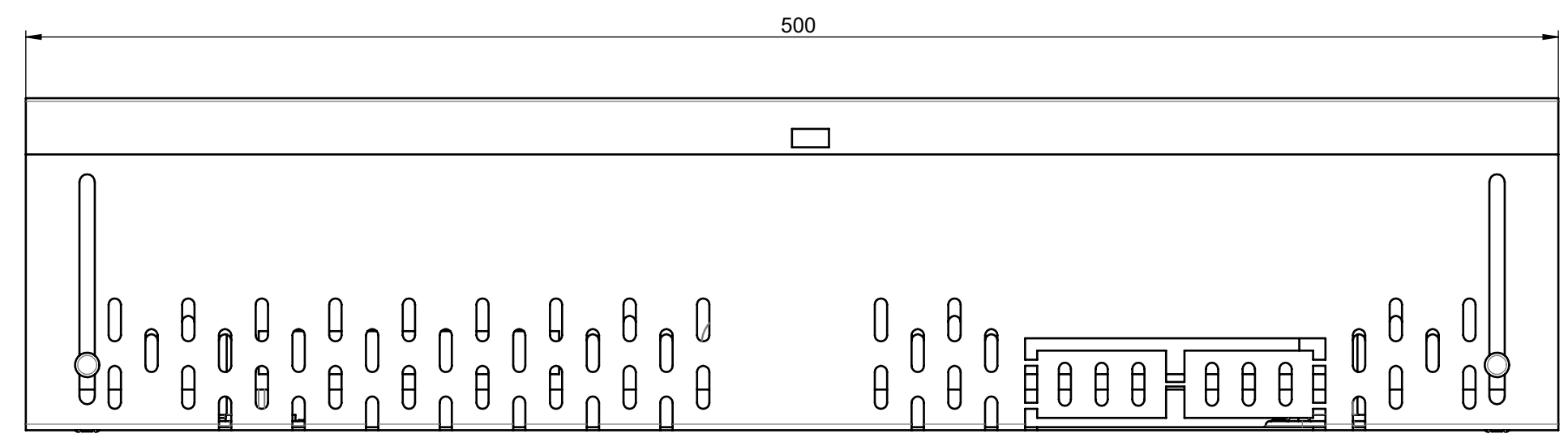
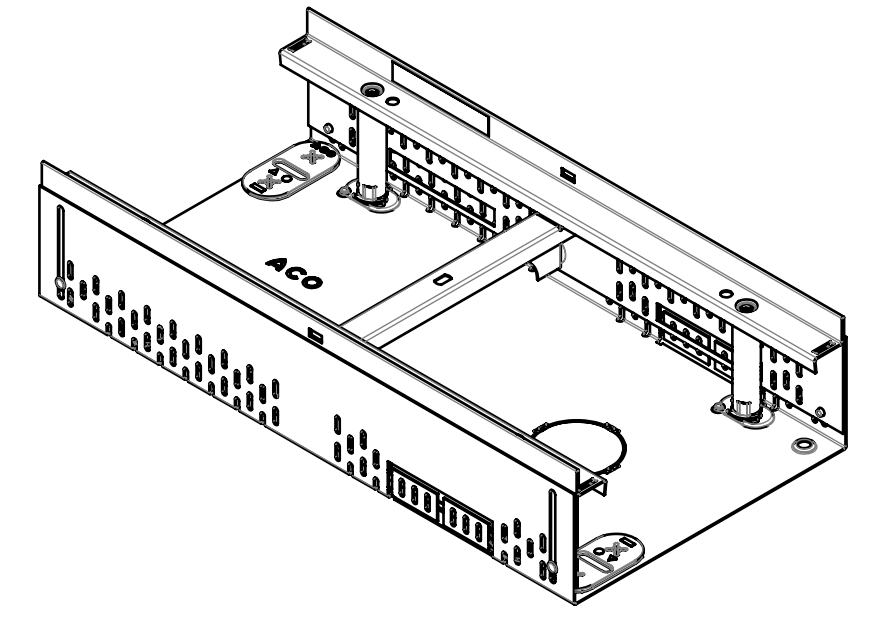

material number: 3006666

 ACO GmbH Am Ahlmannkai 24782 Büdelsdorf www.aco.com	drawing-no.: <b>1261863</b>	index: <b>002</b>	documenttype: marketing drw.
	created by:	reviewed by:	projection: ISO-E scale: 1:2

title:  
**ACO Profiline**  
 ASM Channel for height adjustable 2.0 250x500mm, Type 3, galvanized steel  
 ZB Rinne für verstellbare Höhe 2.0 250x500mm Typ 3, verzinkter Stahl

serial-released

The reproduction, distribution and utilization of this document as well as the communication of its contents to others without express authorization is prohibited. Offenders will be held liable for the payment of damages. All rights reserved in the event of the grant of a patent, utility model or design. Observe copyright by ISO 16016

release date:  
20.12.2023

sheet:  
1/1

1 2 3 4 5 6 7 8 9 10 11 12

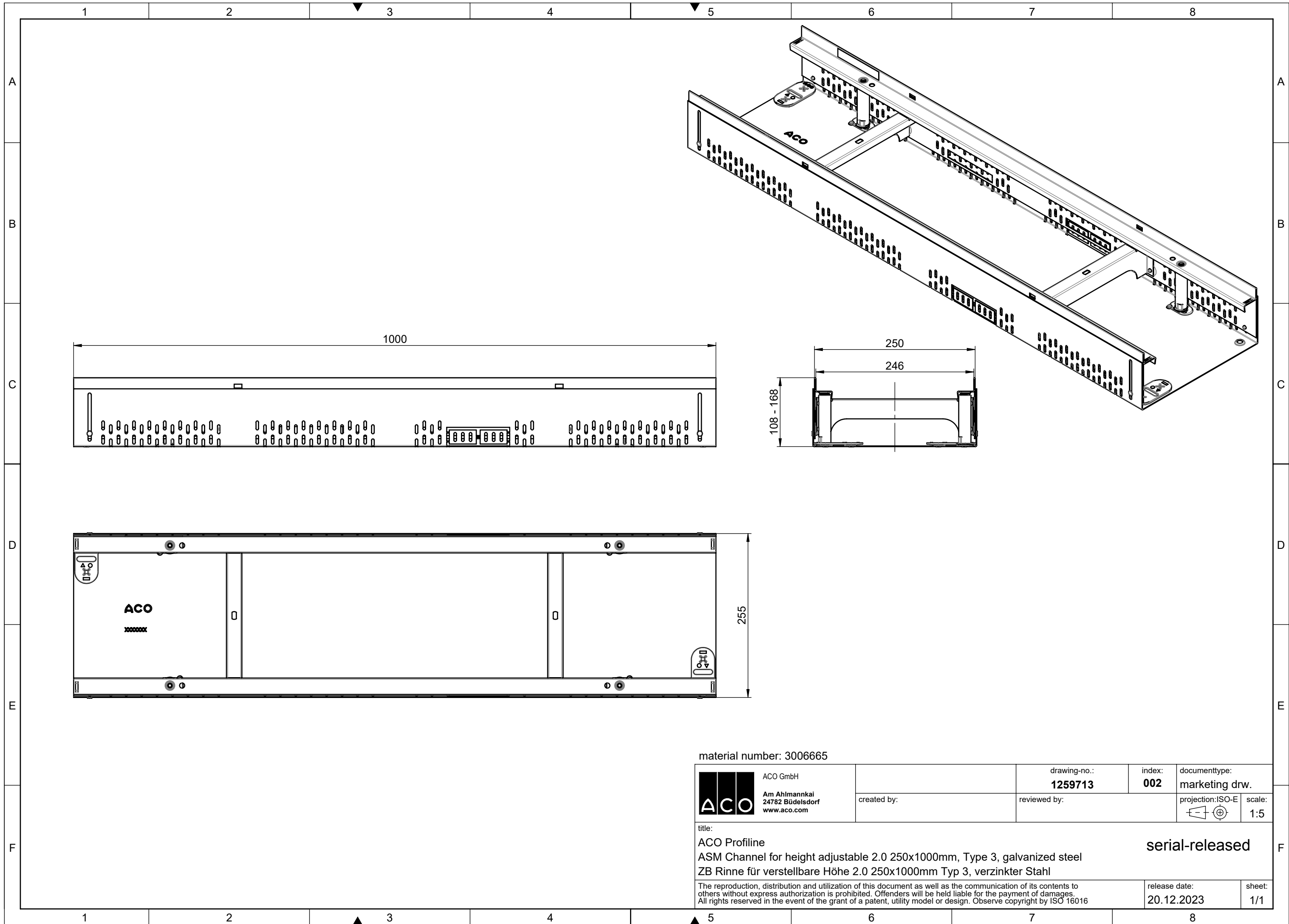

material number: 3006665

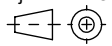
 ACO GmbH Am Ahlmannkai 24782 Büdelsdorf www.aco.com	drawing-no.: <b>1259713</b>	index: <b>002</b>	documenttype: marketing drw.
	created by:	reviewed by:	projection: ISO-E  scale: 1:5
title: ACO Proflin ASM Channel for height adjustable 2.0 250x1000mm, Type 3, galvanized steel ZB Rinne für verstellbare Höhe 2.0 250x1000mm Typ 3, verzinkter Stahl			serial-released
The reproduction, distribution and utilization of this document as well as the communication of its contents to others without express authorization is prohibited. Offenders will be held liable for the payment of damages. All rights reserved in the event of the grant of a patent, utility model or design. Observe copyright by ISO 16016			release date: 20.12.2023
			sheet: 1/1

S:\projekte\2019\001\_A3\_Vertrieb\22