

Technische Daten

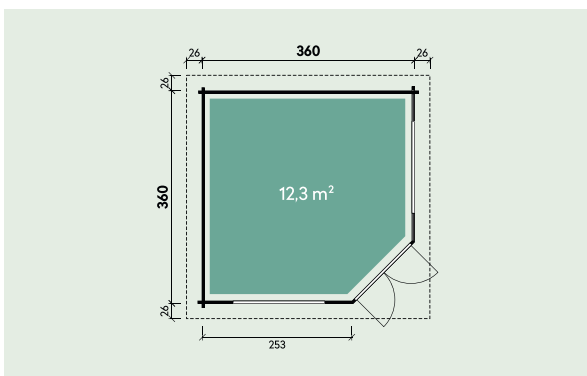

Artikelnummer:

544 120





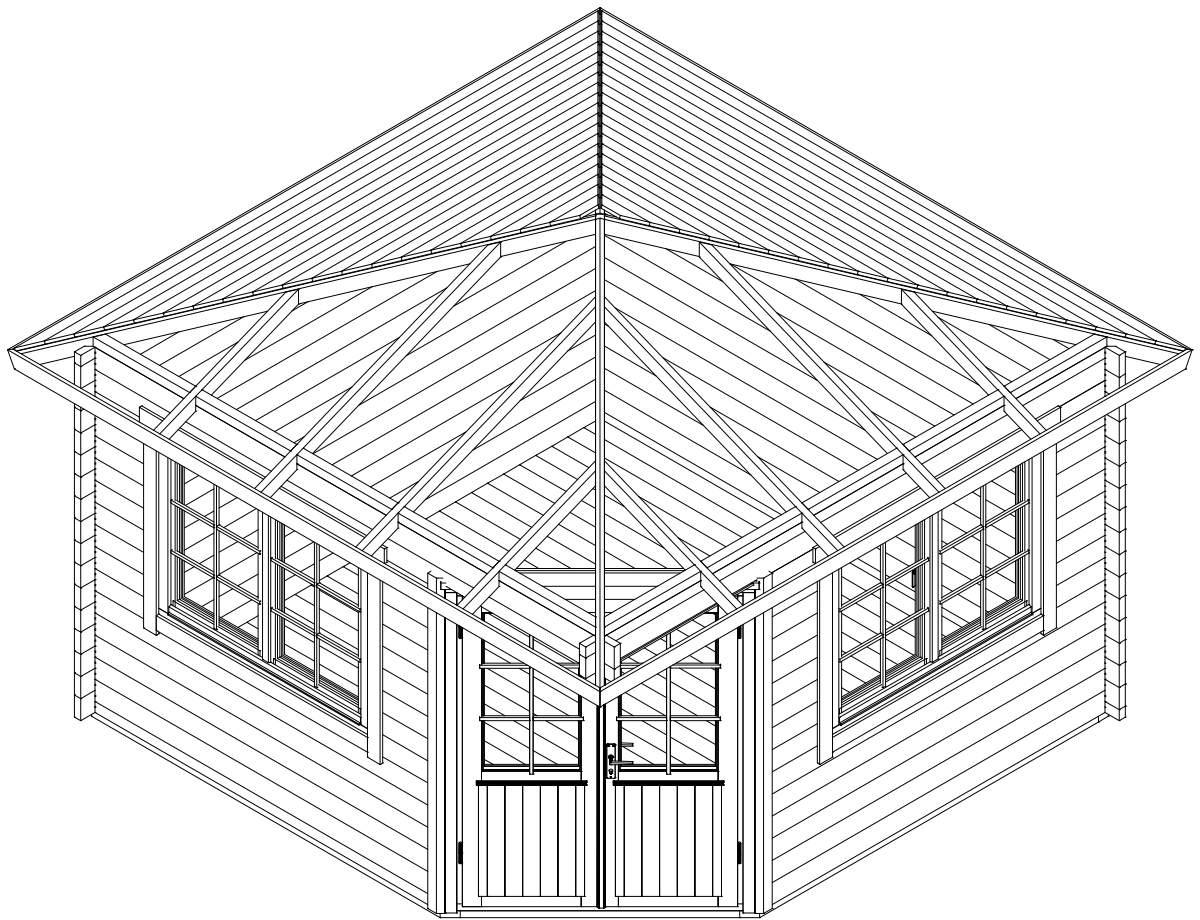

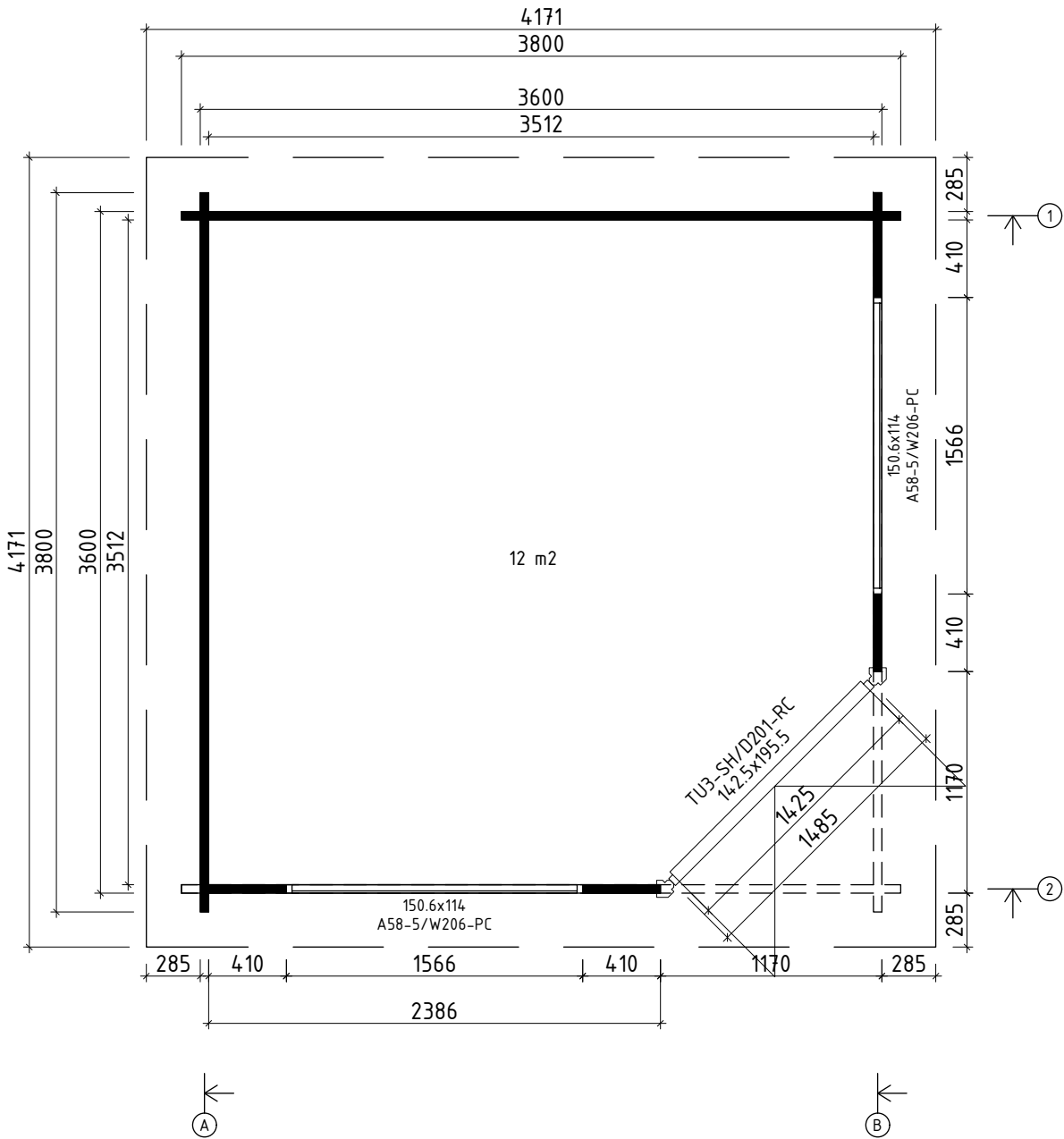



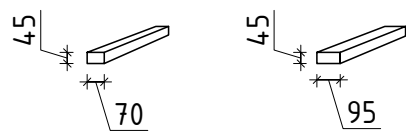
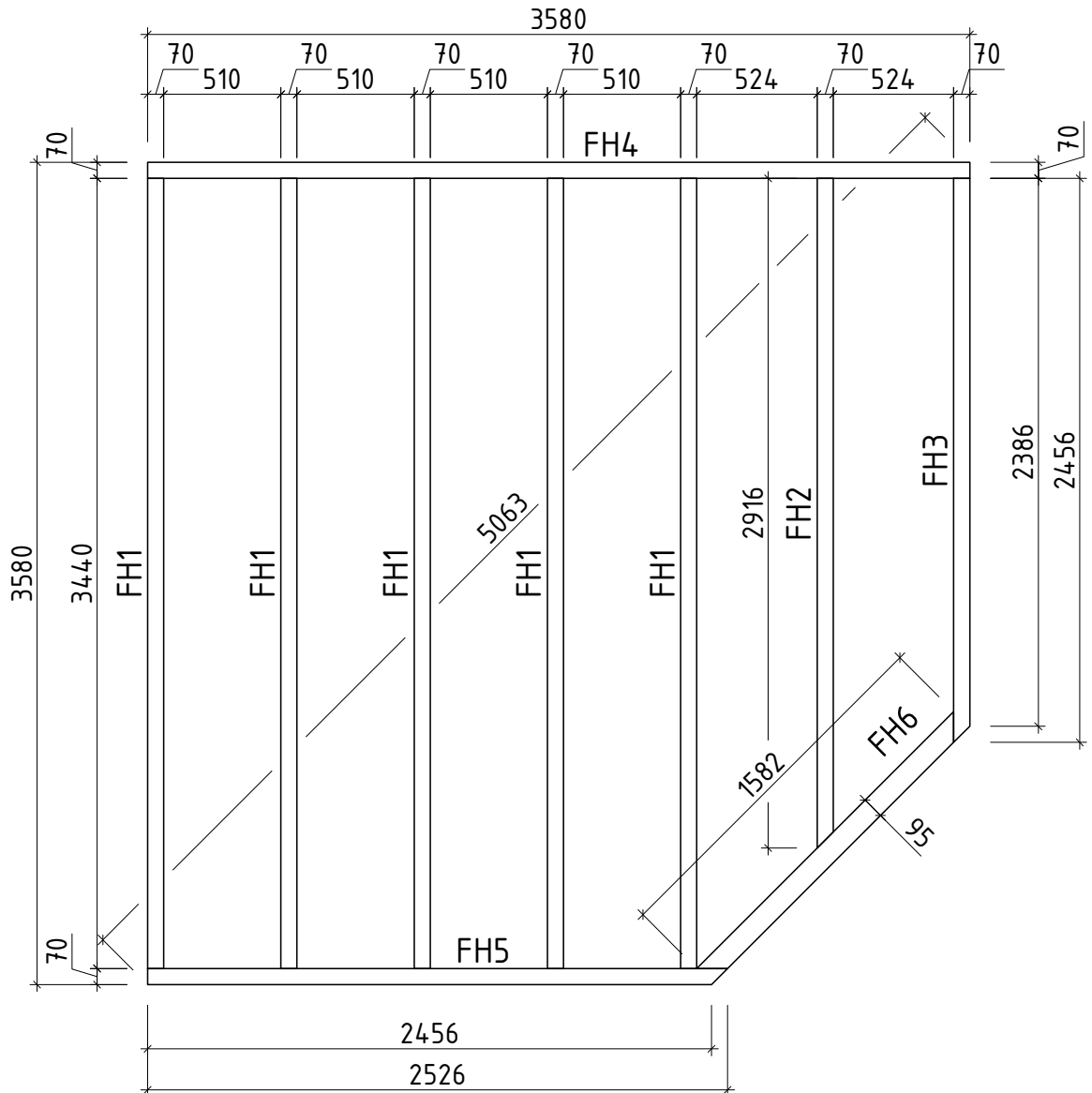

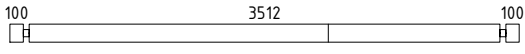
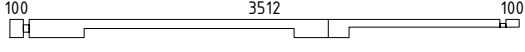
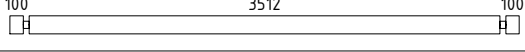
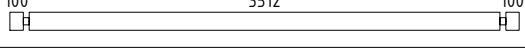
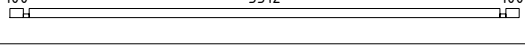
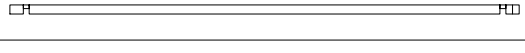
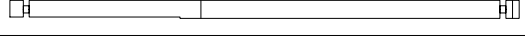
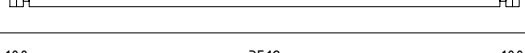
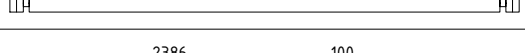
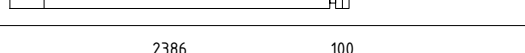
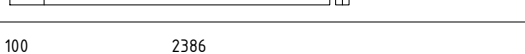
Kontrolliert durch:

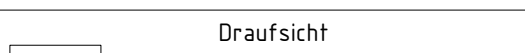





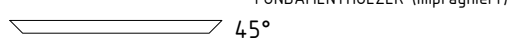
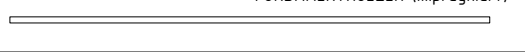
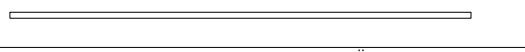
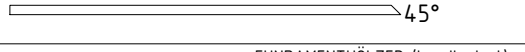





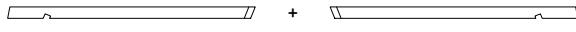

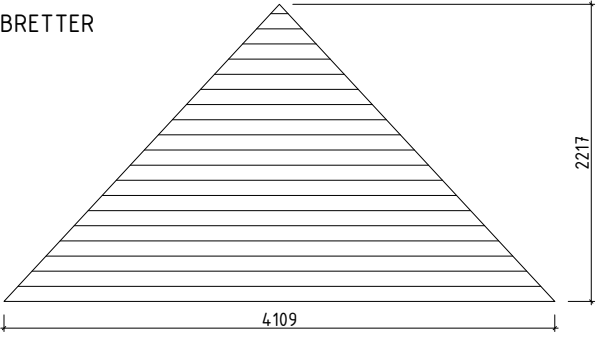
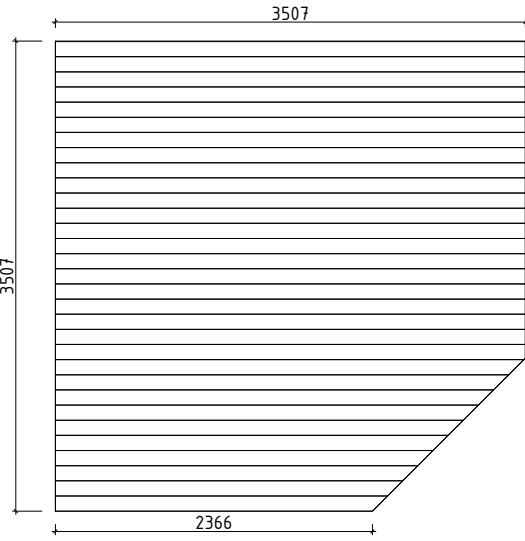

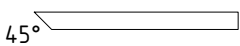



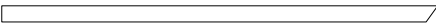

Wir empfehlen als Fundament für Ihr Gartenhaus eine vollflächig festgegründete, gepflasterte oder betonierte Fläche. Wahlweise ist auch ein Punkt- oder Streifenfundament möglich.



Pos		Stck	Profil (mm)	Länge (mm)
001		1	44x135	3800
002		1	44x135	3800
003		1	44x135	3800
004		15	44x135	3800
005		1	44x68	3800
006		1	44x68	3800
007		1	44x135	3800
008		1	44x68	3800
009		16	44x135	3800
010		1	44x135	2530
011		5	44x135	2530
012		1	44x135	2530
013		5	44x135	2530
014		1	44x68	2530
015		✓ 4+4	44x74	679
016		12	44x74	668
017		9	44x135	554
018		8	44x135	554
019		13	44x135	410
020		4	44x135	410
FH6		1	95x45	1582
FH4		1	70x45	3580
FH1		5	70x45	3440
FH2		1	70x45	2916
FH5		1	70x45	2526

Pos		Stck	Profil (mm)	Länge (mm)
FH3	FUNDAMENTHÖLZER (imprägniert) 	1	70x45	2456
GSP1	GRATSPARREN 	4	44x94	3013
SFT1	SCHIFTER 	4+4	44x85	1847
SFT2	SCHIFTER 	4+4	44x85	1080
ZE-1	ZENTRALE VERBINDUNGSELEMENT (DACH) 	1	44x44	90
	DACHBRETTER 	4	113x18	
	FUSSBODENBRETTER 		113x18	21+1 ohne Ecke 11 mit Ecke
	FUSSBODENLEISTEN 	✓	18x40	14,0 lfdm
DzT 40-1	ECKTÜR- Deckbrett zum Tür 40 	1	18x40	1585
VK1-1	ECKTÜR- Verkleidungsleisten 58 für Vordachelement 	2	58x18	1110
P9L2-1	ECKTÜR- linke Türpfoste 44 	1	90x90	2045
P9R2-1	ECKTÜR- rechte Türpfoste 44 	1	90x90	2045
VE1	ECKTÜR- Vordachelement 1435x745 	1		

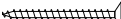
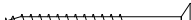
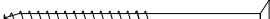
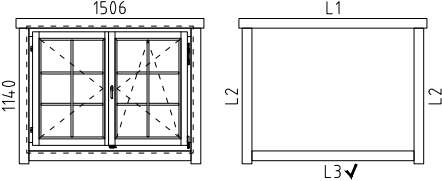
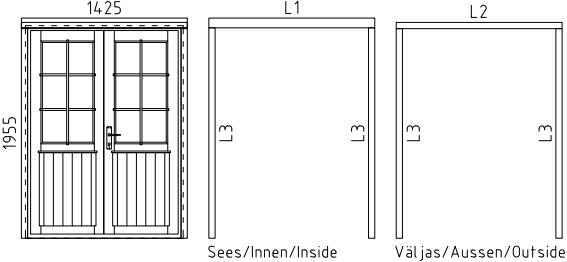
Pos		Stck	Profil (mm)	Länge (mm)
T02-1	TRAUFENBRETT 18x120 	4	18x120	4210
SH	Schlaghölzer 	3		
ML1	Metallstange 	4	D10	1170
KL1	Gewindestange M8 	3		2000
KL2	Gewindestange M8 	3		258
	Mutter M8 U-Scheibe Ø25 	6		
	Befestigungsmutter M8 	3		
NG04	NÄGEL 2.5x50 Dachbretter Fussbodenbretter 	1208		
SR32	SCHRAUBEN 3.0x30 Fussbodenleiste 	28		
SR37	SCHRAUBEN 3.5x45 Deckbrett, Vordachelement Verkleidungsleisten, Traufenbretter Fenster- und Türleisten 	130		
SR55	SCHRAUBEN 5.0x70 Gratsparren GSP1, Schifter SFT1, SFT2 pos 011 und 014 (1. Bohlenreihe neben die Tür) 	24		
SR57	SCHRAUBEN 5.0x100 Fundamenthölzer Wandbalken pos 015, 016, 002 und 006 Gratsparren GSP1, Schifter SFT1, SFT2 	107		
	FENSTER <u>Q4</u>  W4-D44P-06C-15061140 A58-5/W206-PC L1 18x90 L=1745mm 2x L2 18x90 L=1260mm 4x L3 18x90 L=1505mm 2x ✓	2		
	TÜR <u>Q4</u>  D4-M44R-56C-14251955 TU3-SH/D201-RC L1 18x90 L=1540mm 1x L2 18x58 L=1540mm 1x L3 18x58 L=1955mm 4x ✓ DIN rechts Sees/Innen/Inside Väljas/Aussen/Outside	1		
	✓ - bitte selber anpassen (falls nötig!)			

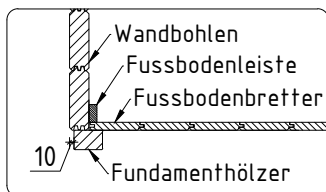
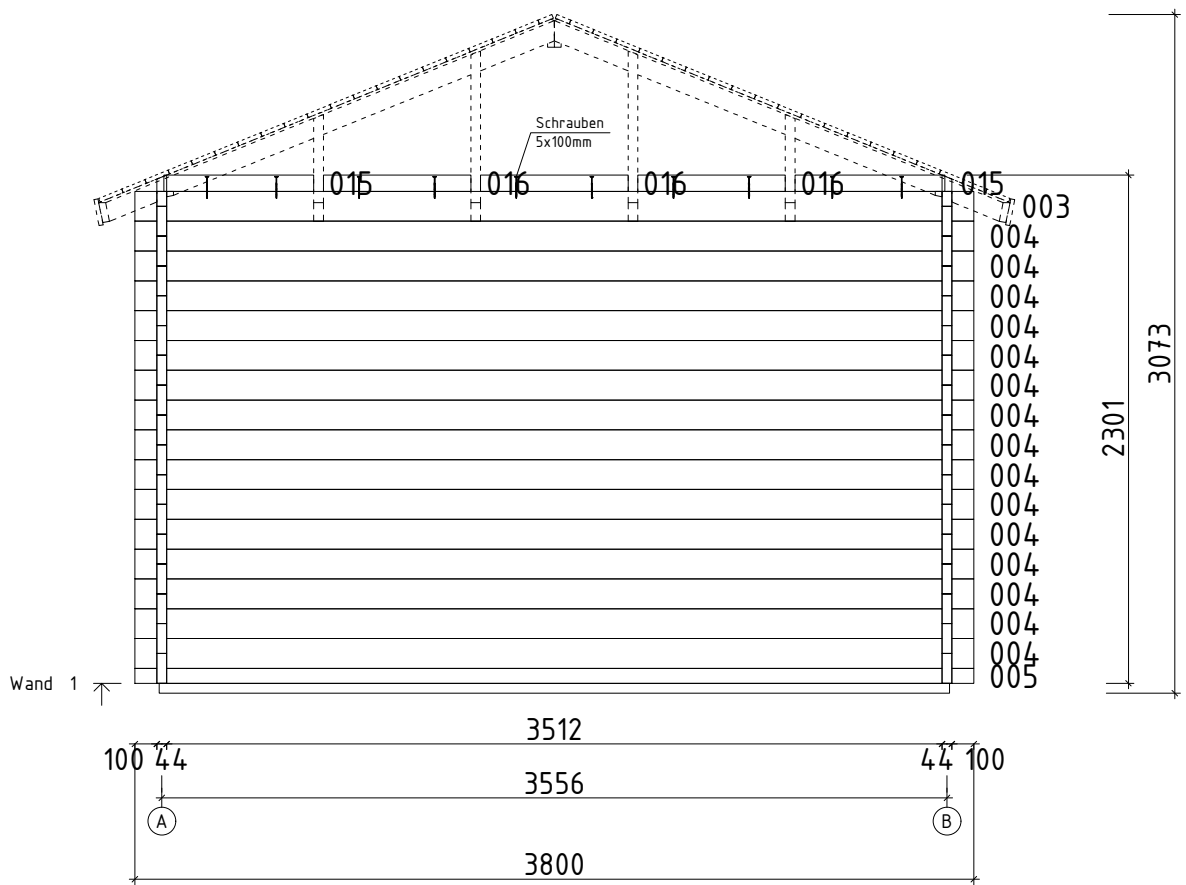

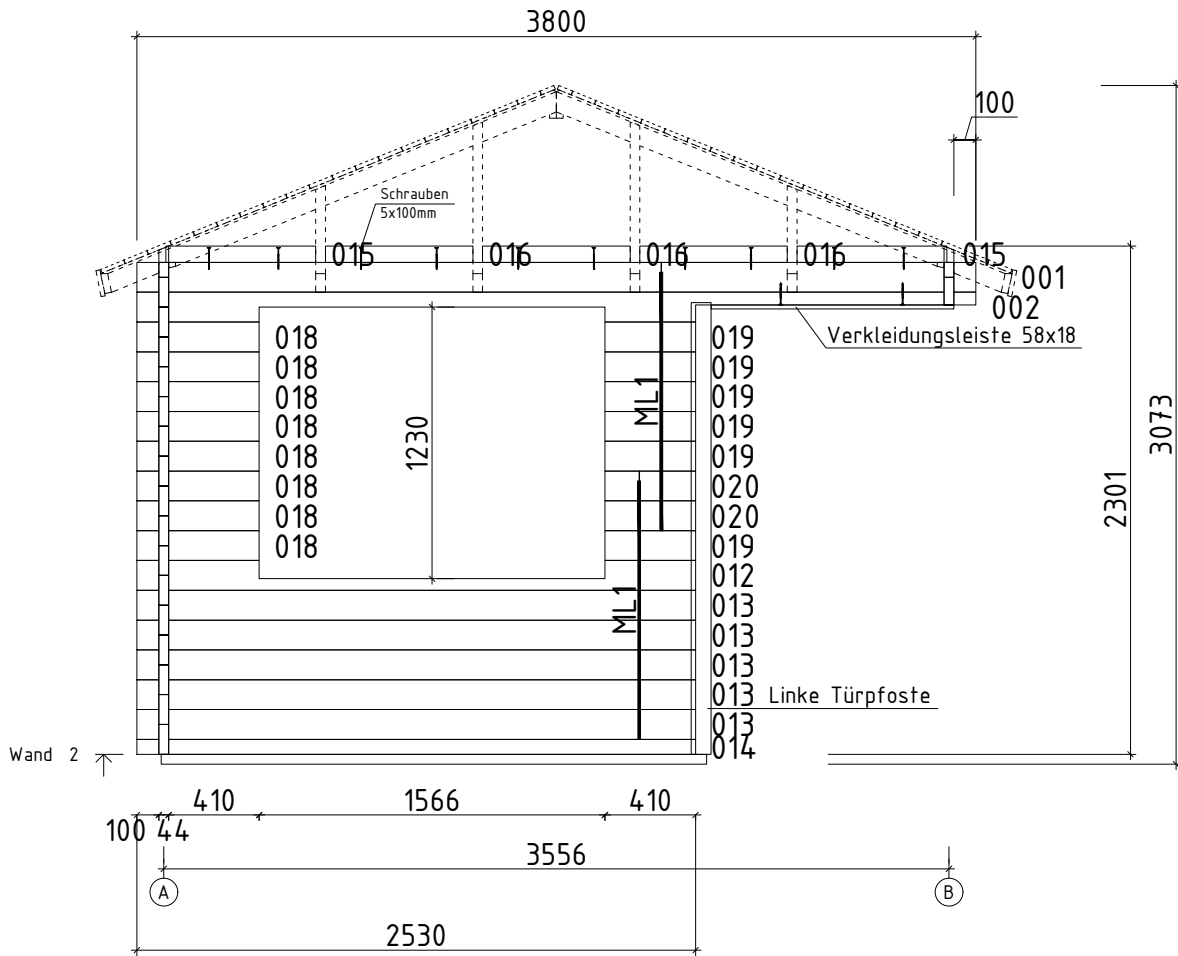

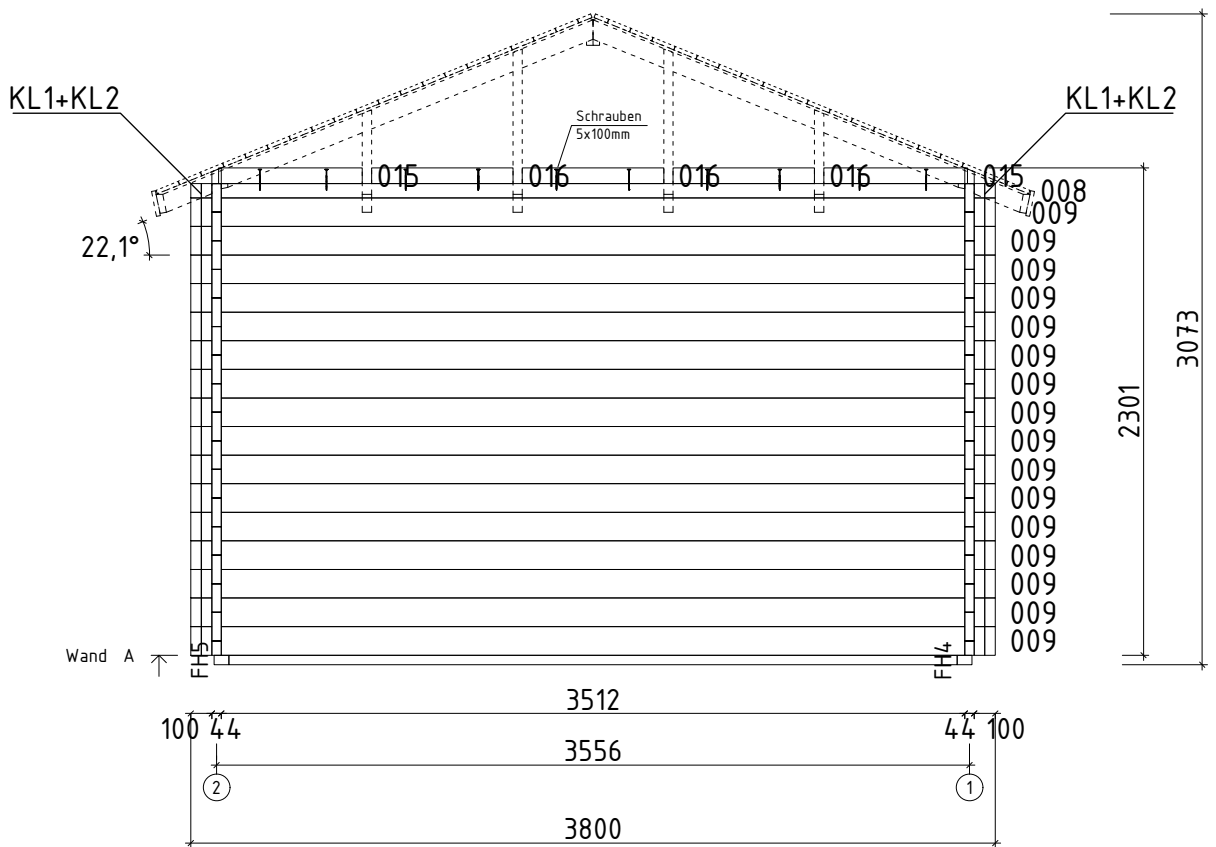

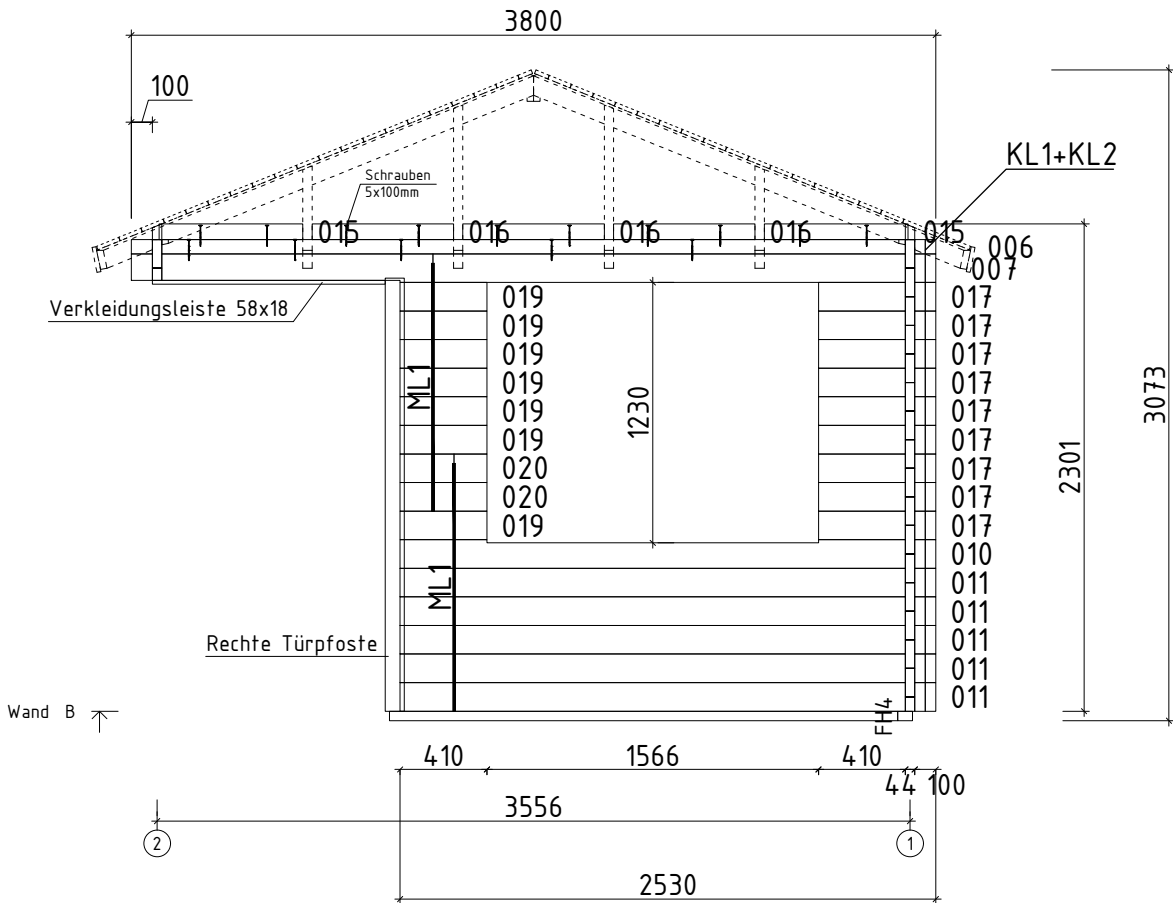

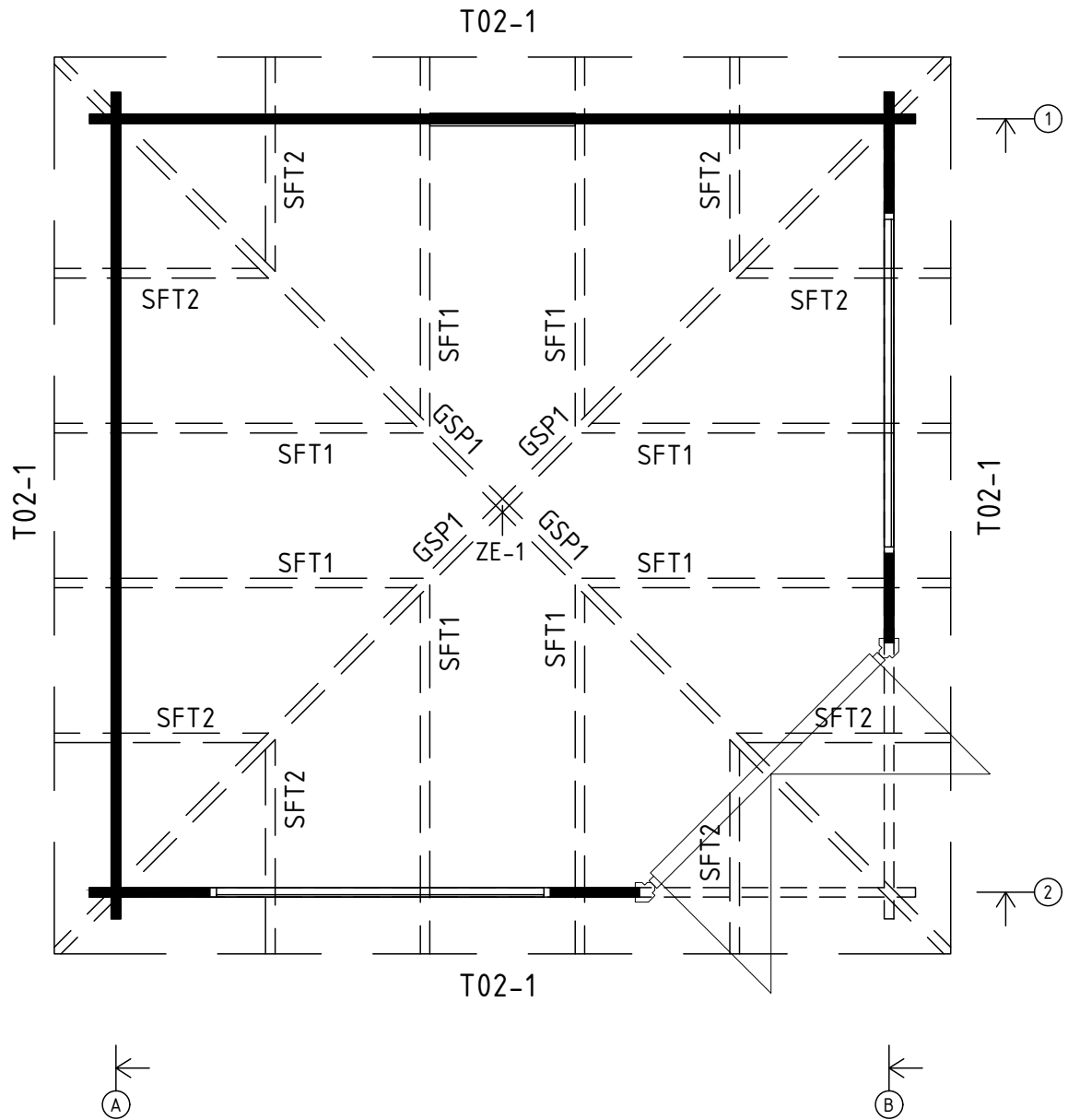

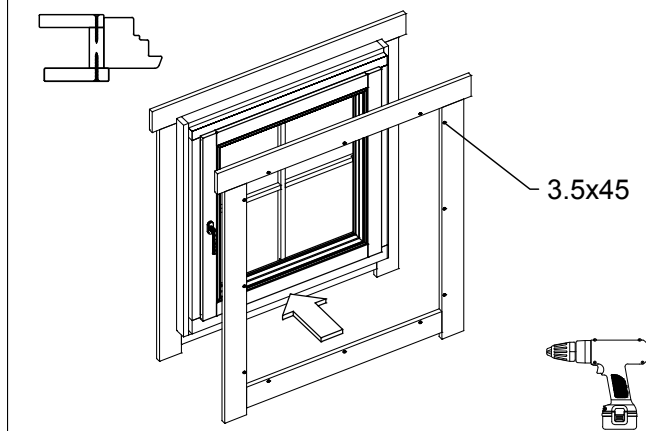
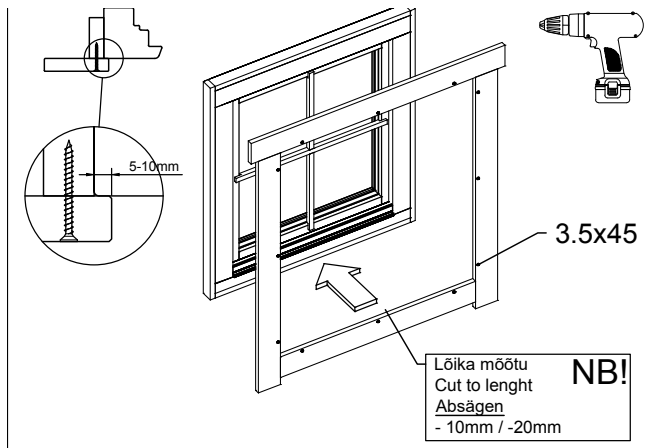
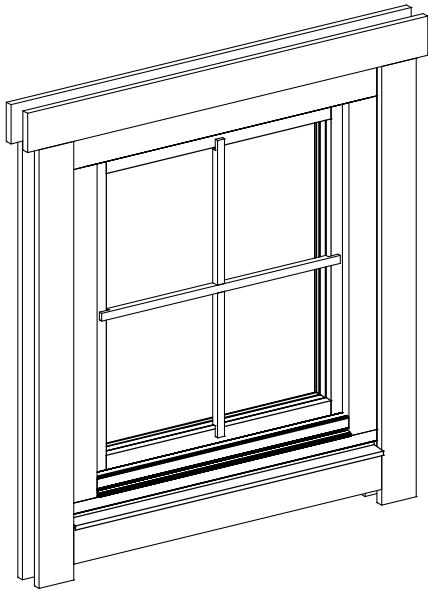

Q4

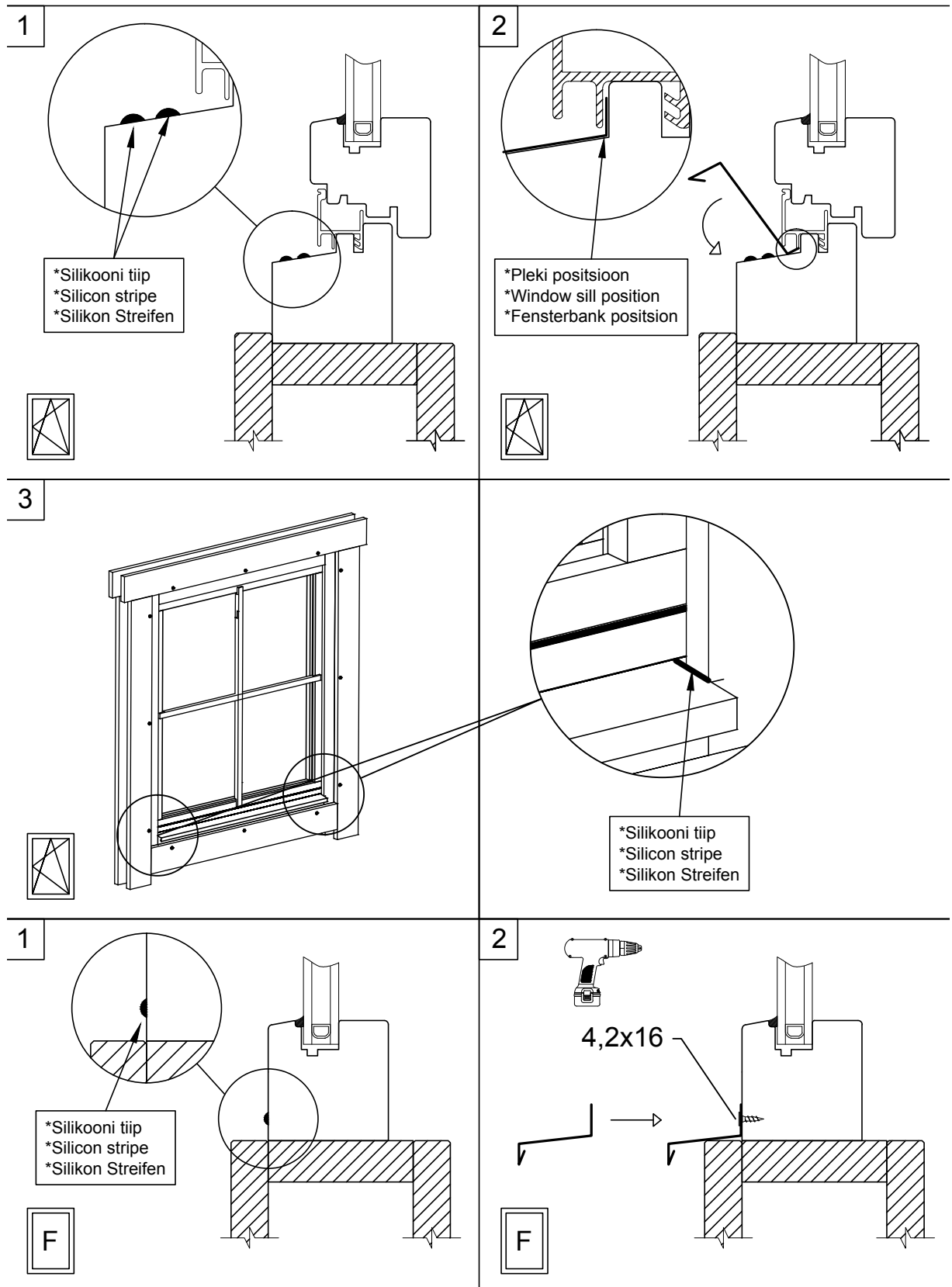

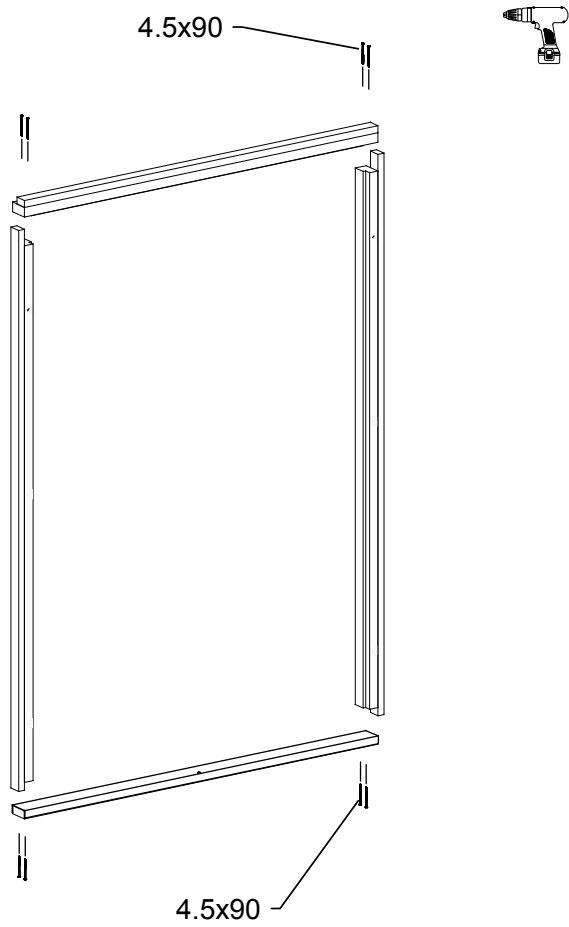
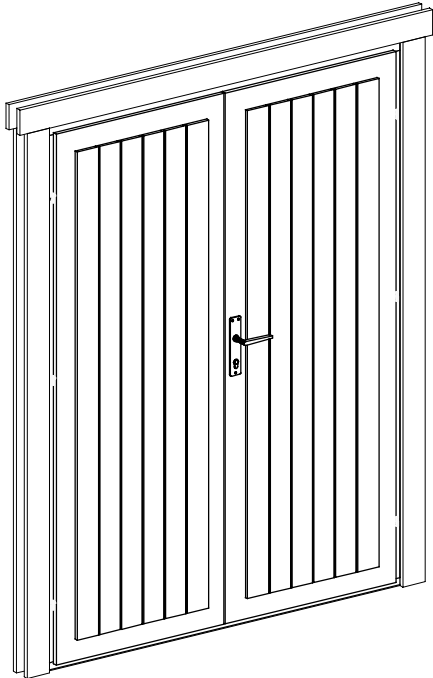

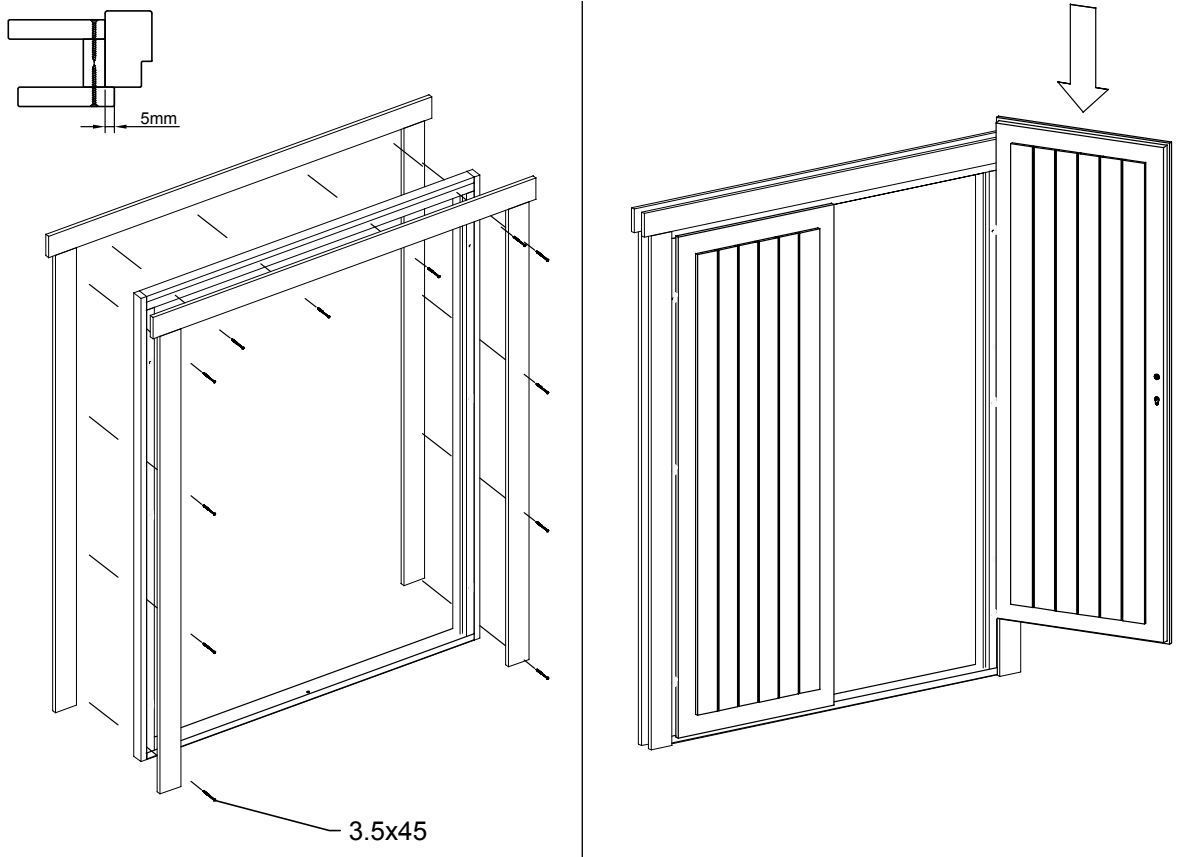

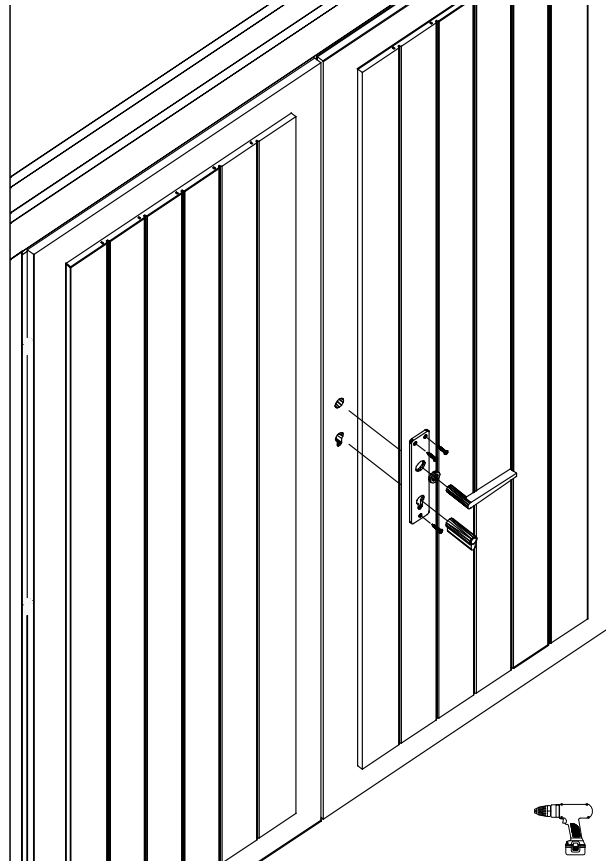
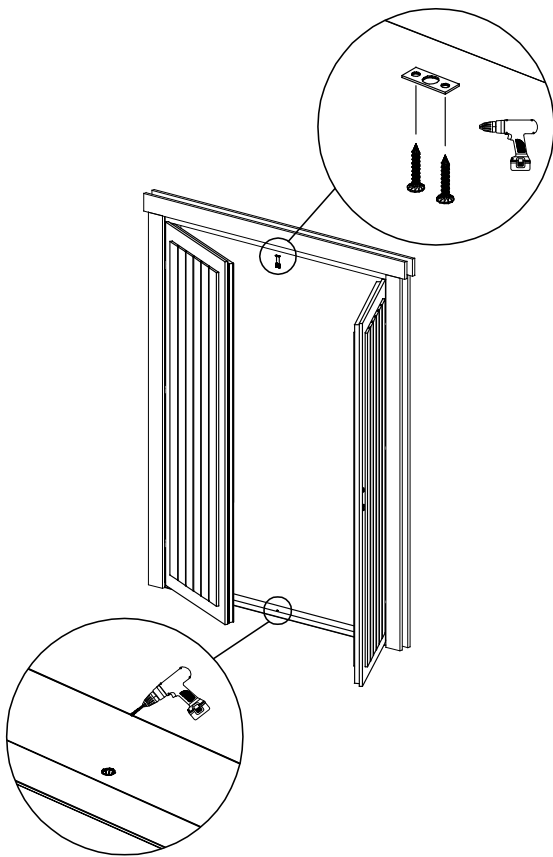

Step 1: Dachelement an den Wänden verschrauben.
Step 1: Screw canopy element to the wall.

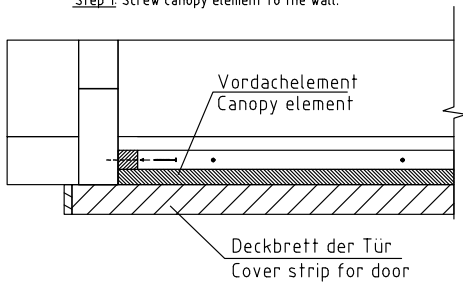

Step 2: Das Deckbrett muss von oben (durch das VD-Element) an das Dachelement verschraubt werden.
Step 2: Fasten cover strip to the canopy element.

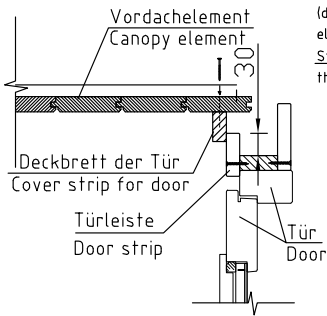

Step 3: Die Verkleidungsleisten in die richtige Länge schneiden und unter das VD-Element befestigen.
Step 3: Cut trim strips to size and fasten under the canopy element.

