

Mehr Produkte finden Sie  
in unserem Katalog!

Art. 870 170



# Nordkap 70-C

70 mm / 390x390 cm / 15,2 m<sup>2</sup>



## DIMENSIONEN

	Bohlenstärke	70 mm
	Innenmaß	376x376 cm
	Sockelmaß	390x390 cm
	Gesamtmaß	450x530 cm
	Grundfläche	15,2 m <sup>2</sup>
	Rauminhalt	32,6 m <sup>3</sup>
	Firsthöhe	254 cm
	Seitenwandhöhe	208 cm
	Dachüberstand vorne/seitlich/hinten	120/25/20 cm

## DACH

	Dachneigung	15°
	Dachfläche	24,0 m <sup>2</sup>
	Dachbretter	20 mm



## TÜR/ FENSTER

	Doppeltür (Isoverglast)	144,8x186,5 cm
	Doppelfenster (1 Stück, isolierverglast, <b>Einhand-Dreh-/Kipp</b> )	117x89,5 cm
	Einzelfenster (1 Stück, isolierverglast, <b>Einhand-Dreh-/Kipp</b> )	62,5x81,6 cm

## FUSSBODEN

	Fußbodenbretter	28 mm
--	-----------------	-------

## VERPACKUNG

	Paketabmessung	663x117x80 cm
	Paketgewicht	1.950 kg

## ZUBEHÖR (zzgl.)

	6 Rollen Dachpappe zu 6 m Dachschindel-Set Nr. 11 Dachrinne Kunststoff 322B mit KS-Ergän- zungsset K4B, anthrazit Kupfer bis 550 cm Alu bis 600 cm mit 2 Fallrohren Terrasse 70.2 asymmetrisch
--	---

5 JAHRE  
GARANTIE



## Grundriss

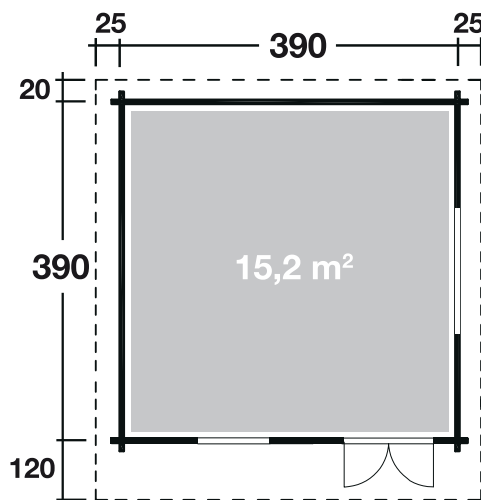

Weitere Informationen finden Sie unter: [www.finnhaus.de](http://www.finnhaus.de) oder im aktuellen Katalog.  
Technische Änderungen, Druckfehler und Irrtümer vorbehalten.