

Lisa 44-B

Wandaußenmaß: 360 x 360 cm

Bohlenstärke: 44 mm



Vom Kunden farblich behandelt.

Kontrolliert durch:

Achtung: Alle angegebenen Maße sind ca.-Maße!

3D-Darstellung Lisa 44-B

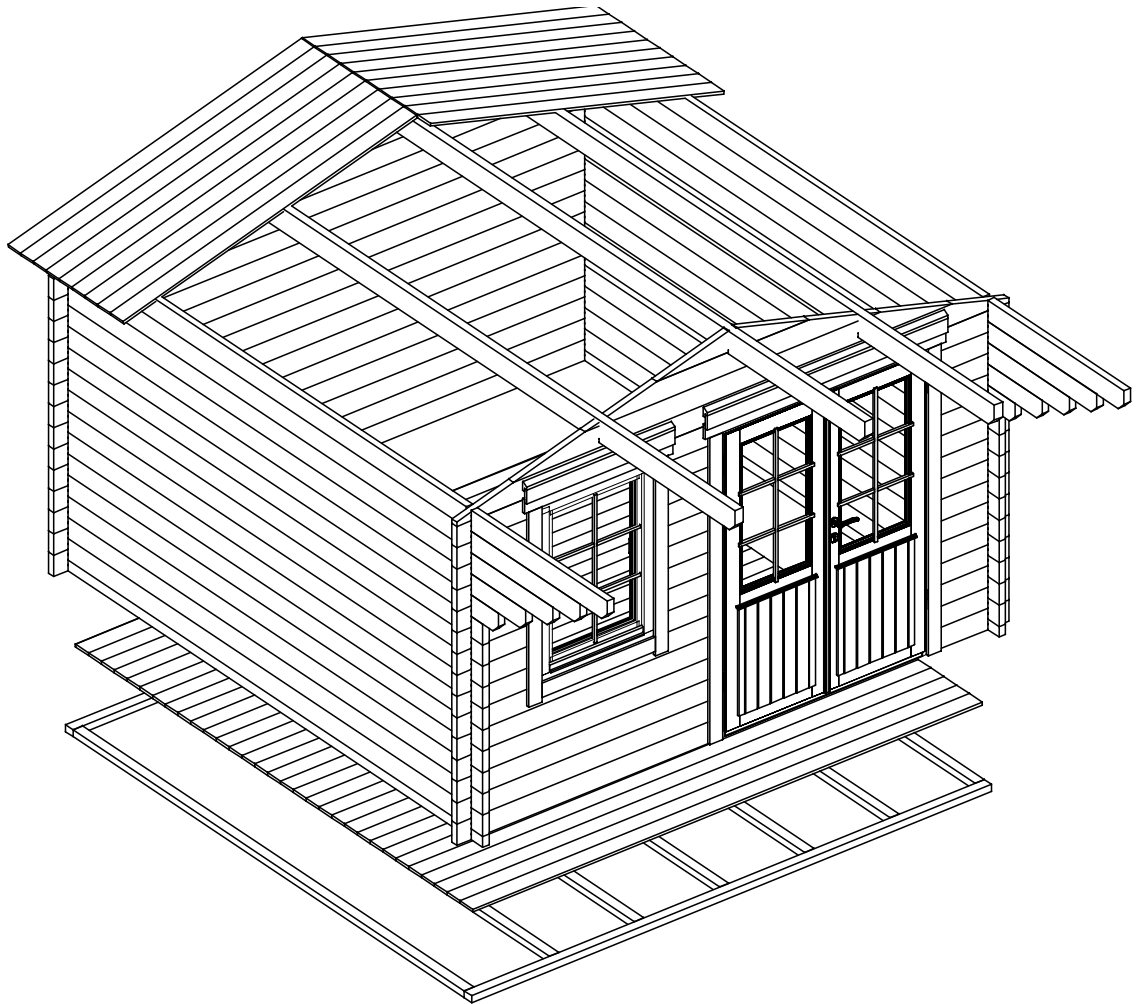

Grundriss Lisa 44-B

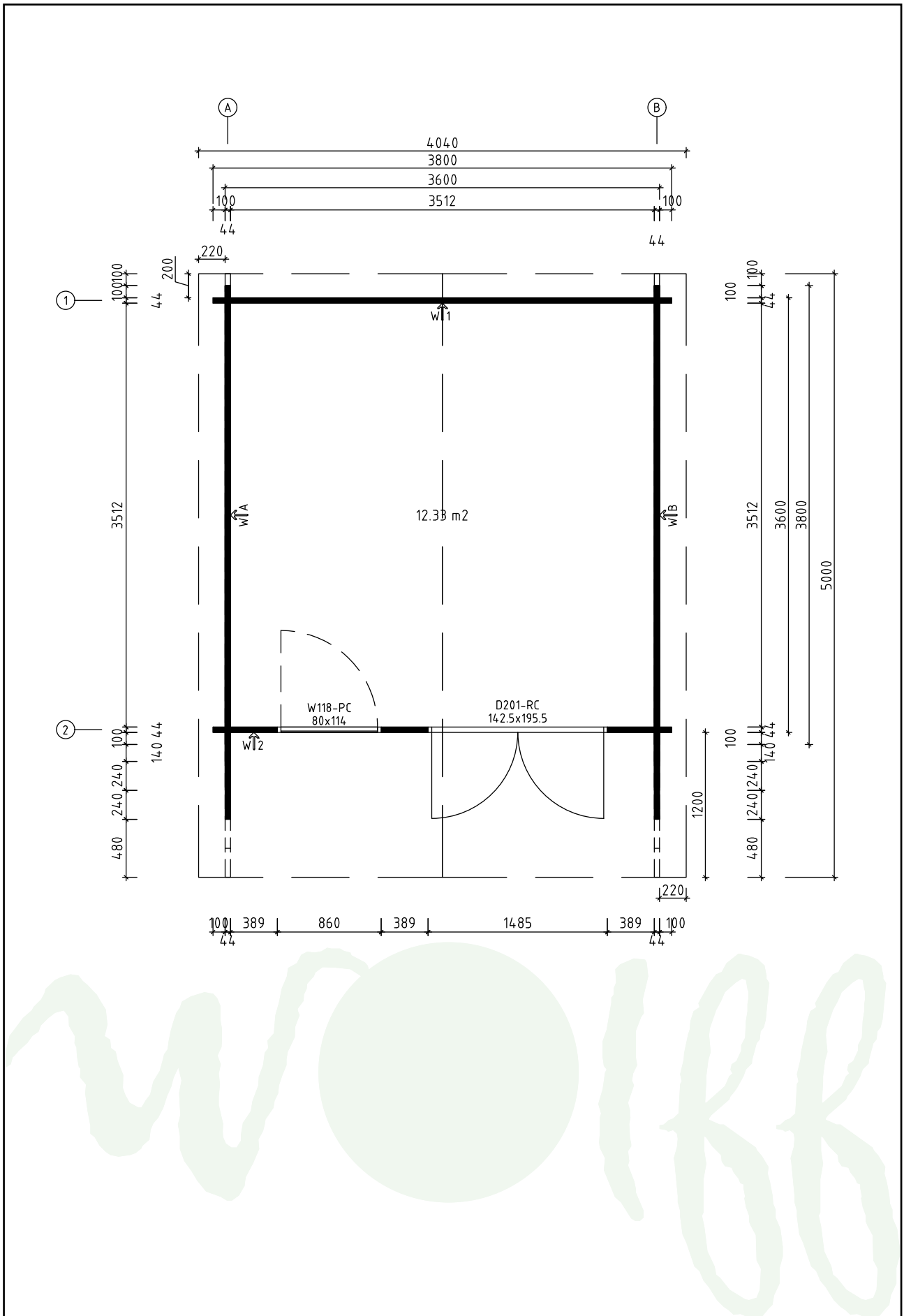





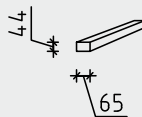
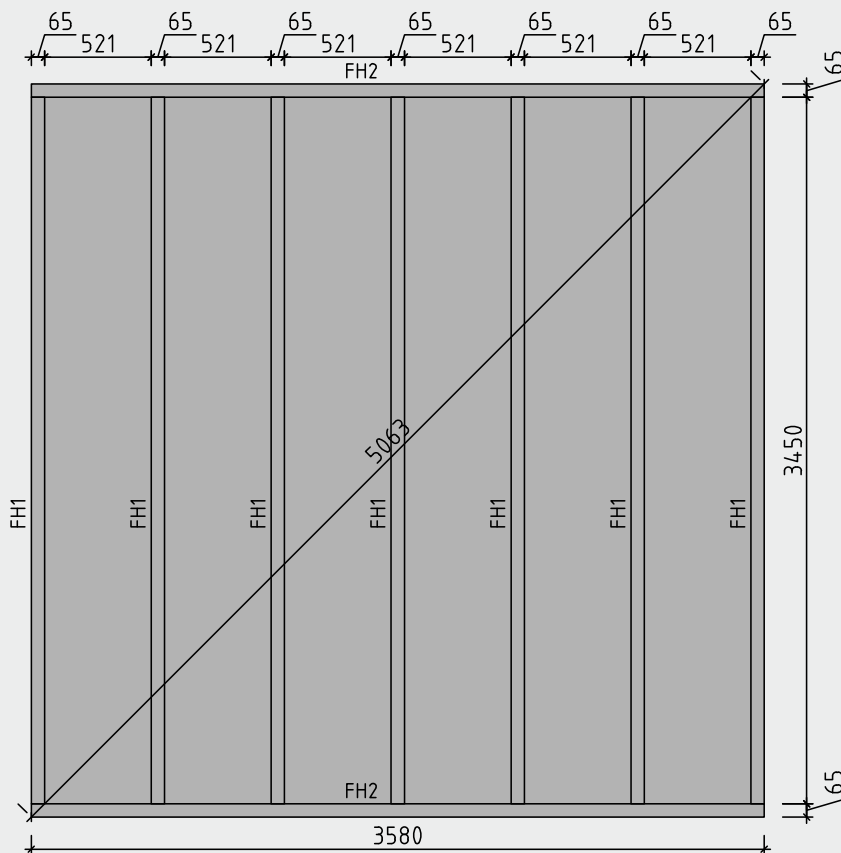





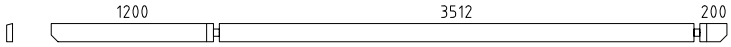

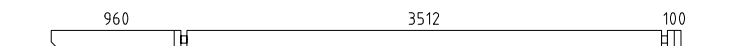
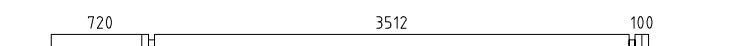
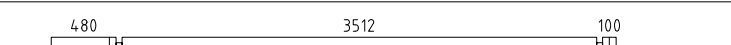



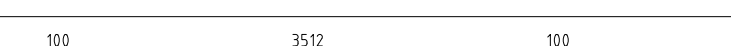
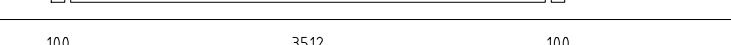
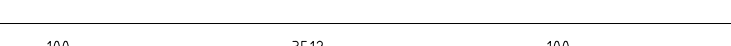
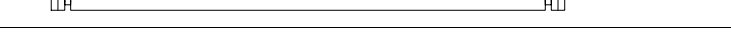
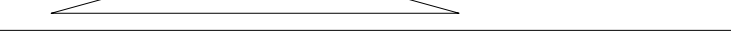

Lagerholzplan und Fundamentplan Lisa 44-B

Wir empfehlen als Fundament für Ihr Gartenhaus eine vollflächig,
festgegründete gepflasterte oder betonierte Fläche.
Wahlweise ist auch ein Punkt- oder Streifenfundament möglich.



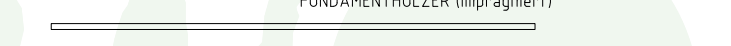













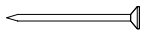

Teileliste 1

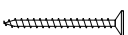
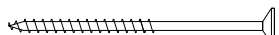
Lisa 44-B

Pos		Stck	Profil (mm)	Länge (mm)
001		1	44x135	5000
002		1	44x135	5000
003		2	44x135	4660
004		2	44x135	4420
005		2	44x135	4180
006		2	44x135	3940
007		1	44x135	3800
008		1	44x135	3800
009		15	44x135	3800
010		2	44x68	3800
011		20	44x135	3800
012		2	44x135	3019
013		2	44x135	2032
014		1	44x135	1782
015		5	44x135	1782
016		24	44x135	533
017		4	44x135	498
018		7	44x135	389
019		2	44x135	389
FH2	FUNDAMENTHÖLZER (imprägniert) 	2	65x44	3580
FH1	FUNDAMENTHÖLZER (imprägniert) 	7	65x44	3450
PF1	PFETTEN 	3	58x145	5000
	DACHBRETTER 	90+1	113x18	2095
	FUSSBODENBRETTER 	32+1	113x18	3505
	FUSSBODENLEISTEN  ✓		18x40	15.0lfm

Teileliste 2

Lisa 44-B

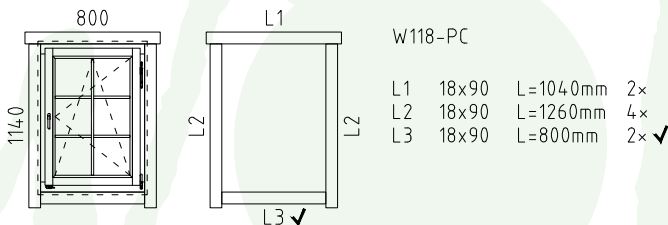
Pos			Stck	Profil (mm)	Länge (mm)
G02-1	GIEBELBRETTER 18x120		4	18x120	2175
G06-1	GIEBELDECKLEISTEN 18x58		4	18x58	2175
T01-1	TRAUFBRETTER 18x95		2	18x95	5000
T06-1	TRAUFENLEISTEN 18x40			18x40	10.0lfm
GS	Giebelsegment		2		
SH	Schlaghölzer		3		
NG04	NÄGEL 2.5x50	Dachbretter Fußbodenbretter		988	
SR32	SCHRAUBEN 3.0x30	Fußbodenleiste Traufenleiste 40x18		48	
SR37	SCHRAUBEN 3.5x45	Giebelbretter 120x18, Giebeldeckleisten 58x18 Giebelsegment, Traufenbretter 95x18 Türleisten: siehe Spezifikation für Fenster und Türen		112	
SR57	SCHRAUBEN 5.0x100	Fundamenthölzer		36	
ML1	Metallstange		1	D10	900
ML2	Metallstange		1	D10	770
KL1	Gewindestange M8		4		2000
KL2	Gewindestange M8		4		123
	Mutter M8		8		
	U-Scheibe M8 Ø25		8		
	Befestigungsmutter M8		4		
	FENSTER	800x1140 W118-PC 44	1		
		 <p>W118-PC</p> <p>L1 18x90 L=1040mm 2x L2 18x90 L=1260mm 4x L3 18x90 L=800mm 2x ✓</p>			

Teileliste 3

Lisa 44-B

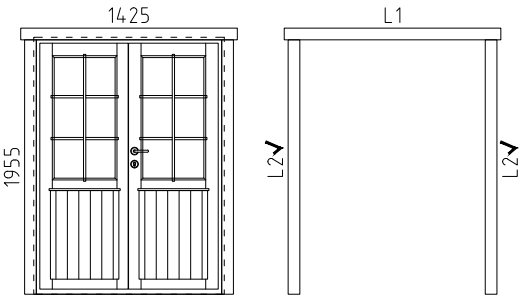
Pos		Stck	Profil (mm)	Länge (mm)
TÜR	1425x1955 D201-RC 44  <p>D201-RC</p> <p>L1 18x90 L=1665mm 2x L2 18x90 L=1955mm 4x ✓</p> <p>DIN rechts</p>	1		
	✓ - bitte selber anpassen (falls nötig)!			

Wandplan 1 und 2

Lisa 44-B

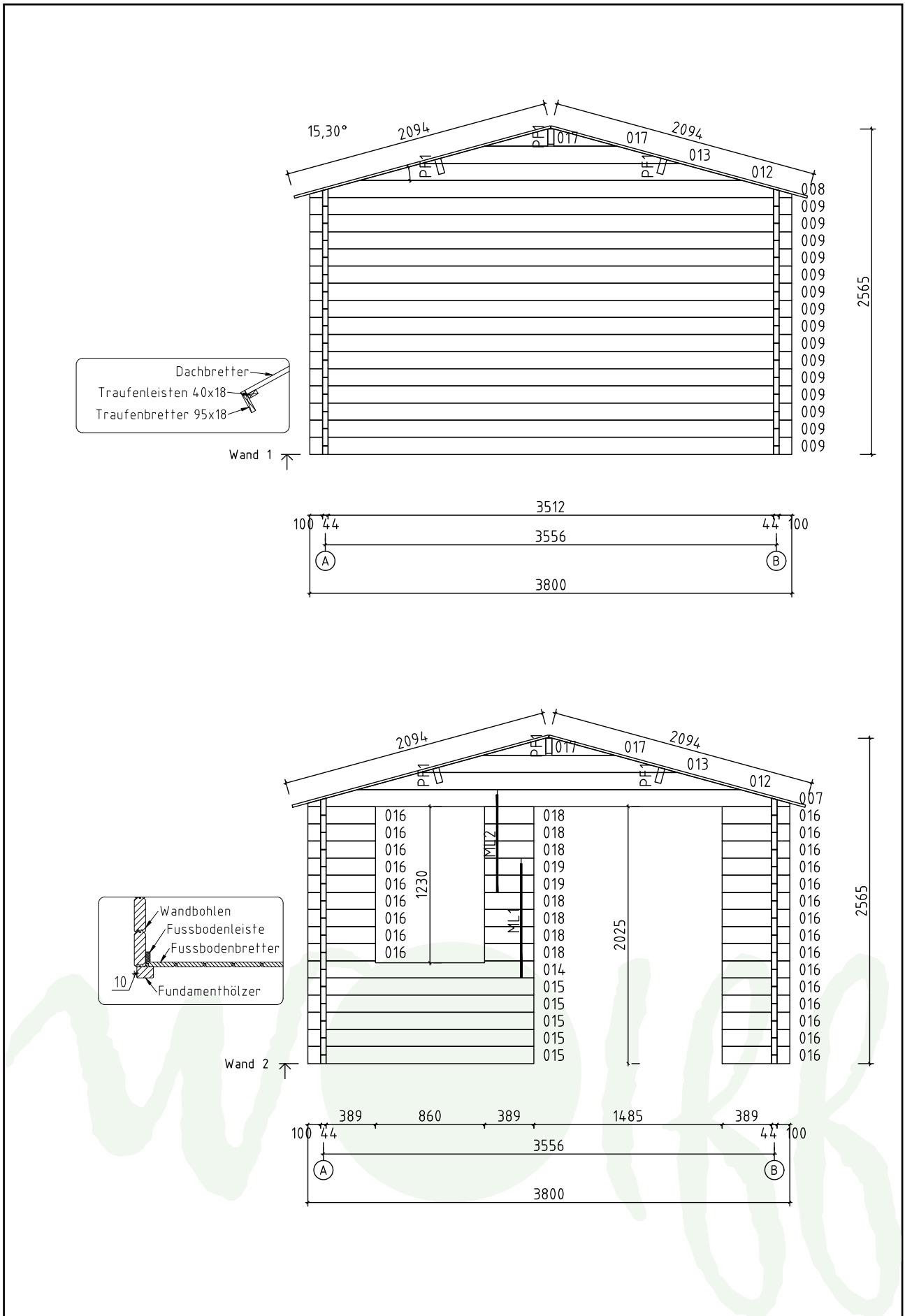

Wandplan A und B Lisa 44-B

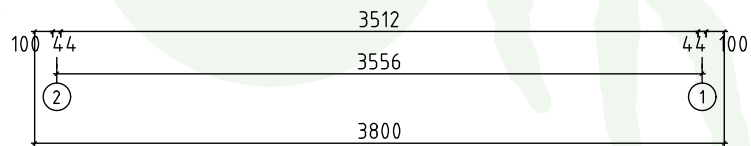
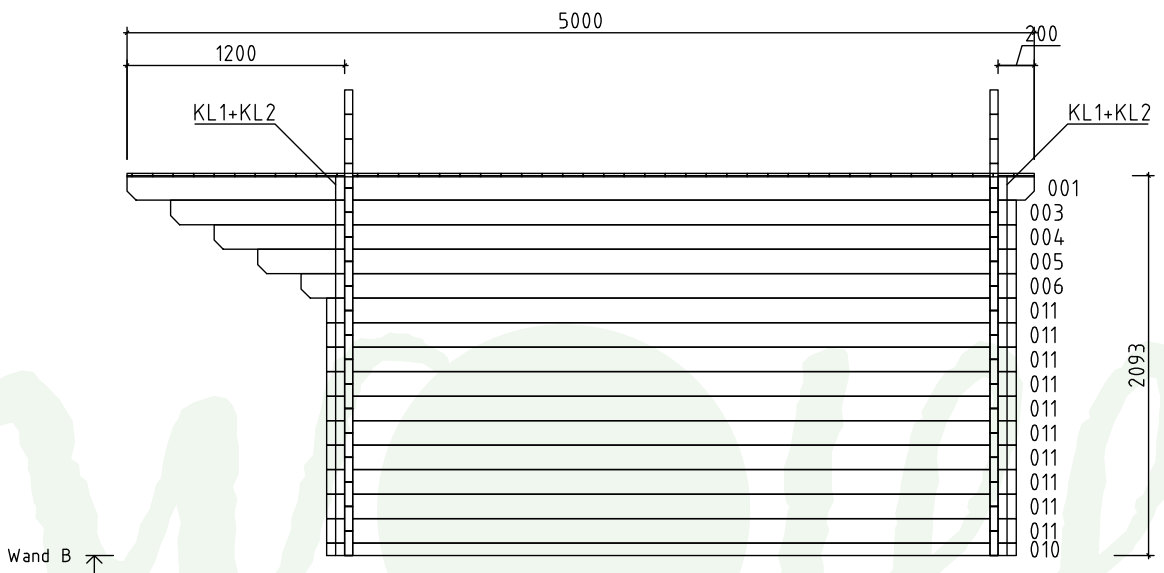
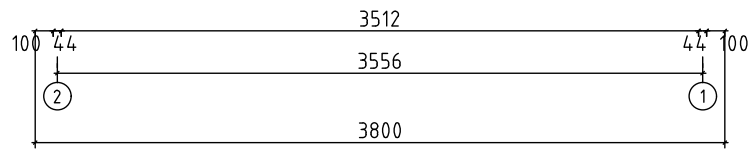
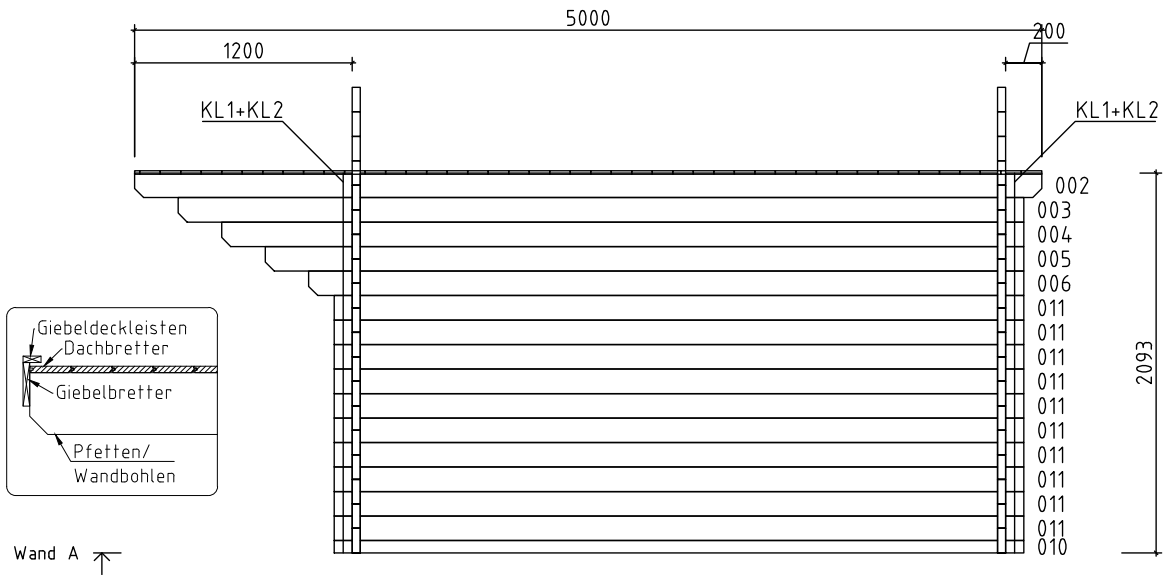

Details

Lisa 44-B

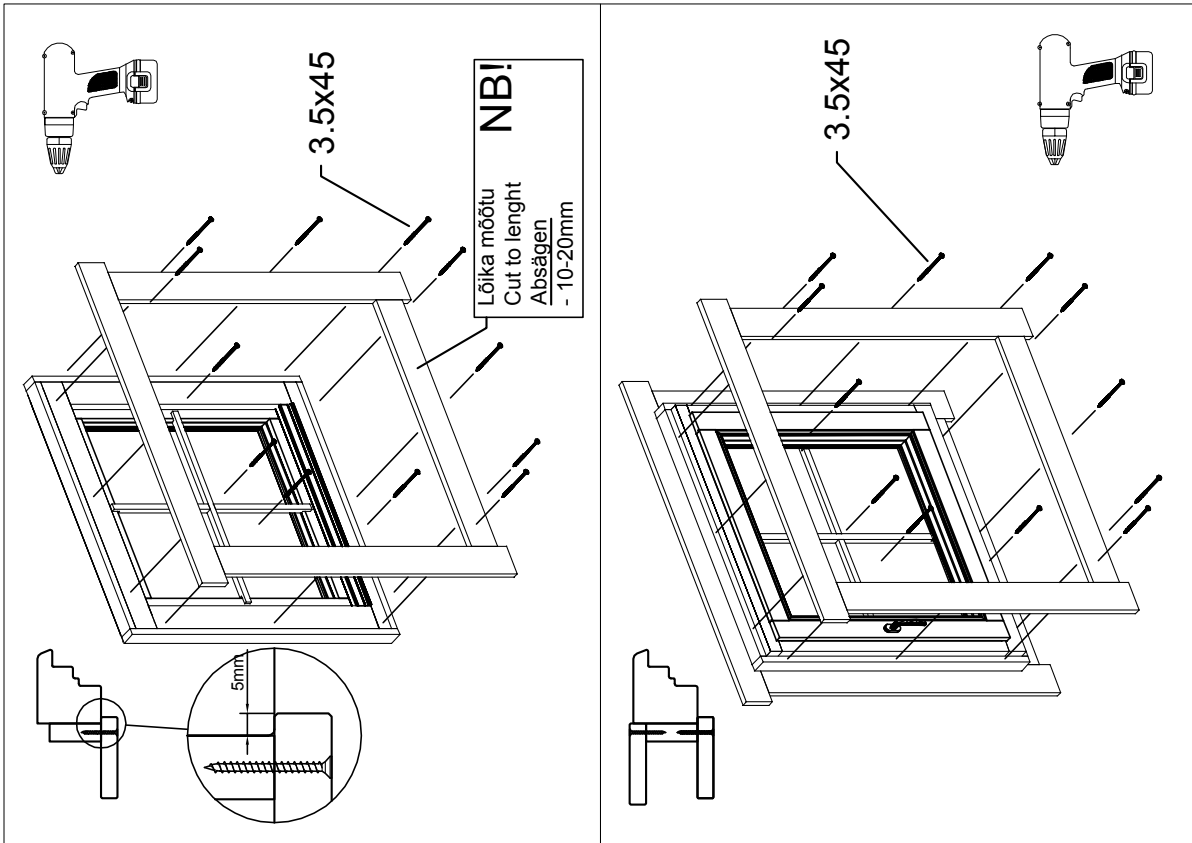

Akna tüüp / Fenster typ / Window type - A68
(GH+ / SH)

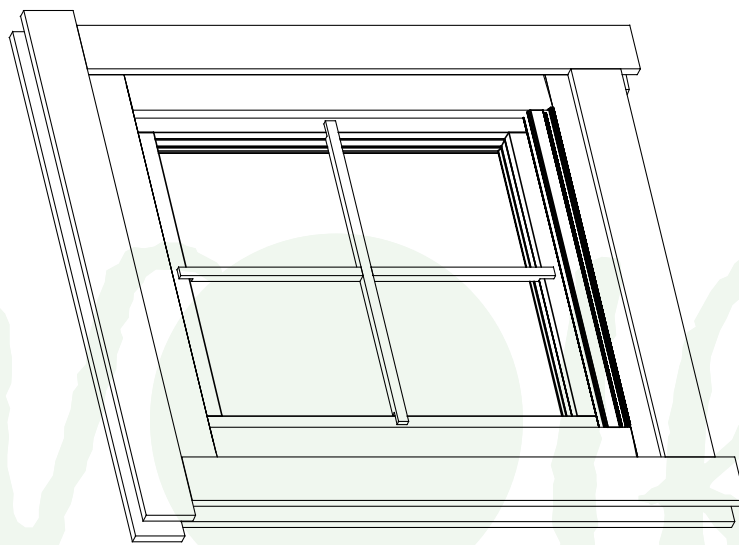

Details

Lisa 44-B

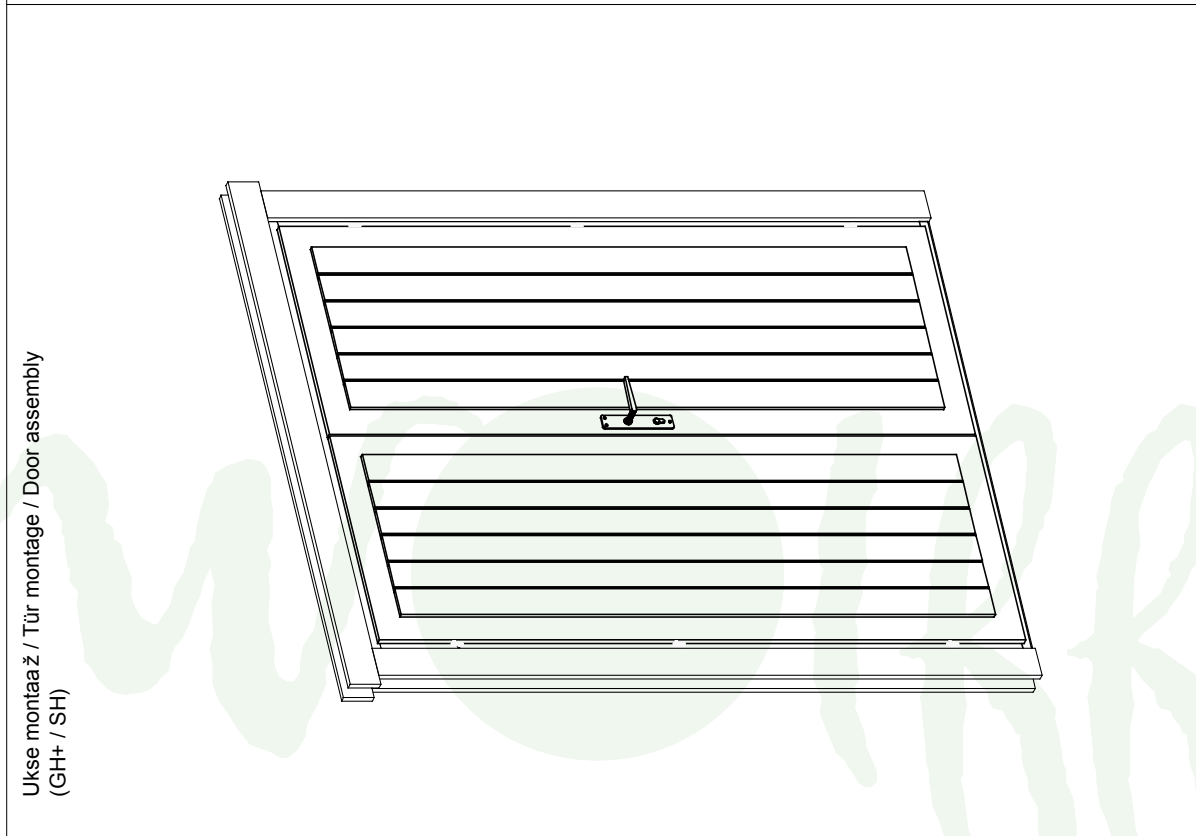
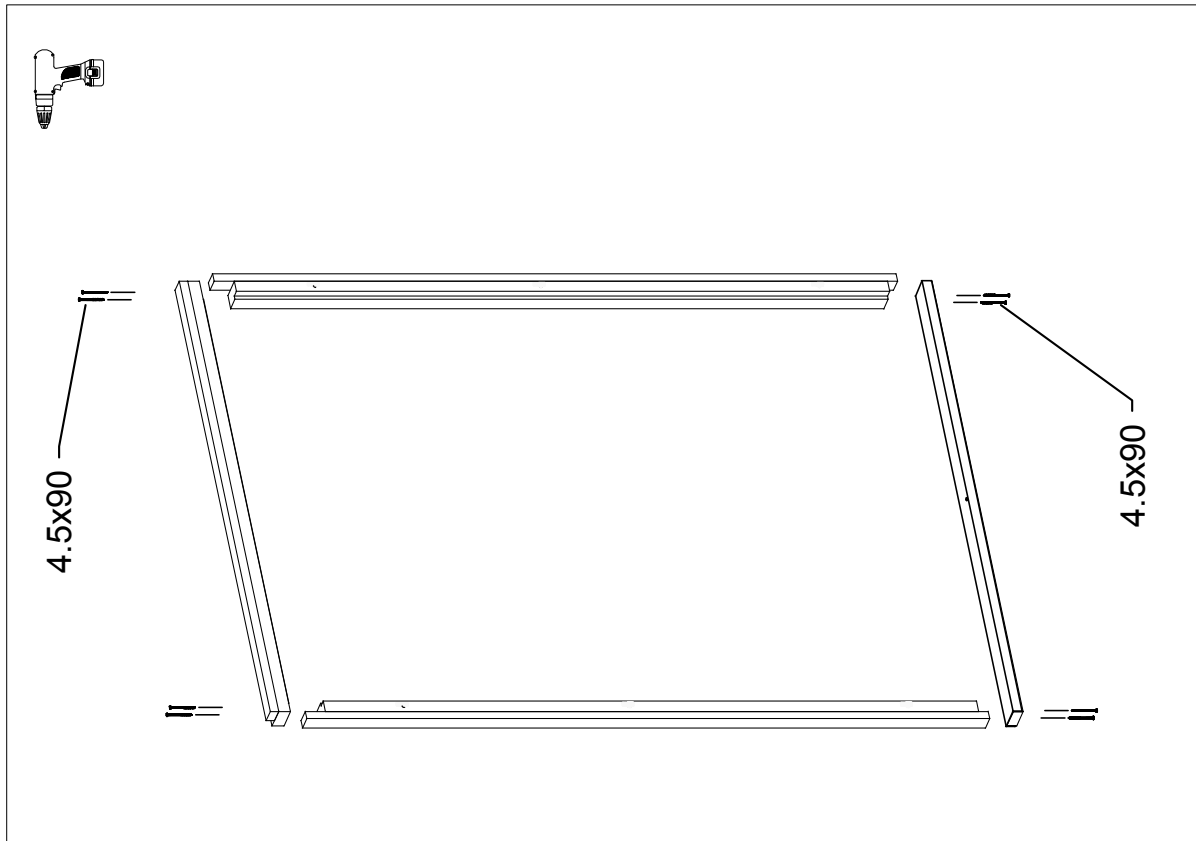

Details Lisa 44-B

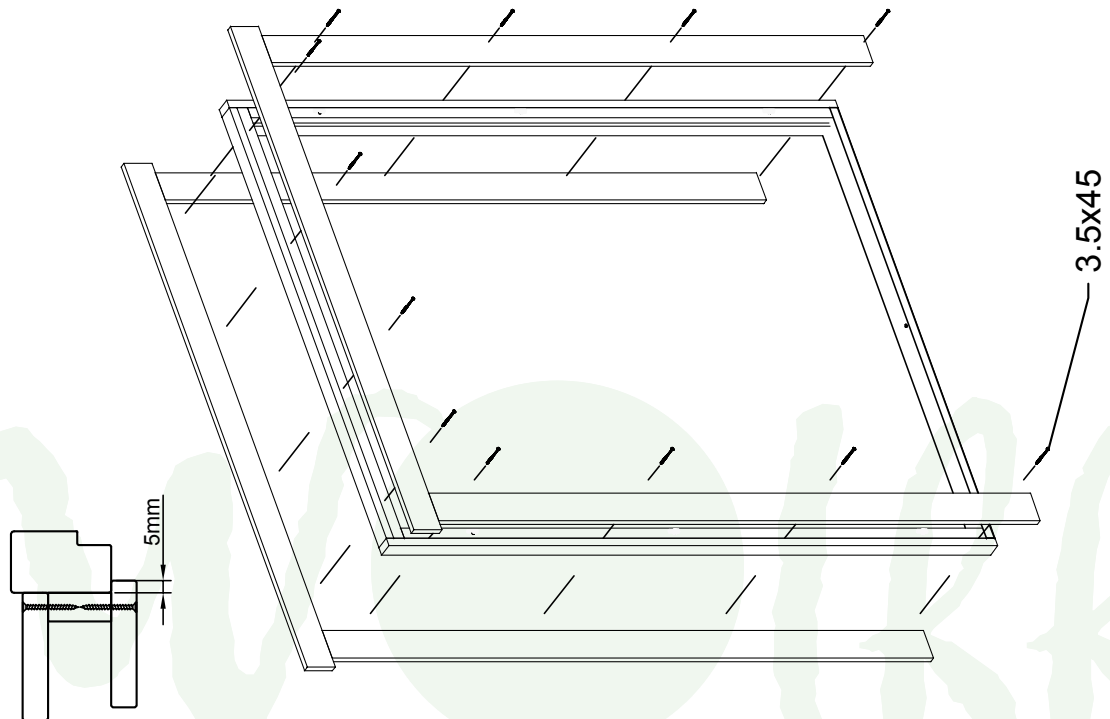
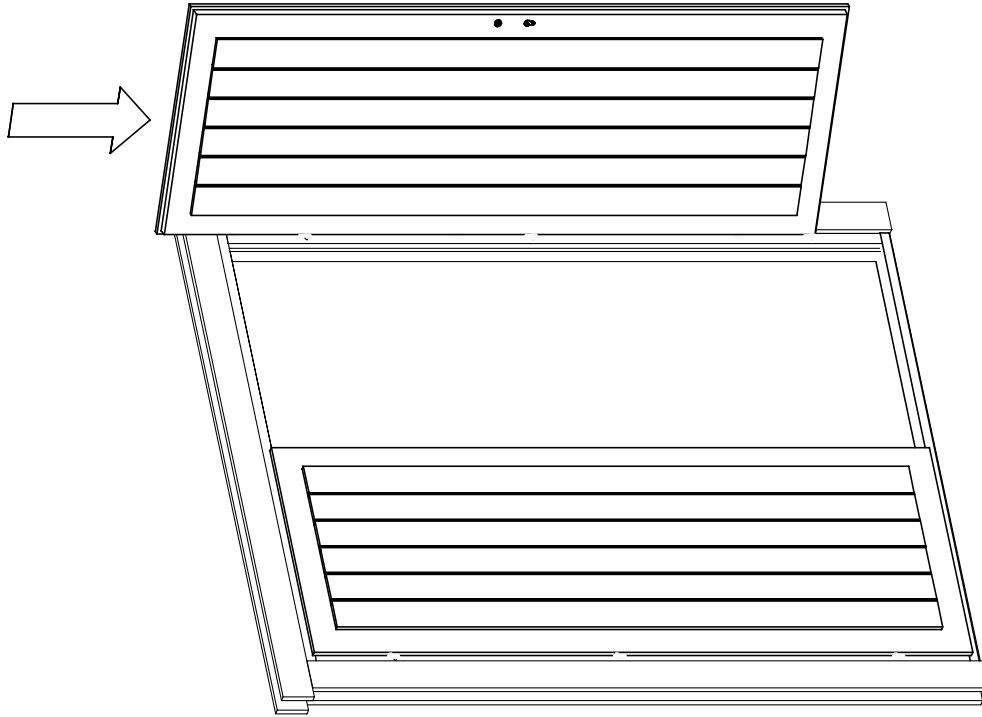

Details

Lisa 44-B

