

8	9	10	11	12	13
1376	1548	1720	1892	2064	2236
-	-	-	-	-	-
1872	2106	2340	2574	2808	3000

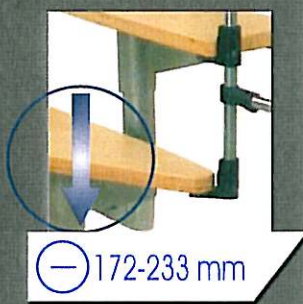

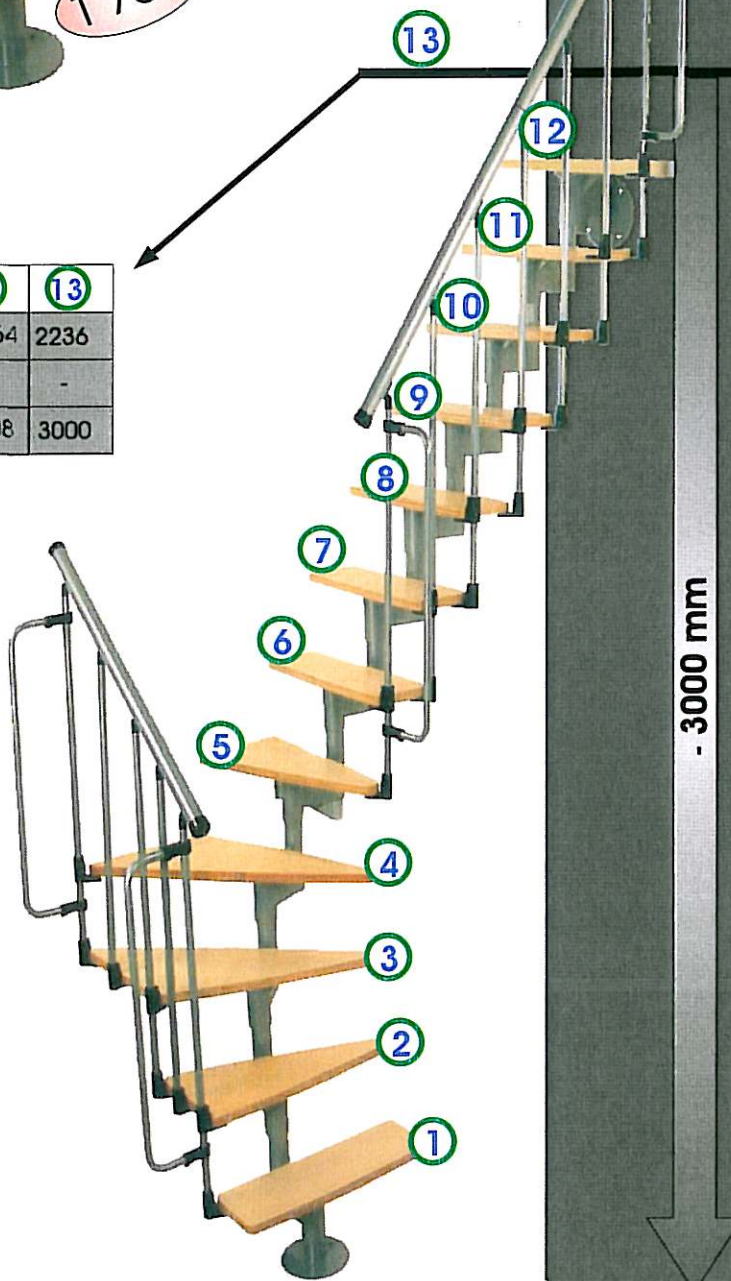
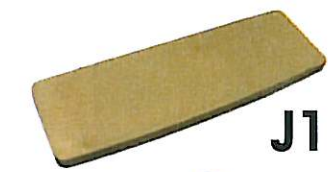

**J1**

12 x - 930034

12 x - 932053

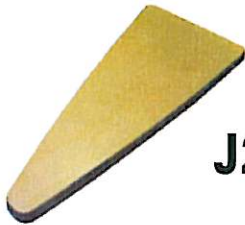

**J2**

2 x - 932035

2 x - 932054

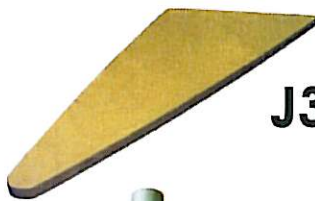

**J3**

2 x - 932036

2 x - 932055



**J4**

11 x - 921012



**J5**

1 x - 921013



**J6**

1 x - 920487



**J7**

1 x - 920485

Ø 22 x 995mm

**J8**

17 x - 932039



**J9**

4 x - 932037



**J10**

1 x - 921006

1 x - 921008



**J11**

1 x - 921007



**J12**

M8 x 1000 mm

3 x - 930706



**J13**

Ø50 x 952 mm

3 x - 932038

3 x - 931261



**J14**

17 x - 930631



**J15**

4 x - 932138



**J16**

11 x - 930851



**J17**

17 x - 932031



**J18**

34 x - 932032



**J19**

17 x - 913217



**J20**

5 x - 932137



**J21**

8 x - 930623

M10 x 70mm DIN 933



2 x - 931060

M8 x 70mm DIN933



15 x - 931735

M8 x 55mm DIN933



2 x - 930656

M5 x 20mm DIN7991



17 x - 930676

M10 x 8mm DIN914



24 x - 931062

M6 x 6mm DIN914



50 x - 930632

Ø5 x 30mm



102 x - 930200

Ø5 x 25mm



72 x - 931063

Ø3,9 x 16mm DIN7504P



34 x - 931221

M8 x 55mm



15 x - 931733

M6 DIN562



50 x - 930633

M5 DIN934



17 x - 930727

M8 DIN934



6 x - 930233

M8 DIN6334



2 x - 930679

M10 DIN1587



2 x - 931879

Ø 30mm M10 DIN9021A



8 x - 930600

Ø16mm M8 DIN125A



19 x - 931078

Ø19mm M10 DIN125A



2 x - 931061

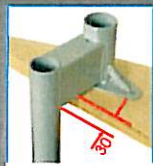
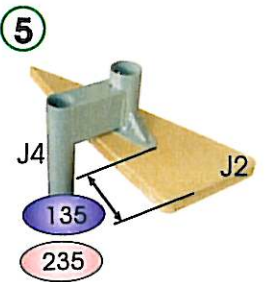
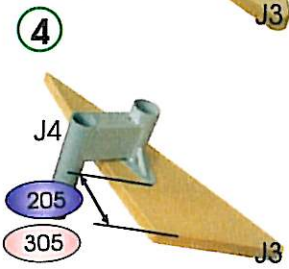
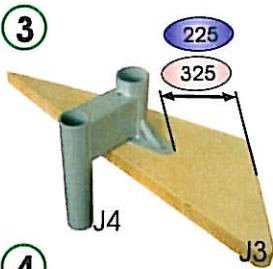
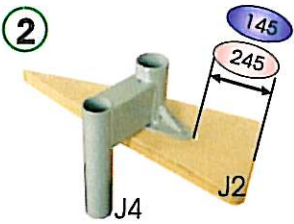
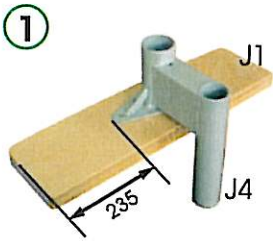

② 30 mm



③ 6 x J29

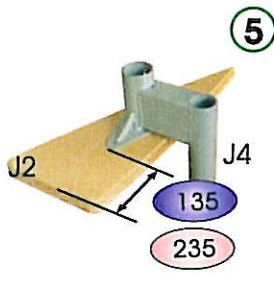
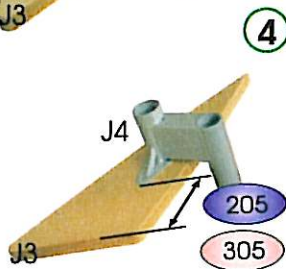
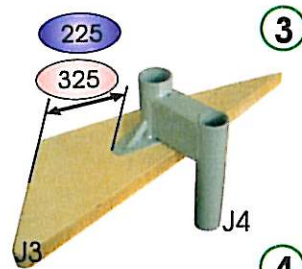
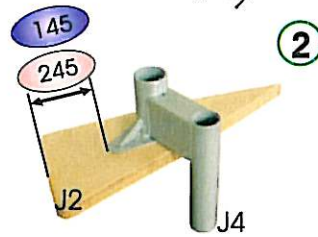
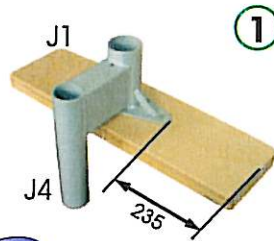

② 30 mm



③ 6 x J29

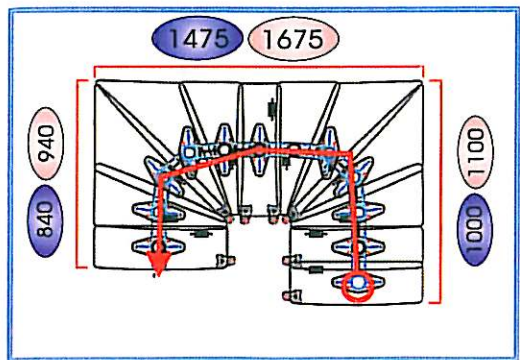
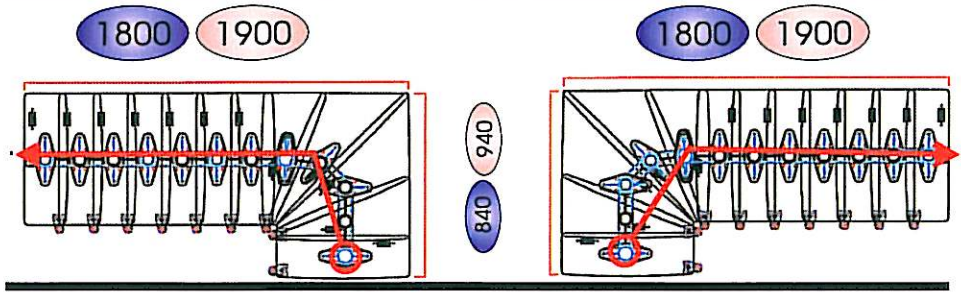
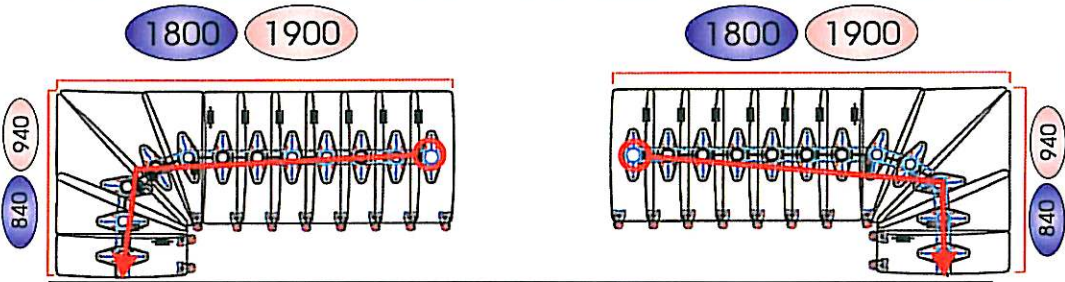
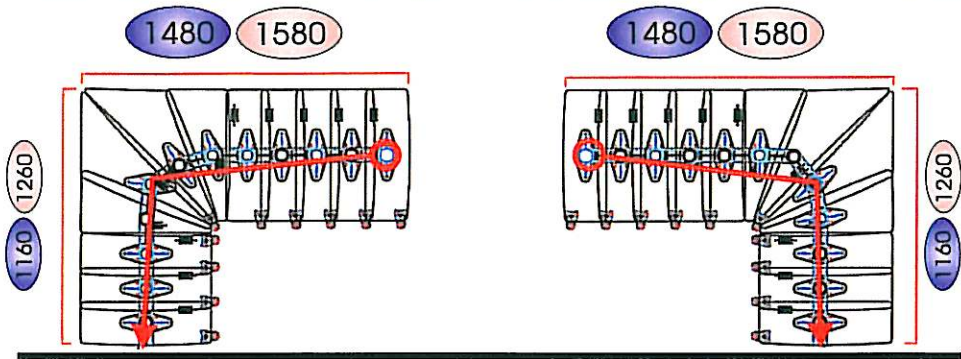
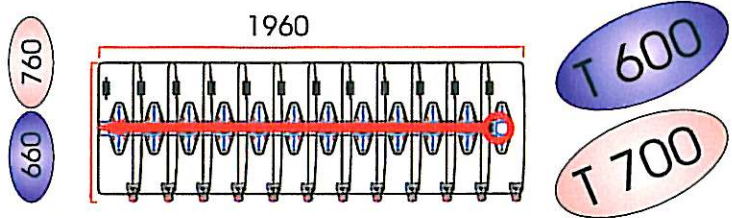

1

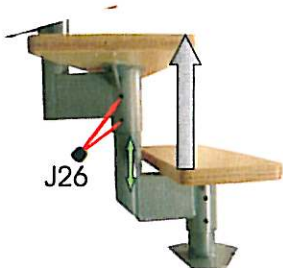

4 172 - 233 mm

5 2 x J26



6 J26

7  $\varnothing 12$  mm

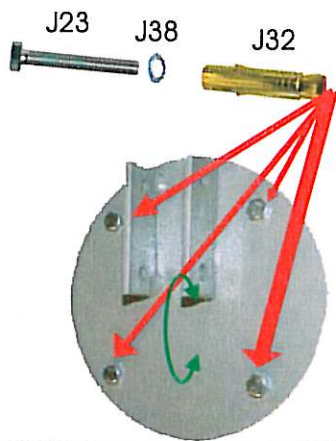

8 13

9 0° / 180°



10 17

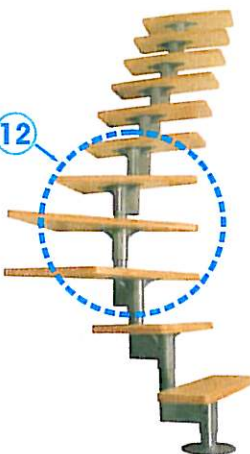

11 -

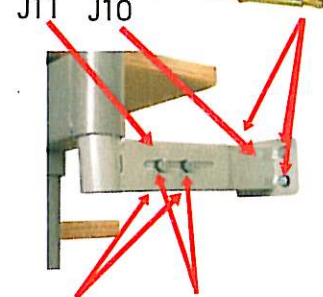

12  $\varnothing 12$  mm



13 13

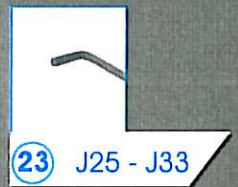
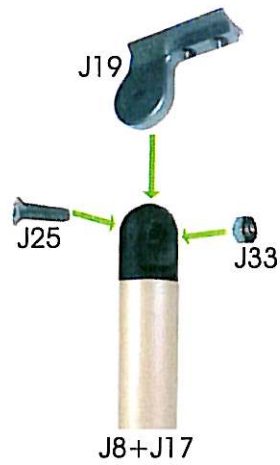
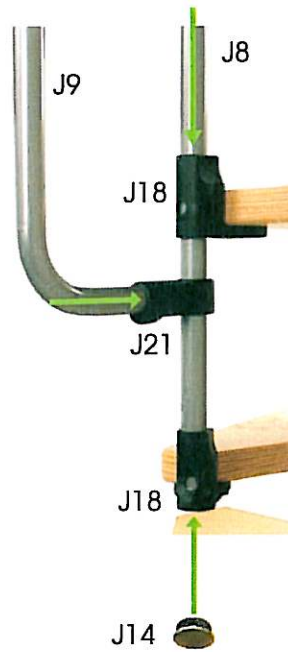
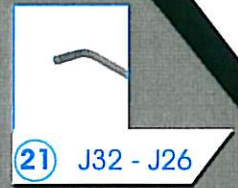
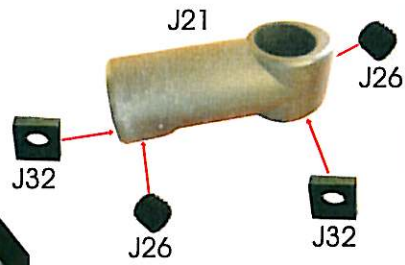
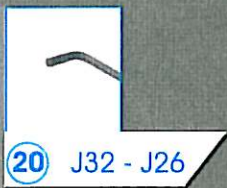
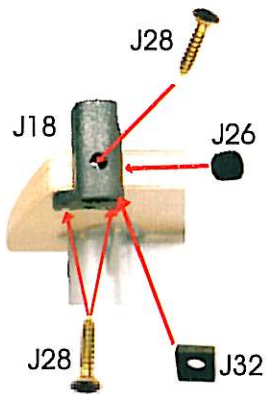
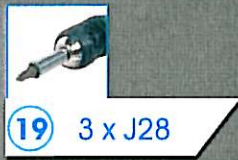
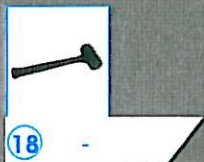
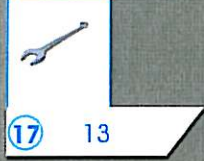
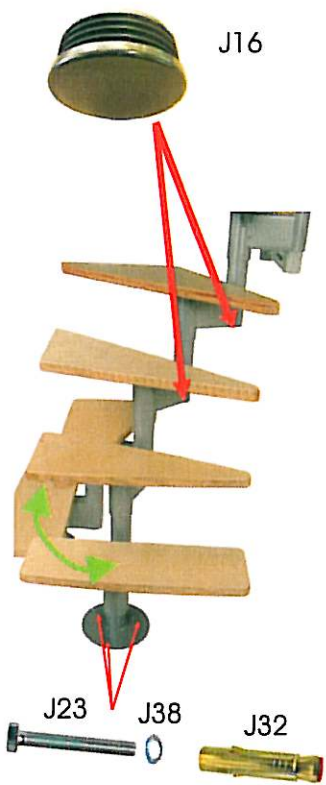



24 -

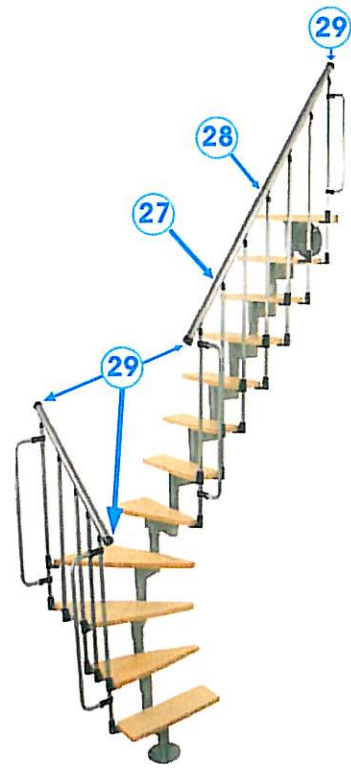

26 -



25 -

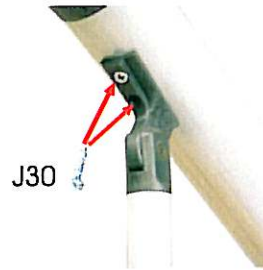

27 2 x J30

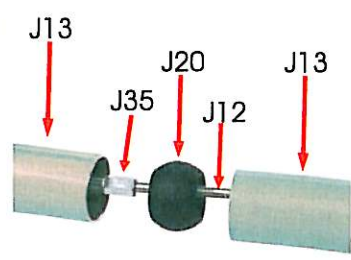

28 13

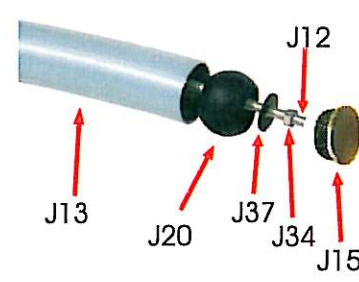

29 13