

Technische Daten

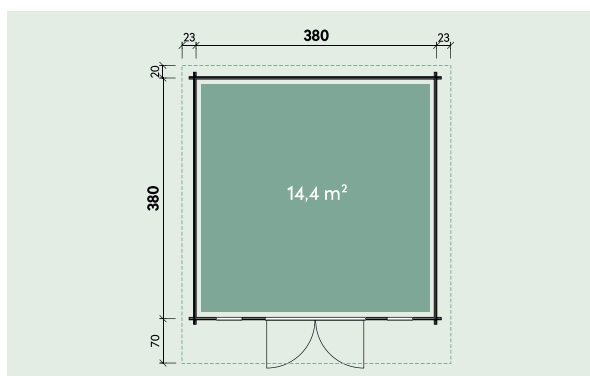

Artikelnummer:







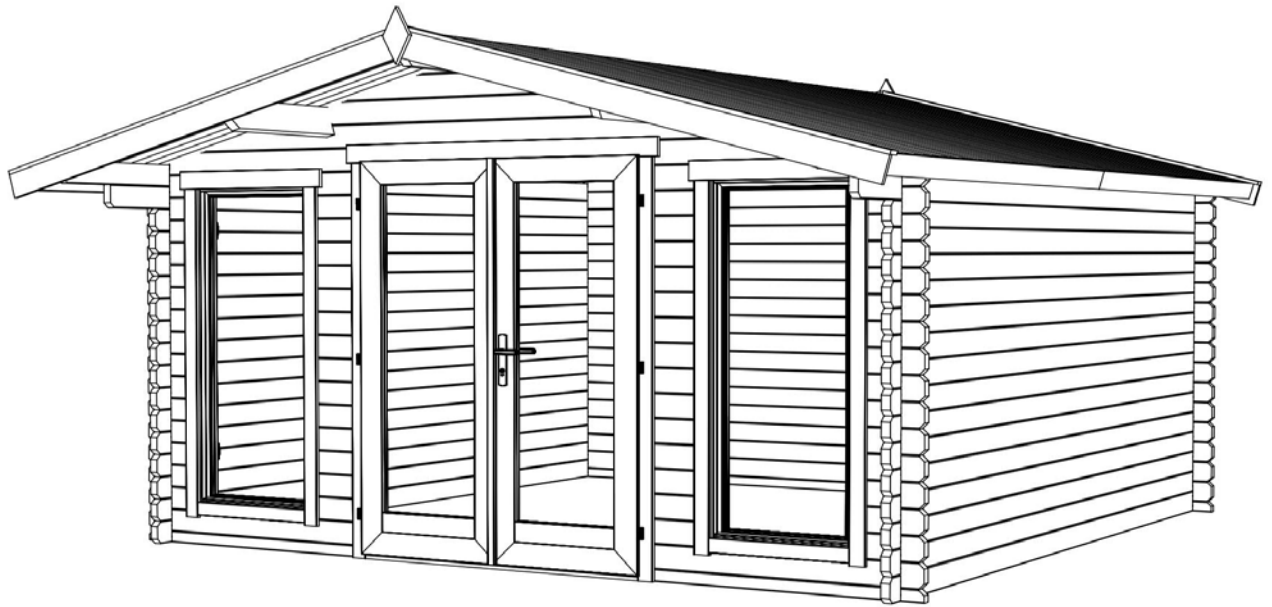

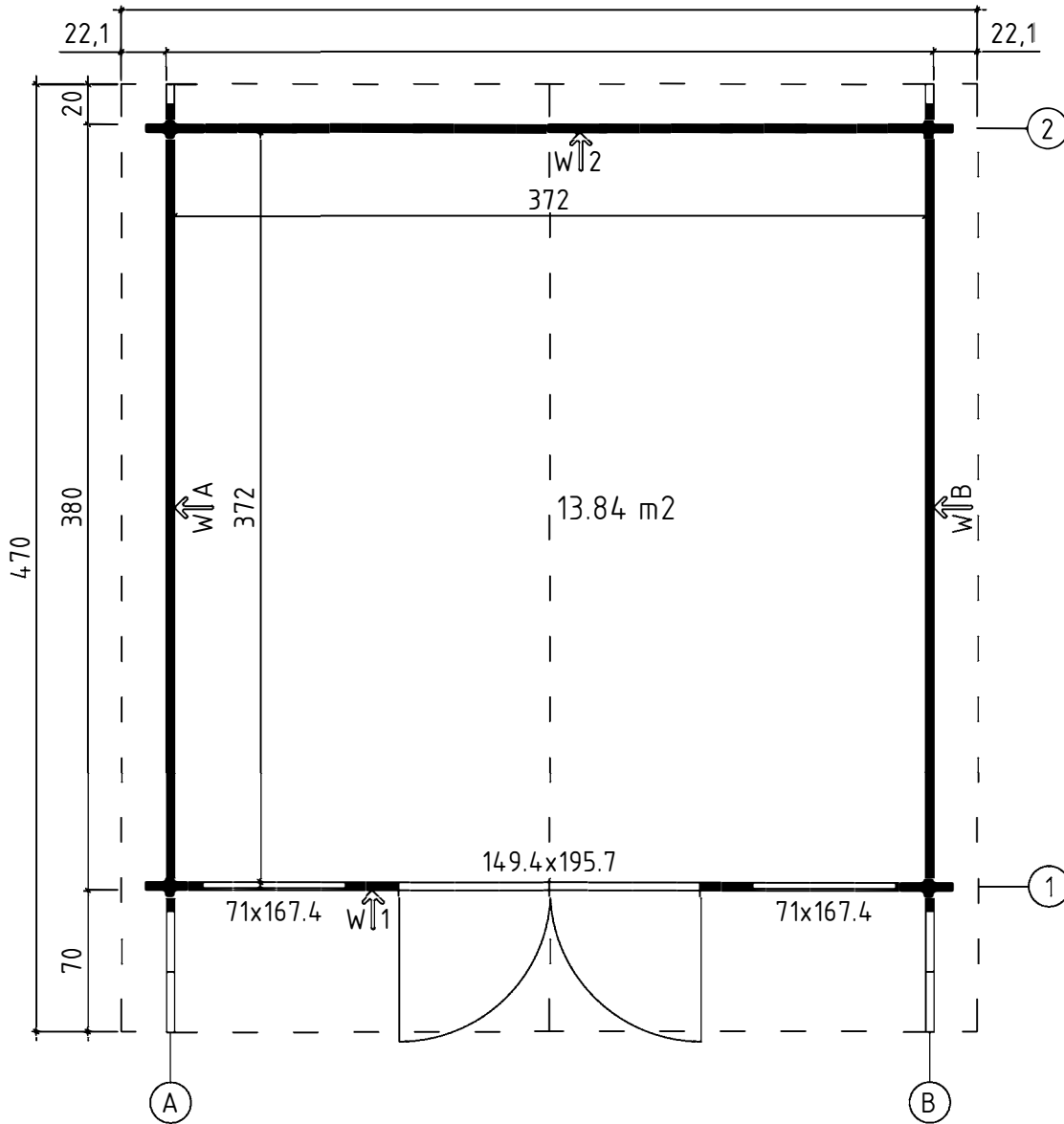

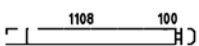
840 540 | 850 051 | 850 052

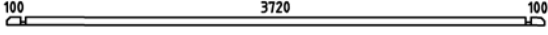
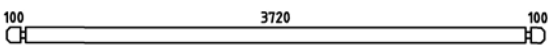
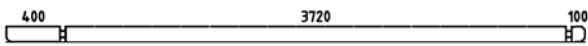
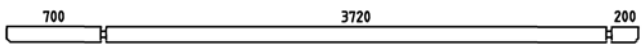
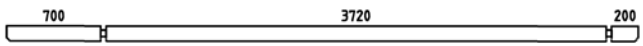
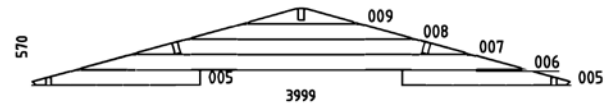
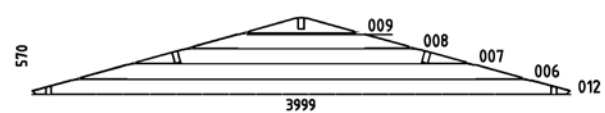
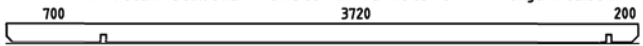

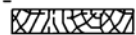



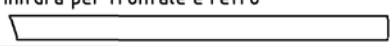



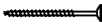

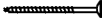
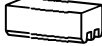
Kontrolliert durch:



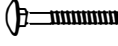
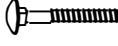



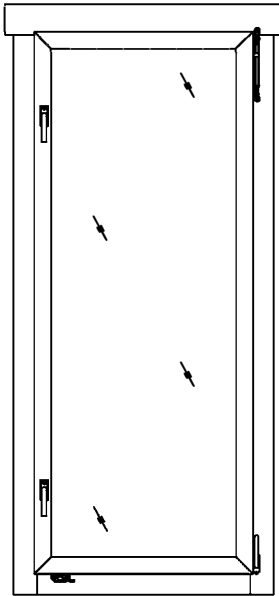
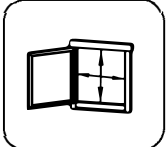

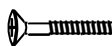

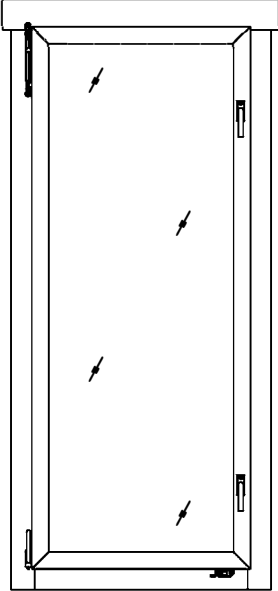
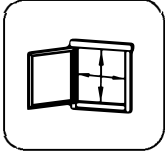

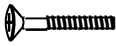

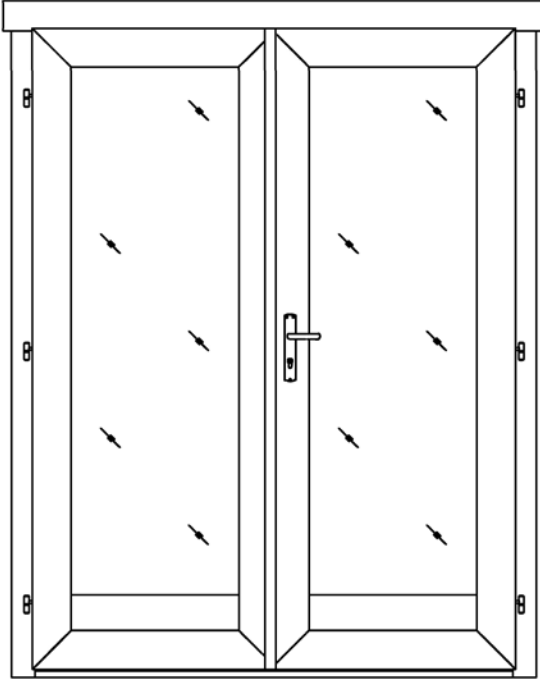
Pos			P (mm)	L (mm)	
001			2	40x57	1248
002			2	40x114	1248
003			30	40x114	278
004			30	40x114	252
010			1	40x57	4000
011			46	40x114	4000
013			2	40x114	4300
014			1	40x114	4700
015			1	40x114	4700
W1-1			1		
W2-1			1		
A-PR1	Roof beam - Dachbalken - Panne de toit - Perlina del tetto - Gordingen / dakbalk - Pärilin 		3	44x140	4700
	Roof boards - Dachbretter - Voliges - Perlina per tetto - Dakhout - Katuselaud 		106	90x18	2200
	Roofing felt fillet - Dachpappenteiste - Baguette de fixation du feutre bitumeux - Asse per fissaggio guaina bituminosa - Afdeklijst asfaltpapier - Kafusepapiiist 		4	18x58	2250
TB-1	Fascia board - Traufbrett - Bandeau de toit - Finitura lati tetto - Gevellijst - Räästalaud 		4	18x90	2350
DRV-1	Roof edge reinforcement - Dachrandverstärkung - Corniere de renfort de bord de toit - Rinforzo x tetto - Dakrand versterking - Räästatugevdus 		4	28x34	2350
KFS-2	Storm protection - Sturmleiste - Latte anti-tempete - Protezione anti vento - Stormverankering / beveiliging - Tormikinnitusliist 		2	22x45	2050
KFS-1	Storm protection - Sturmleiste - Latte anti-tempete - Protezione anti vento - Stormverankering / beveiliging - Tormikinnitusliist 		2	44x44	1900
	Gable moulding - Giebelleiste - Planche de rive - Finitura per frontale e retro del tetto - Gevellijst - Viilulaud 		4	18x120	2250
HS8	Screw for gable segment - Schrauben für deckblatt - Vis pour fixation losange de finition - Viti x frontali tetto - Schroef voor gevelpunt segment - Kruvi rombile 		4	3.5x35	
HS9	Screw for gable moulding - Schrauben für giebelleiste - Vis pour fixation planche de rive - Vite per fissare finiture davanti e dietro del tetto - Schroef voor gevellijst - Kruvi viilulauale 		24	3.5x50	

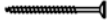
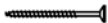
Pos		Q	P (mm)	L (mm)
HS12	Screw for fascia boards - Schrauben für traufbretter - Vis pour fixation bandeau de toit - Viti x striscia del tetto - Schroef voor gevellijst - Kruvi räästalauale 	24	4x40	
HS12	Screw for roof edge reinforcement - Schrauben für dachrandverstärkung - Vis pour fixation corniere renfort de bord de toit - Viti x rinforzo bordo tetto - Schroef voor dakrand versterking - Kruvi räästafugevdusele 	24	4x40	
HS18	Screw for roof beams - Schrauben für dachbalken - Vis pour fixation pannes de toit - Viti per perline del tetto - Schroef voor gordingen / dakbalken - Kruvi pärlinitele 	6	5x120	
HS18	Screw for gable - Schrauben für giebel - Vis pour fixation des pignons - Viti per timpano - Schroef voor gevelpunt - Kruvi viilude kinnitamiseks 	4	5x120	
SH40	Hammer block - Schlagholz - Calle de frappe - Blocco di legno da usare come cuscinetto quando si usa il martello - Slagklos - Löögiklots 	1		
SFS	Nut for storm protection - Schraubenmutter für sturmleiste - Ecrou pour latte anti-tempete - Dado x asta protezione vento - Moer voor stromverankering - Mutter tormikinnitusliistule 	16	D6	
NF4	Zn nail for roof - Zn nägel für dachbretter - Pointe pour fixation voliges de toit - Chiodi x perline tetto - Spijker(nagel) voor dakhout - Nael katuselauale 	332	2x50	
NF5	Zn nail for roofing felt fillet - Zn nägel für dachpappenteleiste - Pointe pour baguette de fixation feutre bitumeux - Chiodi x carta bituminosa x tetto - Spijker(nagel) voor asfaltpapier afdekljst - Papiliistunael 	24	2x40	
BFS	Bolt for storm protection - Bolzen für sturmleiste - Boulon pour latte anti-tempete - Bullone x asta protezione vento - Bout voor stormankerlat - Puidupolt tormikinnitusliistule 	12	6x100	
BFS-2	Bolt for storm protection - Bolzen für sturmleiste - Boulon pour latte anti-tempete - Bullone x asta protezione vento - Bout voor stormankerlat - Puidupolt tormikinnitusliistule 	4	6x70	
GS	Gable segment - Deckblatt - Losange de finition - Decorazione in legno x frontale tetto - Gevelpunt segment - Romb 	2		
DFS	Washer for storm protection - Dichtscheibe für sturmleiste - Rondelle pour latte anti-tempete - Rondella x asta protezione vento - Afdichtring voor storm strip - Seib tormikinnitusliistule 	16	D6	
	Window - Fenster - Fenetre - Finestra - Raam - Aken 710x1674 AK.1.100.SSP.p SGC	1		
	Window - Fenster - Fenetre - Finestra - Raam - Aken 710x1674 AK.1.100.SSV.p SGC	1		
	Door - Tür - Porte - Porte - Deur - Uks 1494x1957 TUK.1.100.SVP.MMb SGC	1		

Pos			P (mm)	L (mm)
	<p data-bbox="343 331 1212 365">Glass size - Glasgröße - Taille de la vitre - Misura del vetro - Glas afmeting - Klaasi mõõt: 566x1530 mm</p> <div style="display: flex; justify-content: space-around; align-items: center;">  <div style="text-align: center;">  <p data-bbox="1300 504 1420 526">610x1574 mm</p> </div> </div>			
FS1	<p data-bbox="343 1971 1005 2027">Window handle fittings - Fenstergriff - Poignee de fenetre - Maniglia c/ferramenta - Raamhendel -/grendel -/klink - Aknalink</p>		2	
FSP	<p data-bbox="343 2038 1077 2105">Bolt for window handle fittings - Bolzen für fenstergriff beschlag - Vis pour fixation poignee de fenetre - Bullone x apertura manuale finestra - Schroef voor raamhendel - Akna käepideme polt</p>		4	

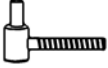
Pos			P (mm)	L (mm)
	<p data-bbox="220 331 1110 360">Glass size - Glasgröße - Taille de la vitre - Misura del vetro - Glas afmeting - Klaasi mõõt: 566x1530 mm</p> <div data-bbox="595 421 874 1010" style="text-align: center;">  </div> <div data-bbox="1150 338 1315 488" style="text-align: center;">  </div> <p data-bbox="1177 506 1286 530">610x1574 mm</p>			
FS1	<p data-bbox="220 1973 879 2024">Window handle fittings - Fenstergriff - Poignee de fenetre - Maniglia c/ferramenta - Raamhendel -/grendel -/klink - Aknalink</p> <div data-bbox="1002 1966 1086 2033" style="text-align: center;">  </div>		2	
FSP	<p data-bbox="220 2040 951 2110">Bolt for window handle fittings - Bolzen für fenstergriff beschlag - Vis pour fixation poignee de fenetre - Bullone x apertura manuale finestra - Schroef voor raamhendel - Akna käepideme polt</p> <div data-bbox="970 2056 1086 2101" style="text-align: center;">  </div>		4	

		Q	P (mm)	L (mm)	
	<p>Glass size - Glasgröße - Taille de la vitre - Misura del vetro - Glas afmeting - Klaasi mõõt: 514x1593 mm</p>   <p>1394x1875 mm</p>				
HS4	Screw for door fillet - Schraube zur befestigung türleiste - Vis pour fixation baguette d'arret de porte - Viti per massellino della porta - Schroef voor deurlijst - Kruvi ukse kokkuvaltisliistule		5	3x30	
HS16	Screw for door jamb - Schraube für türrahmen - Vis de fixation partie haute avec montants du cadre de porte - Viti x fissaggio montanti porte - Schroef voor deurkozijn - Kruvi ukse lengile		4	5x90	
HS25	Screw for doorstep - Schrauben für swelle - Vis pour fixation barre de seuil - Vite per soglia della porta - Schroef voor deurdorpel - Kruvi lävepakule		3	4.5x65	
TL4	Door handle fittings - Türgriff - Poignee de porte - Maniglie - Deurhendel / klink - Ukse käepide		1		
TL5	Set of door lock covers - Schlossblenden - Set de garnitures de porte - Copertura serrature - Slot sluitplaat set - Ukse lukuplaat		1		
	Cylinder lock - Zylinderschloss - Barillet de porte - Serratura - Cylinder slot - Ukse lukusüdamik		1	30x35	
	Male bolt hinge for door - Türband - Partie male de paumelle de porte - Cerniera anube x porta - Scharnier bout - Ukse polthing isane		6		
	Striker for barrel bolt - Hülse für grendelriegel - Gache au sol du targette - Boccola per fermo della porta - Huls voor vergrendelingsschuif - Vasturaud ukse servariivile		2		

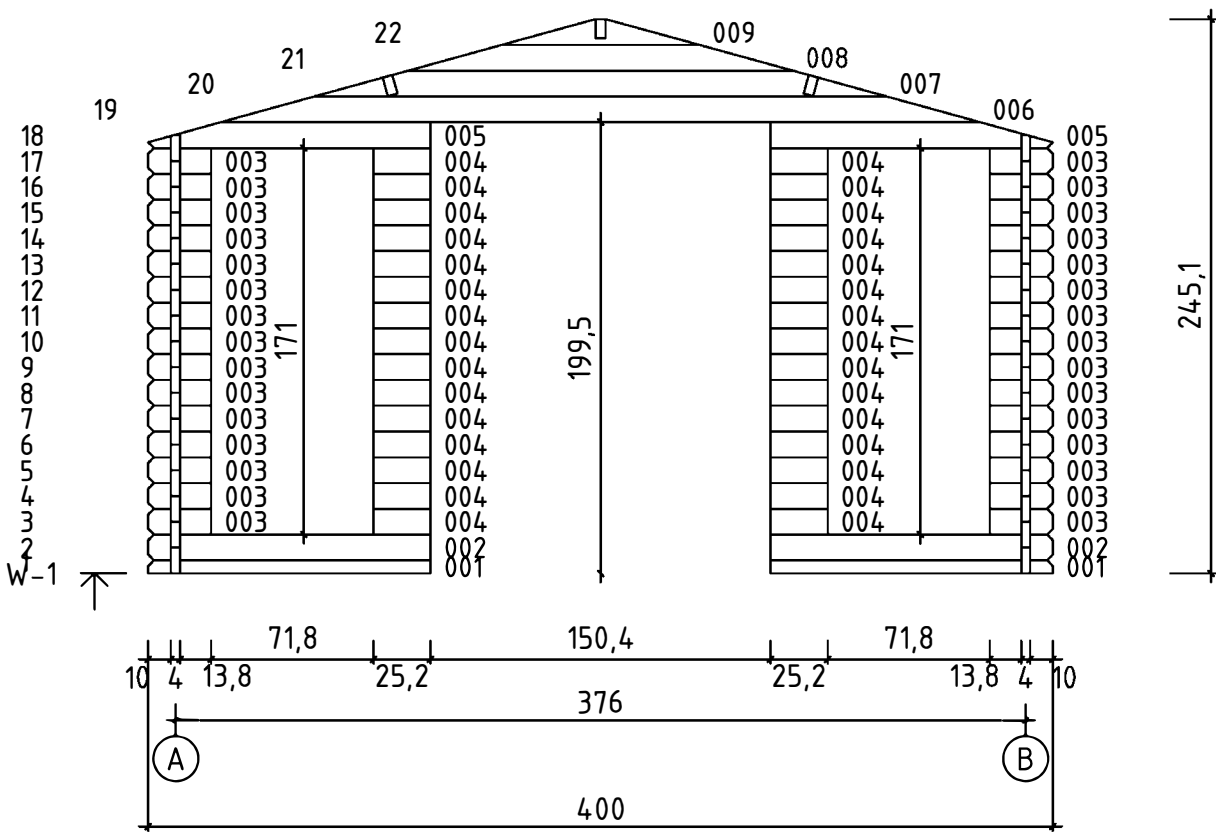

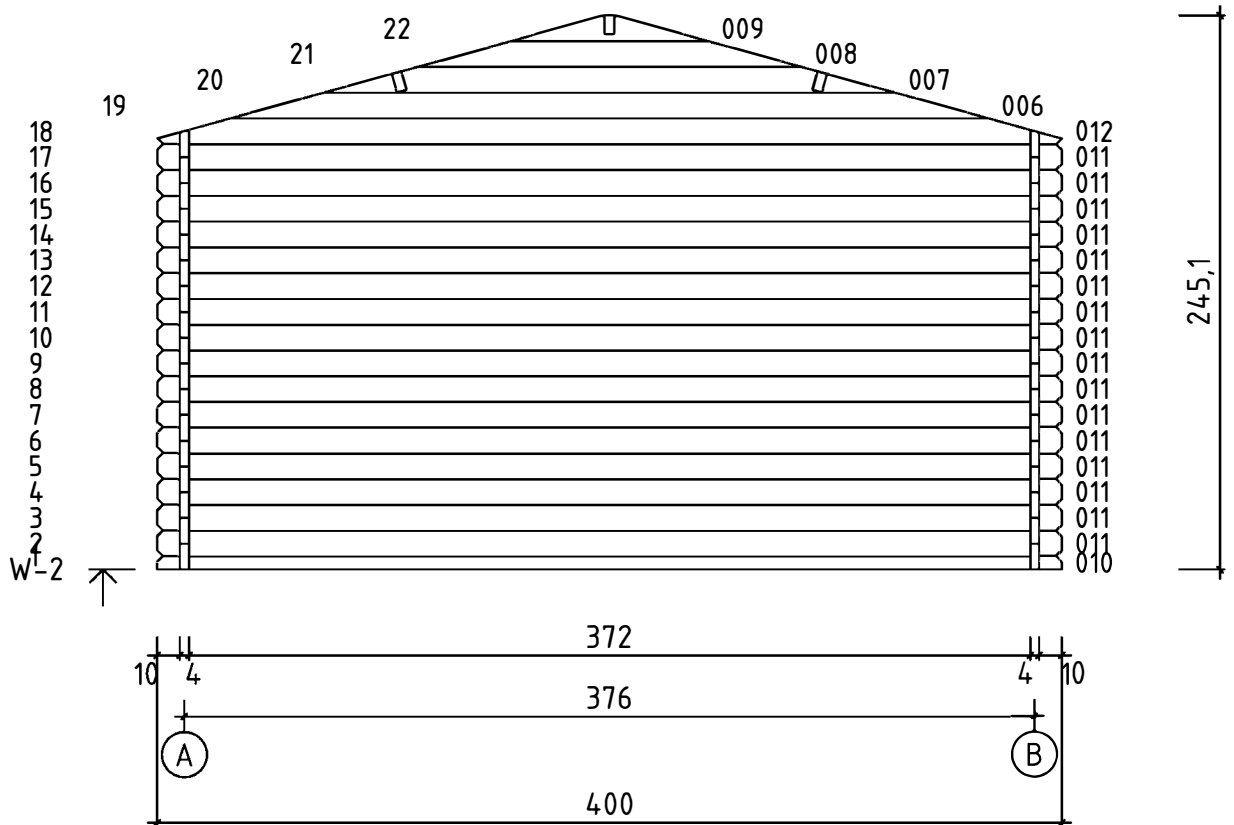

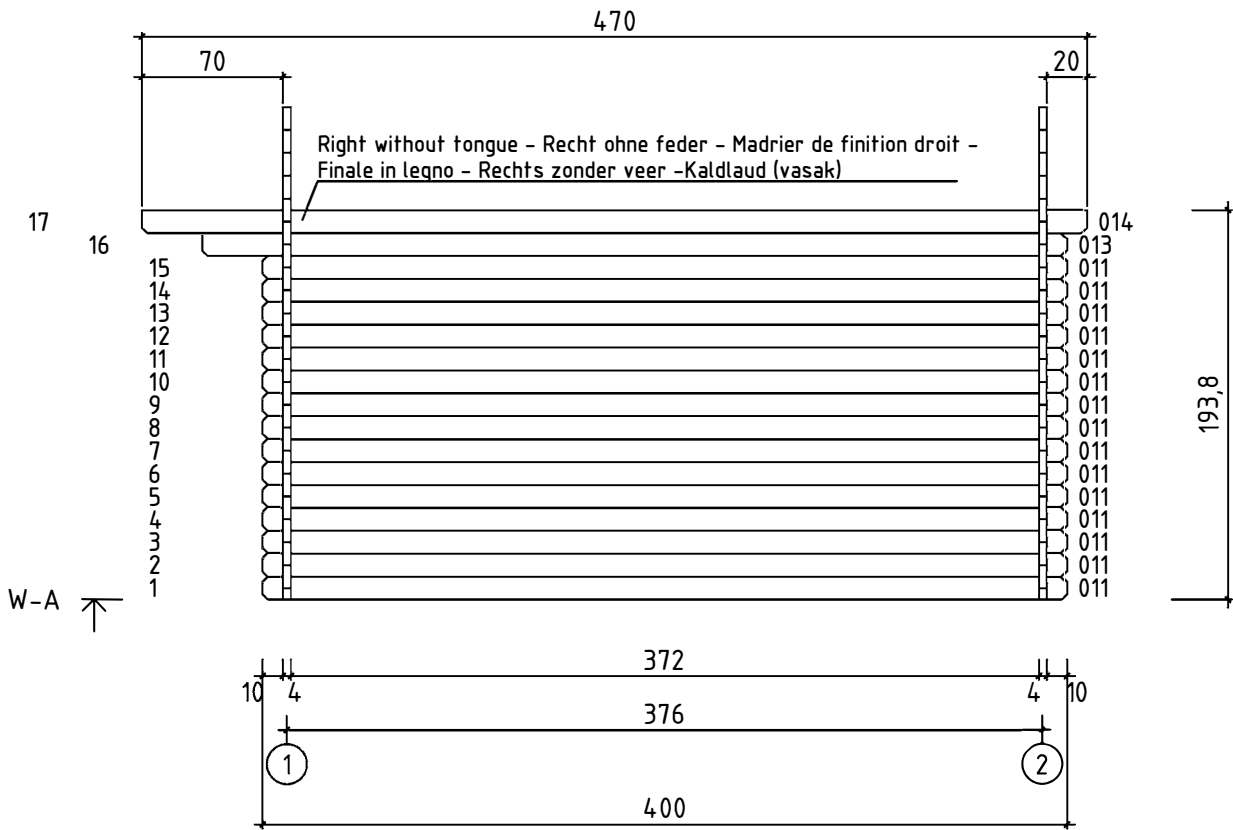

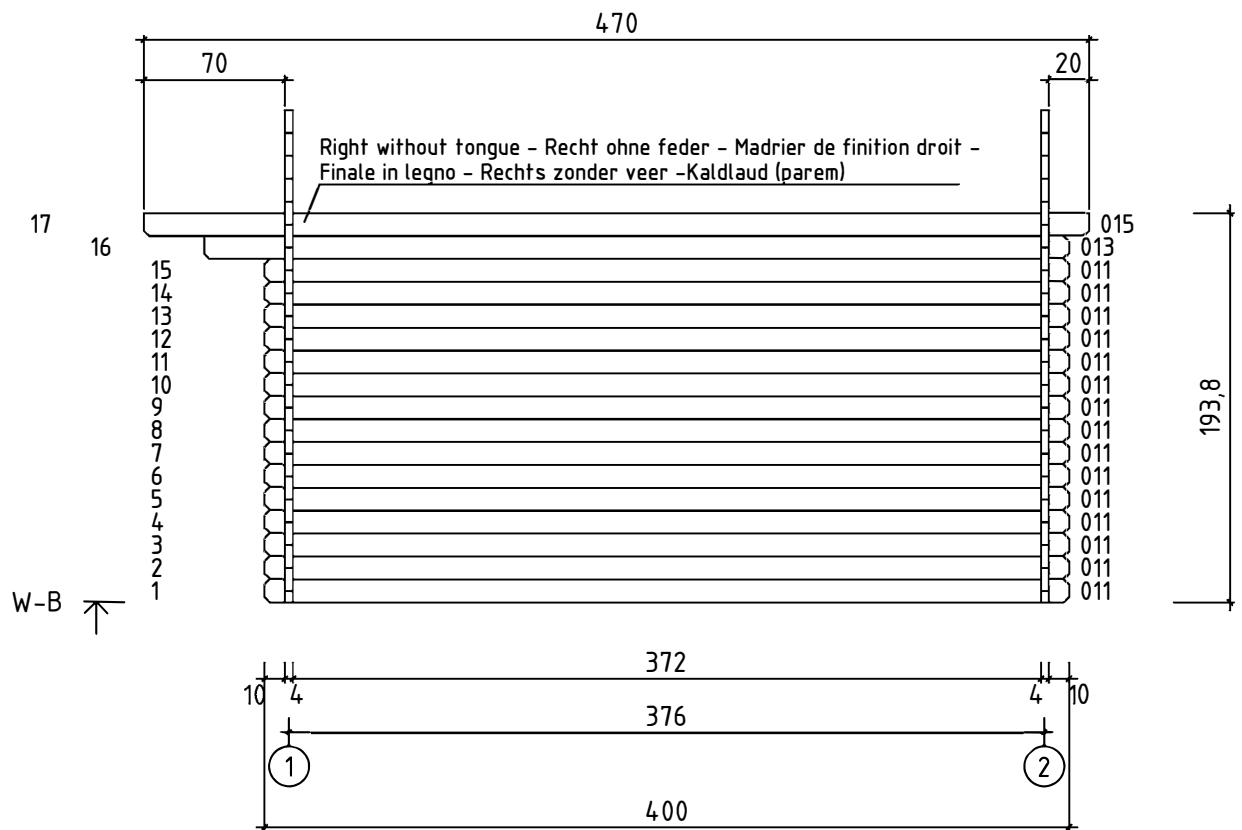

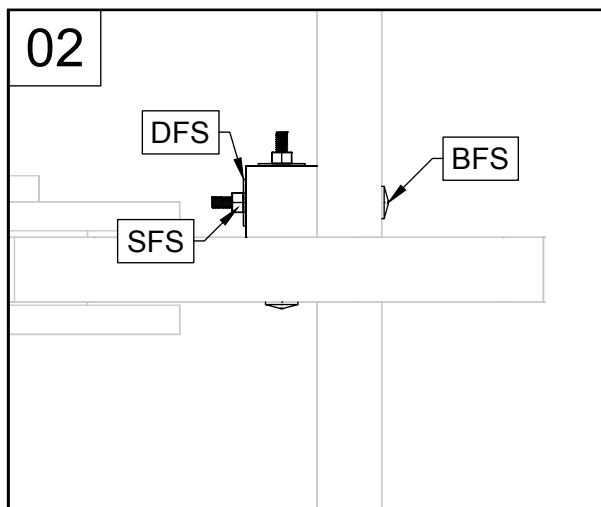
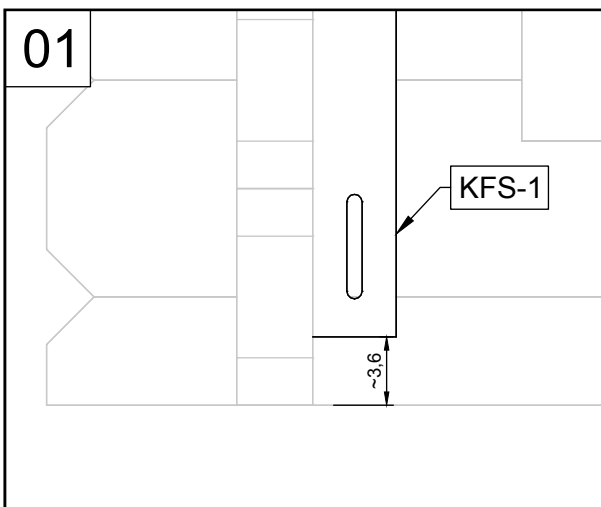
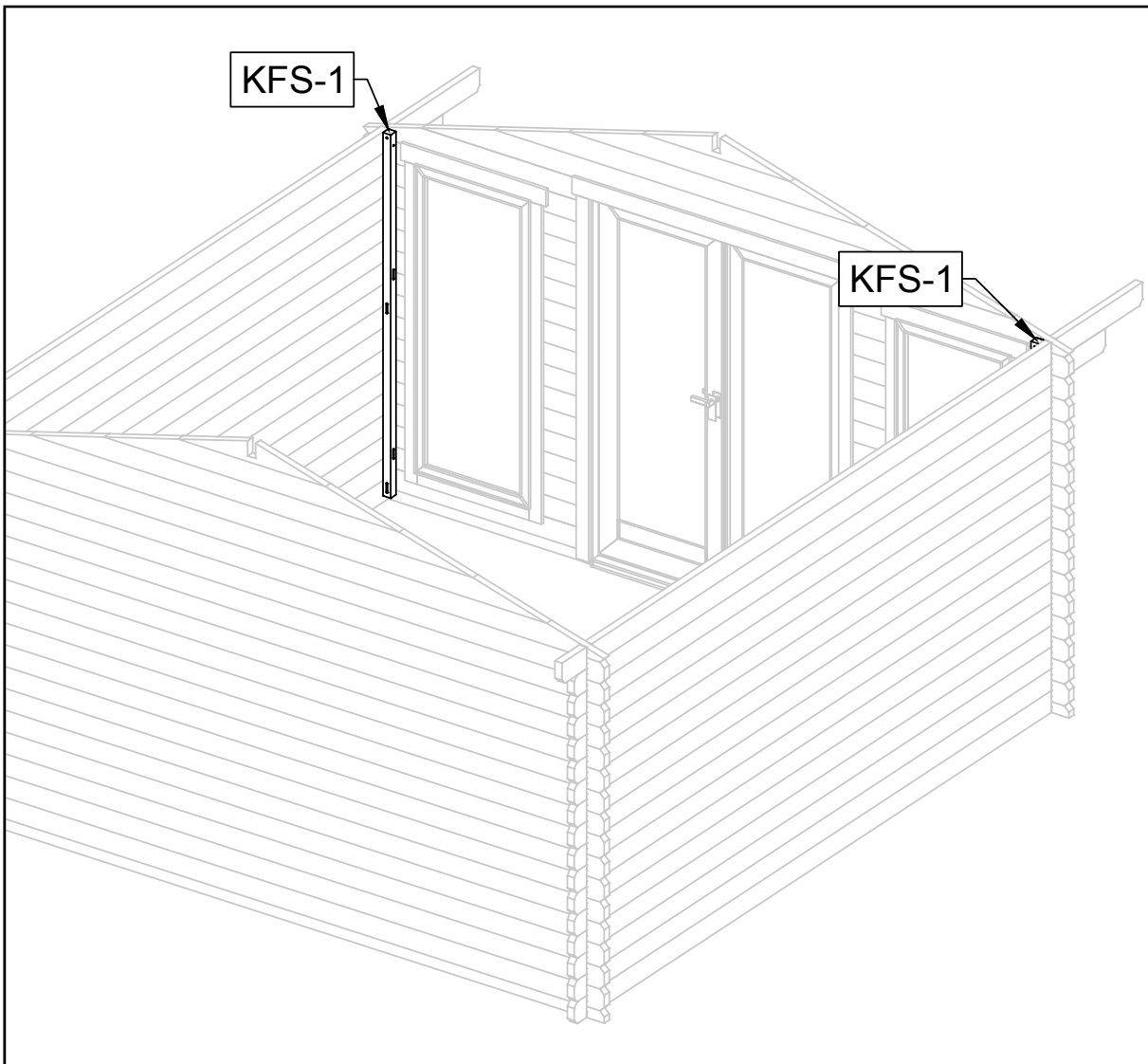

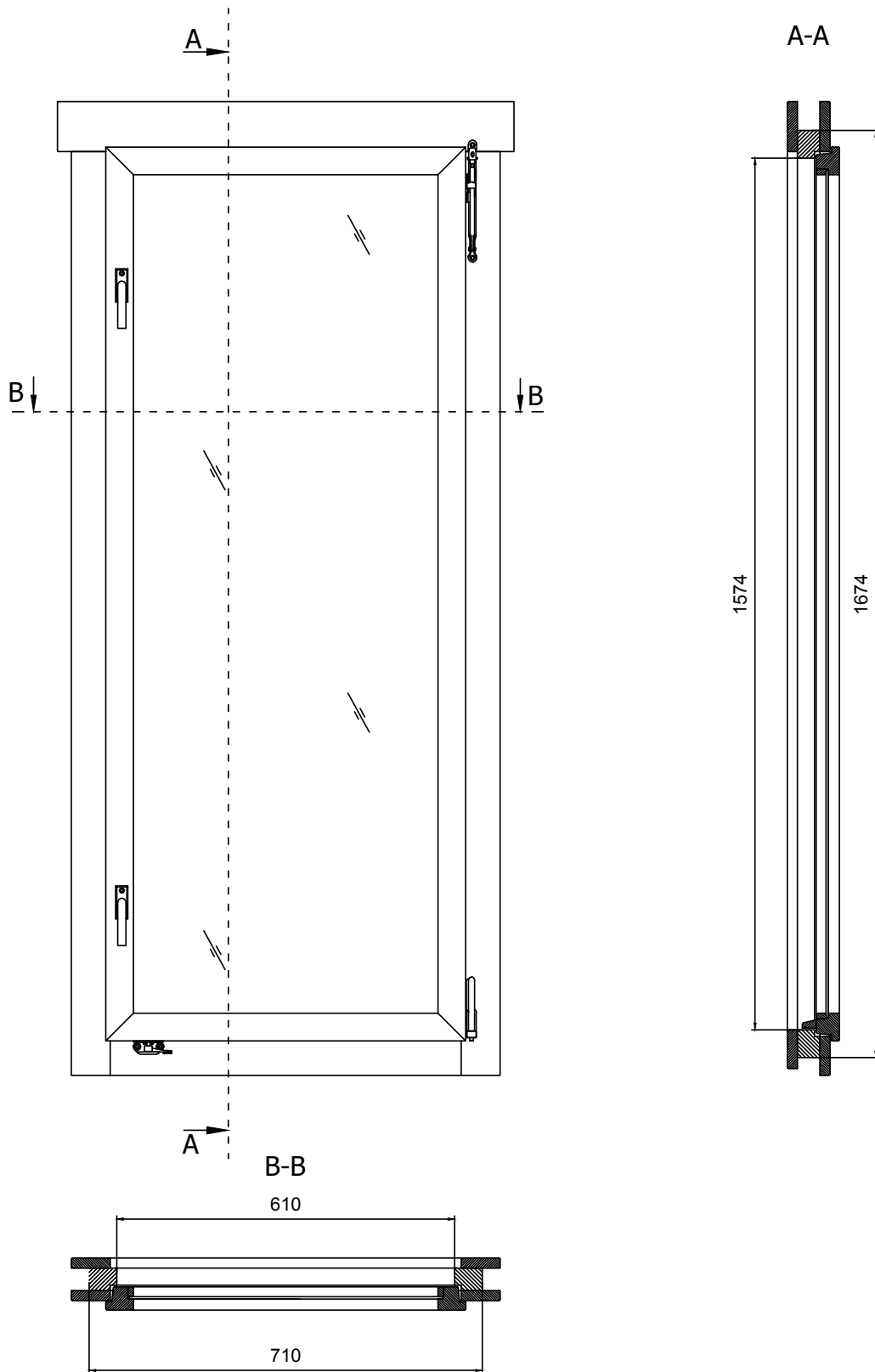

Glass size - Glasgröße - Taille de la vitre - Misura del vetro - Glas afmeting -
Klaasi mõõt: 566x1530 mm

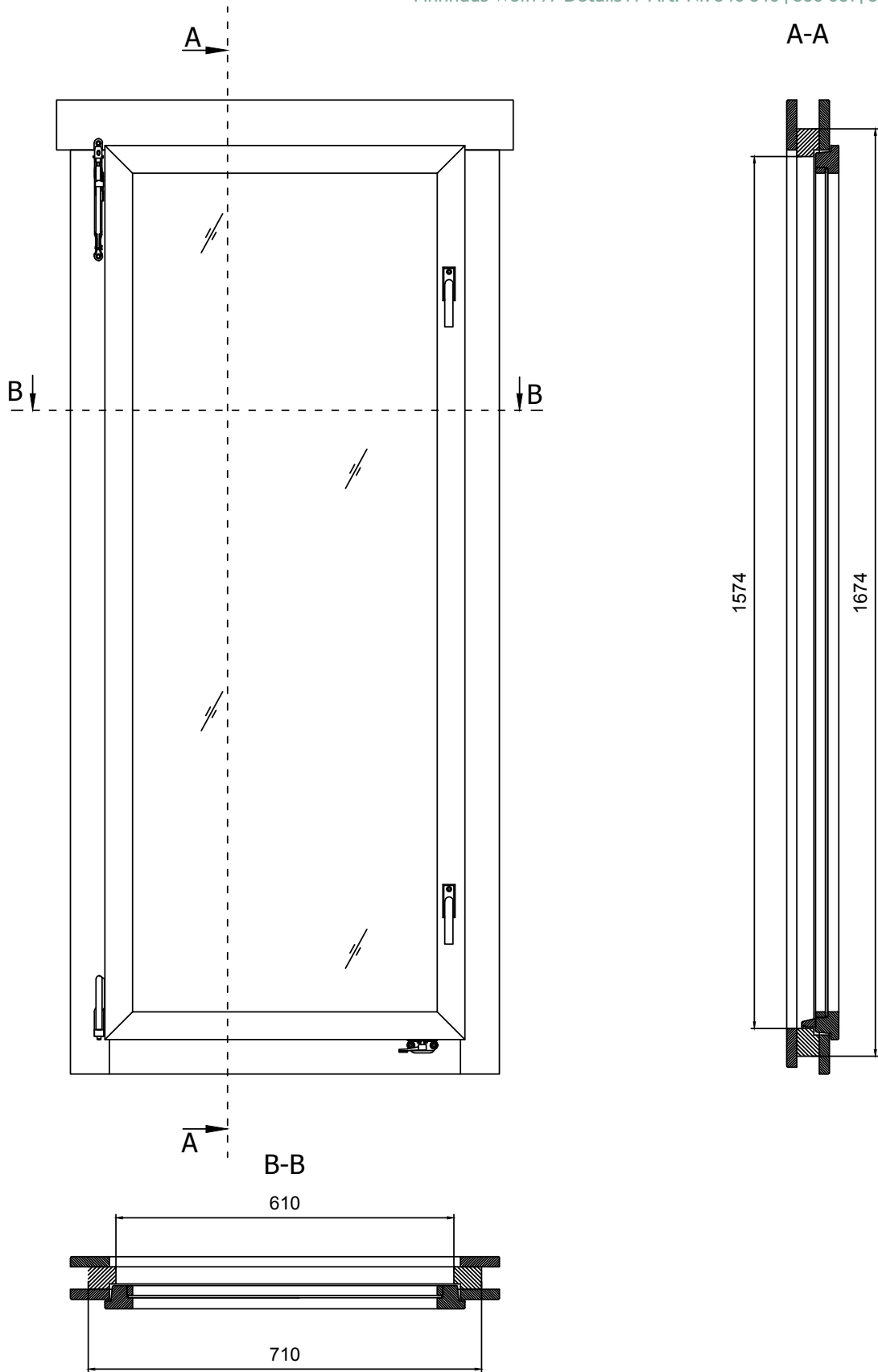

Glass size - Glasgröße - Taille de la vitre - Misura del vetro - Glas afmeting -
Klaasi mõõt: 566x1530 mm

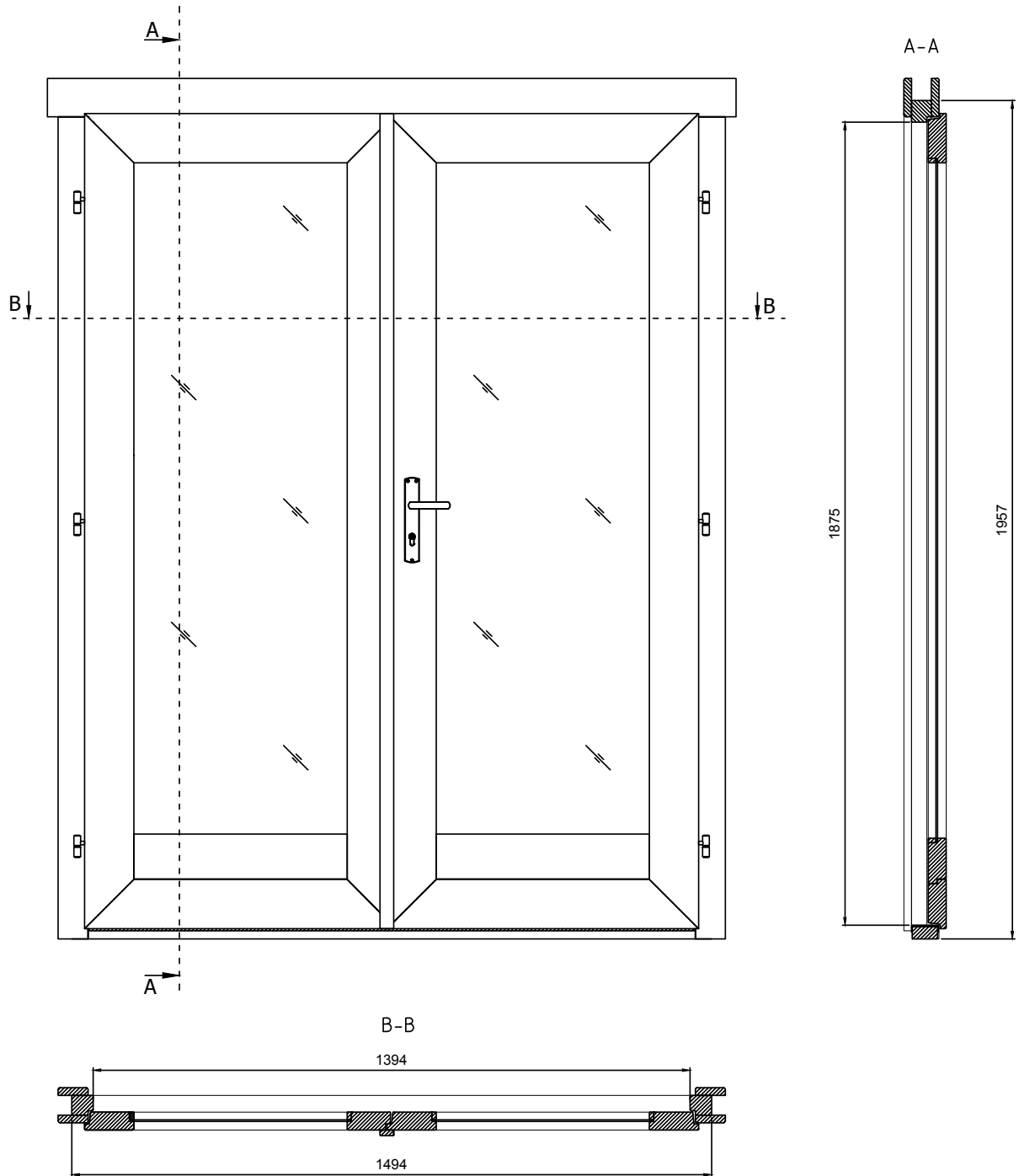

Glass size - Glasgröße - Taille de la vitre - Misura del vetro - Glas afmeting -
 Klaasi mõõt: 566x1530 mm