

Technische Daten: Art.-Nr.: 870500

Wandaußenmaß: 360 x 300 cm

Bohlenstärke: 70 mm



Kontrolliert durch:

Empty box for signature or name.

Achtung: Alle angegebenen Maße sind ca.-Maße!

3D-Darstellung und Grundriss 870500

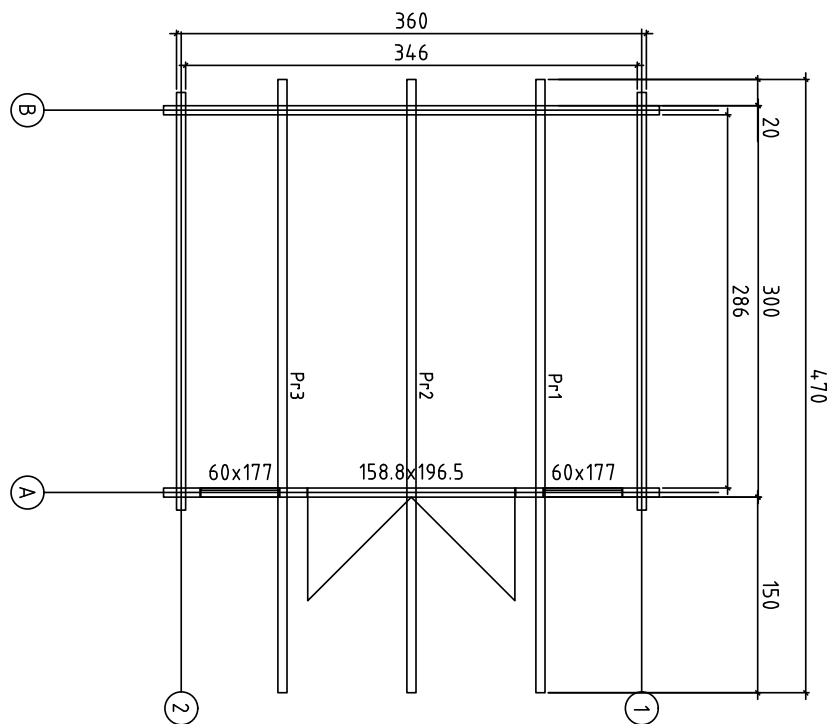
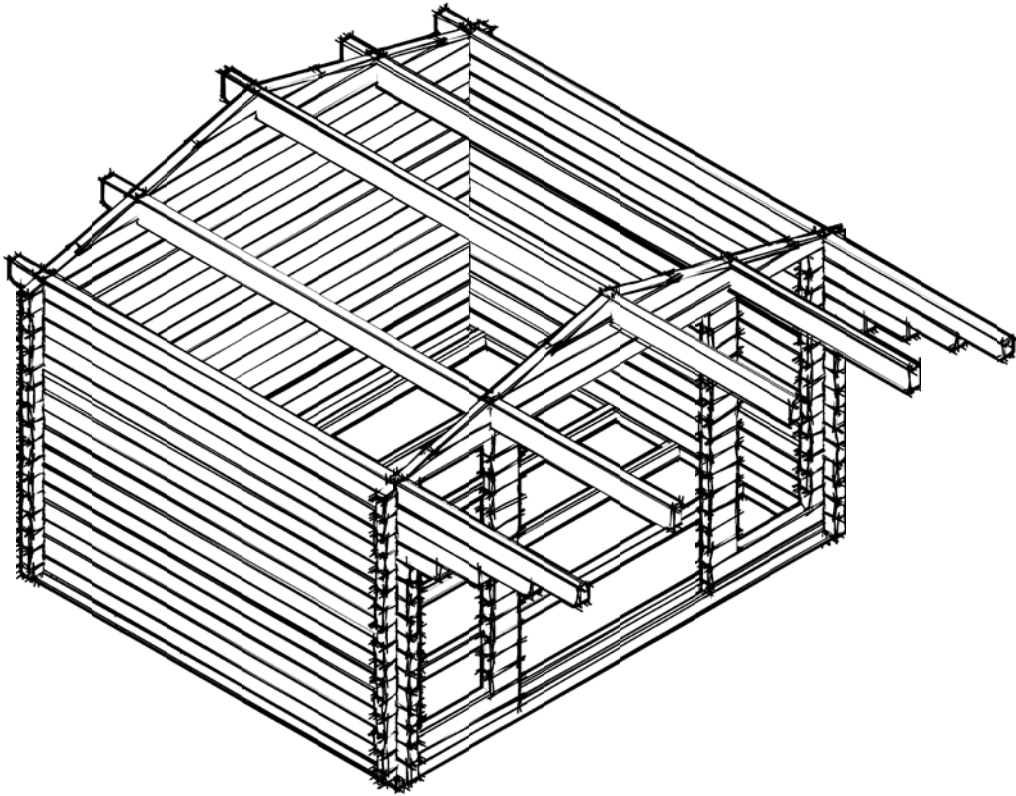





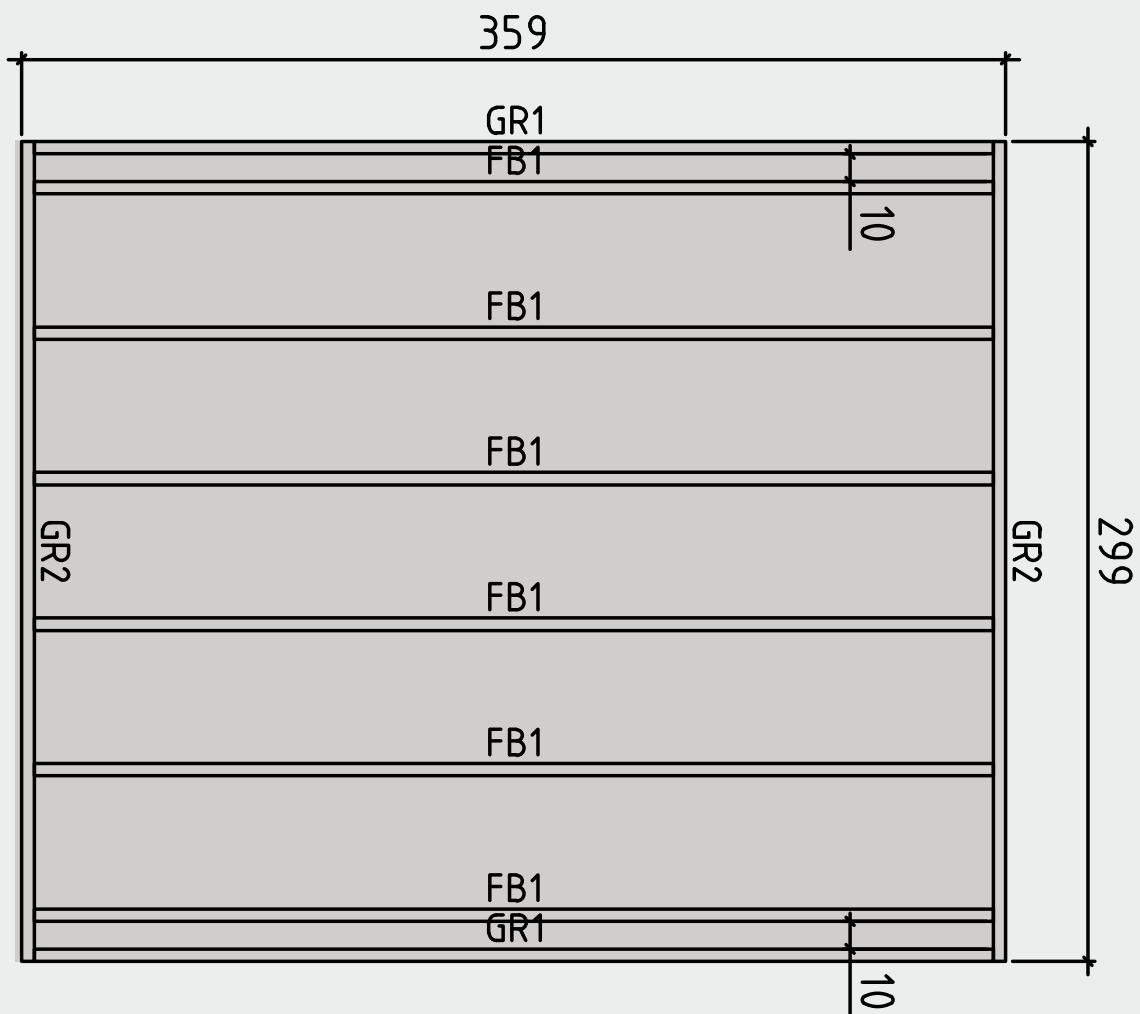





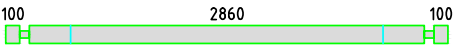

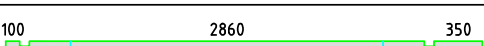
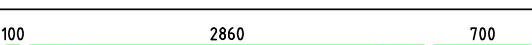
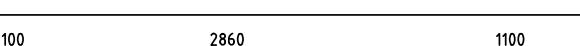
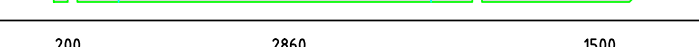
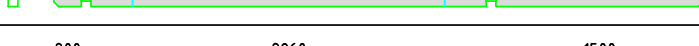

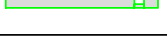
Lagerholzplan und Fundamentplan 870500

Wir empfehlen als Fundament für Ihr Gartenhaus eine vollflächig,
festgegründete gepflasterte oder betonierte Fläche.
Wahlweise ist auch ein Punkt- oder Streifenfundament möglich.

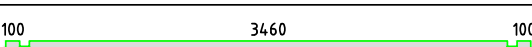
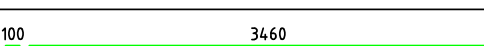
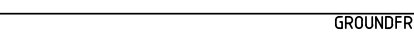
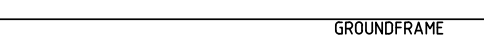

Teileliste 1

870500

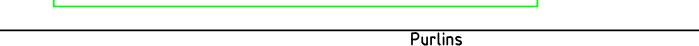
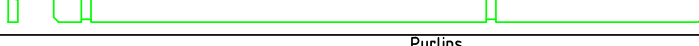
Pos		Arv	Profile (mm)	LENGHT (mm)
001		2	70x130	3200
002		2	70x130	3200
003		20	70x130	3200
004		2	70x130	3450
005		2	70x130	3800
006		2	70x130	4200
007		1	70x130	4700
008		1	70x130	4700
009		2	70x65	1101
010		2	70x130	1101
011		28	70x130	281
012		28	70x130	210
013		2	70x130	3800
014		8	70x122	464
015		2	70x130	1917
016		2	70x130	1977
017		1	70x65	3800
018		15	70x130	3800
GR1	GROUNDFRAME 	2	45x90	3500
GR2	GROUNDFRAME 	2	45x90	2990
FB1	FLOORBEAMS 	6	45x90	3500
Pr1	Purlins 	1	70x170	4700
Pr2	Purlins 	1	70x170	4700
Pr3	Purlins 	1	70x170	4700
	WINDOW 600x1770	2		

Teileliste 3

870500

Specification for Hammerfest 70 A 70x130 mm					
POS	ST.	B	H	L	Teileliste
FB1	45x90 - 10 st.				FUNDMENTHOLZER
F2	9,89 m ²	28		2855	FUSSBODENBRETTER 40/31/26
R1	3	70	170	4700	DACHBALKEN
RB1	19,92 m ²	20		2120	DACHBRETTER 122/94/78
R1	2	20	120	4700	<small>Vapto kattse kälreni rka</small> Traufenbretter
R2	2	45	65	4700	<small>Vapto kattse kälreni rka</small> Traufenbretter
R3	4	20	120	2300	<small>Vapto kattse kälreni rka</small> Giebelabschlussleiste
R4	4	20	90	2300	Giebelabschlussleiste
WN06	2	600	1770		<p>Sliding slats 30x30x1700 mm - 6 pcs.</p>
DR16	1	1588	1965		
P1	14 m	20	40		Fußbodenleiste
P2	4	20	90	1945	Türleiste DR 16
P3	4	20	90	900	Fensterleiste WN 06
P4	10	20	90	1890	Türleiste DR 16
P6	2+2	20	90	540 570	Fensterleiste WN06

Detailzeichnungen 870500

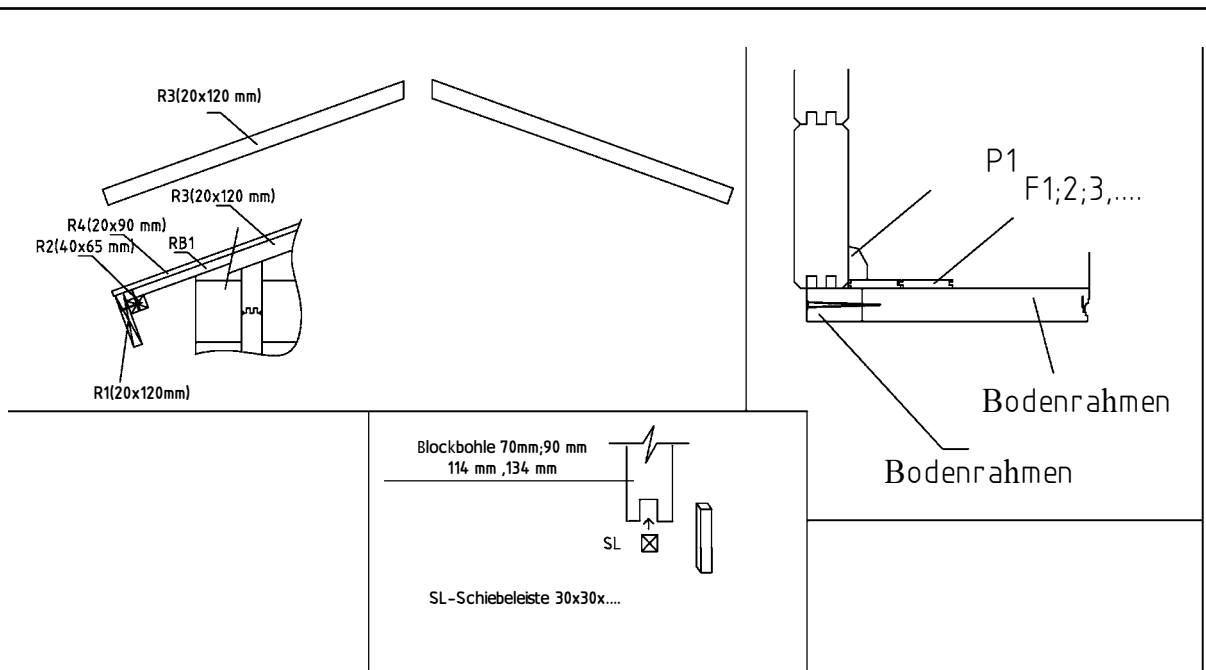

Dichtungssystem der Blockbohlen

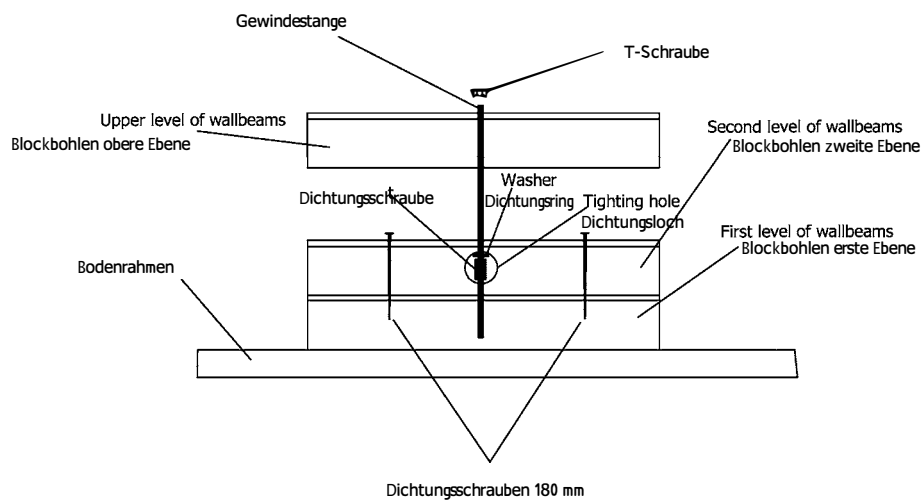

Wandplan 1 und 2 870500

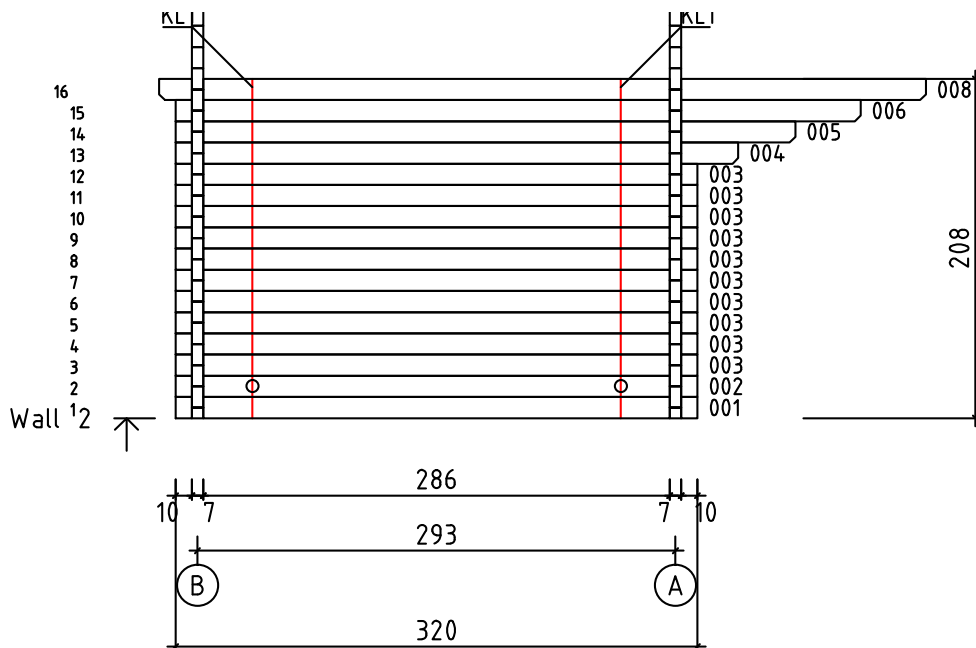
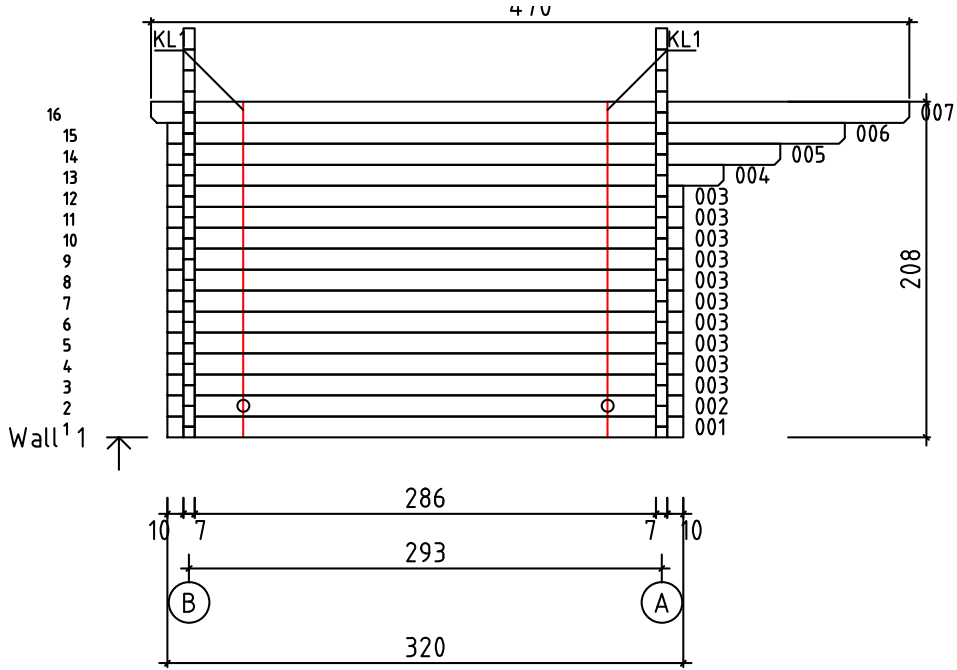

Wandplan A 870500

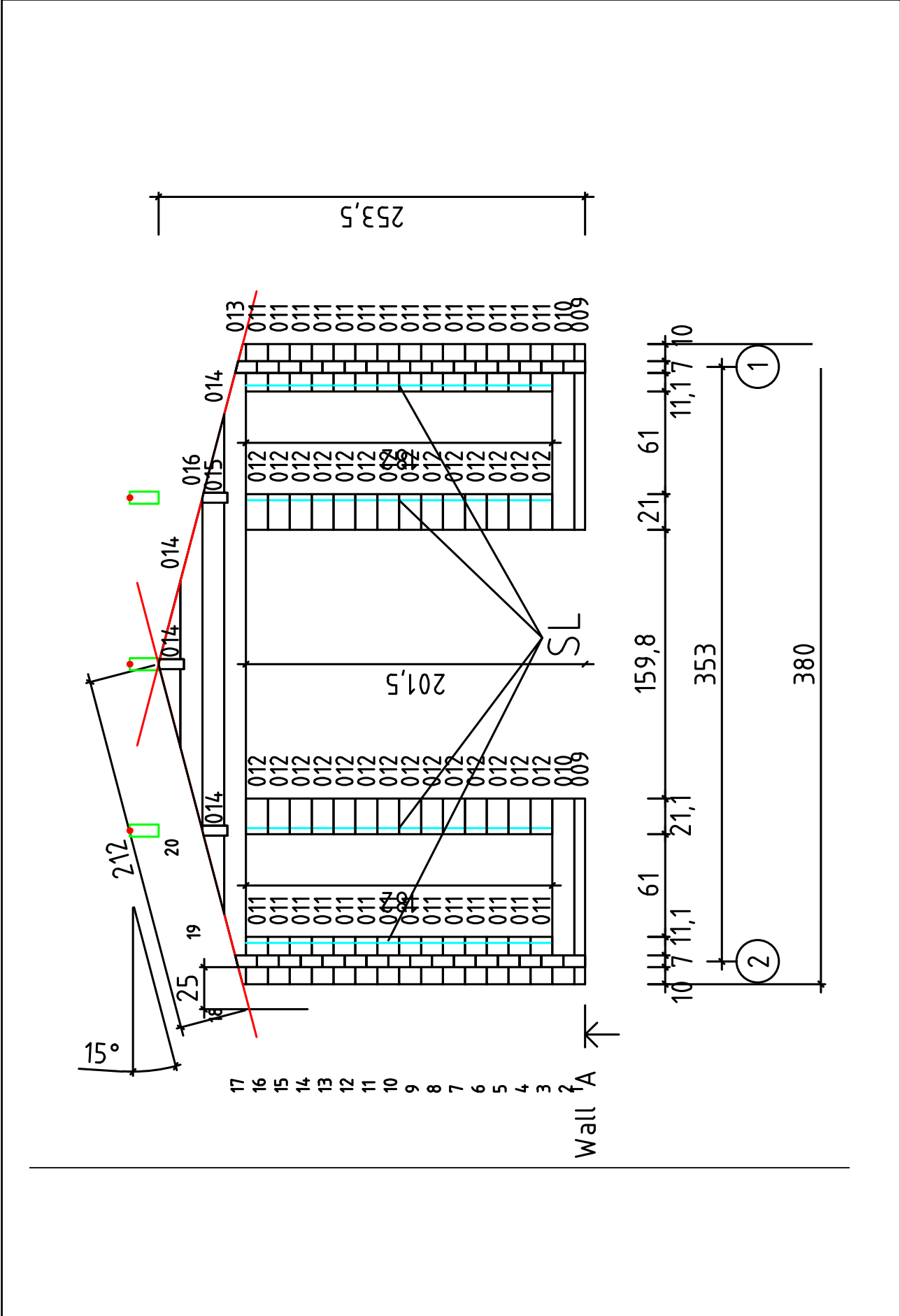

Wandplan B 870500

