

Lisa 44-C

Wandaußenmaß: 390 x 390 cm

Bohlenstärke: 44 mm



Kontrolliert durch:

Achtung: Alle angegebenen Maße sind ca.-Maße!

3D-Darstellung Lisa 44-C

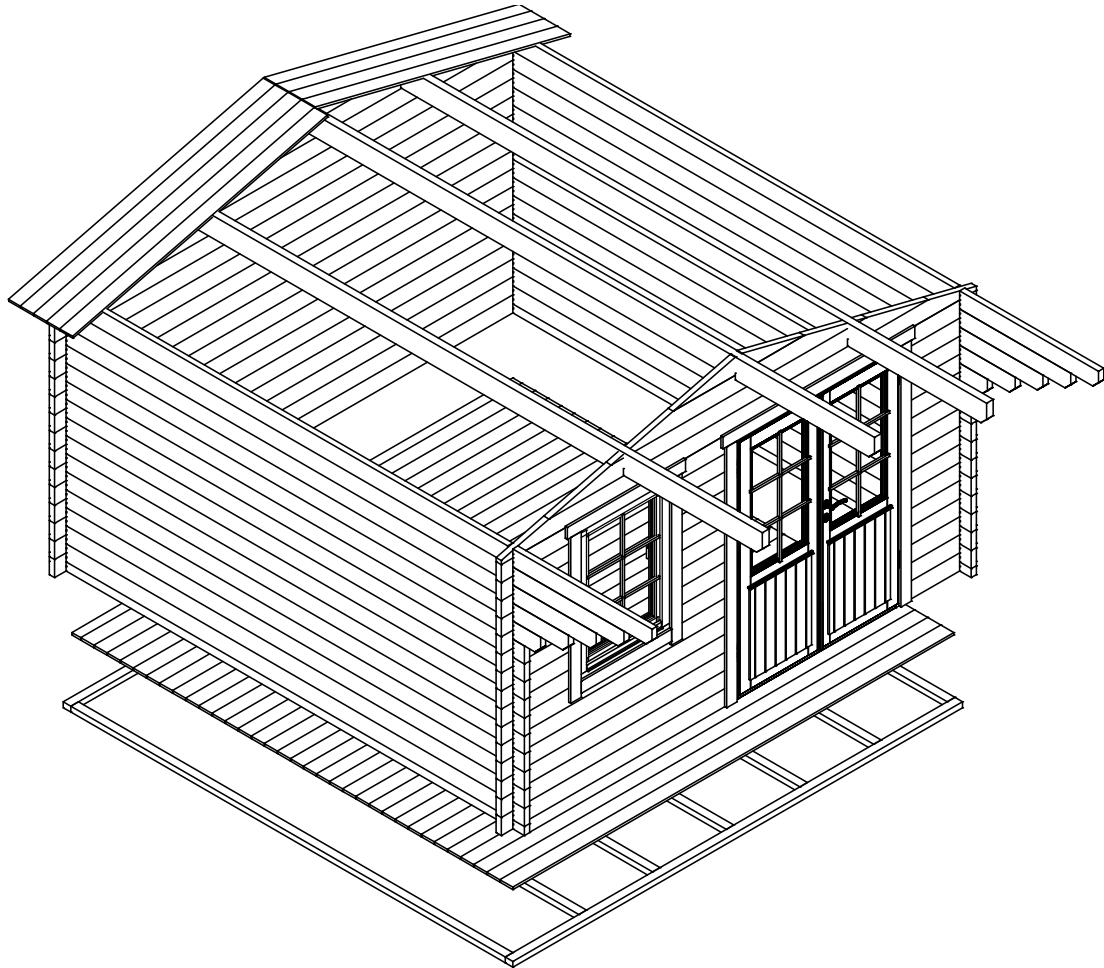

Grundriss Lisa 44-C

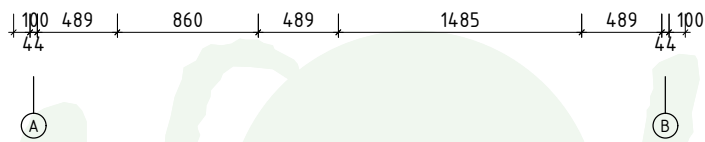
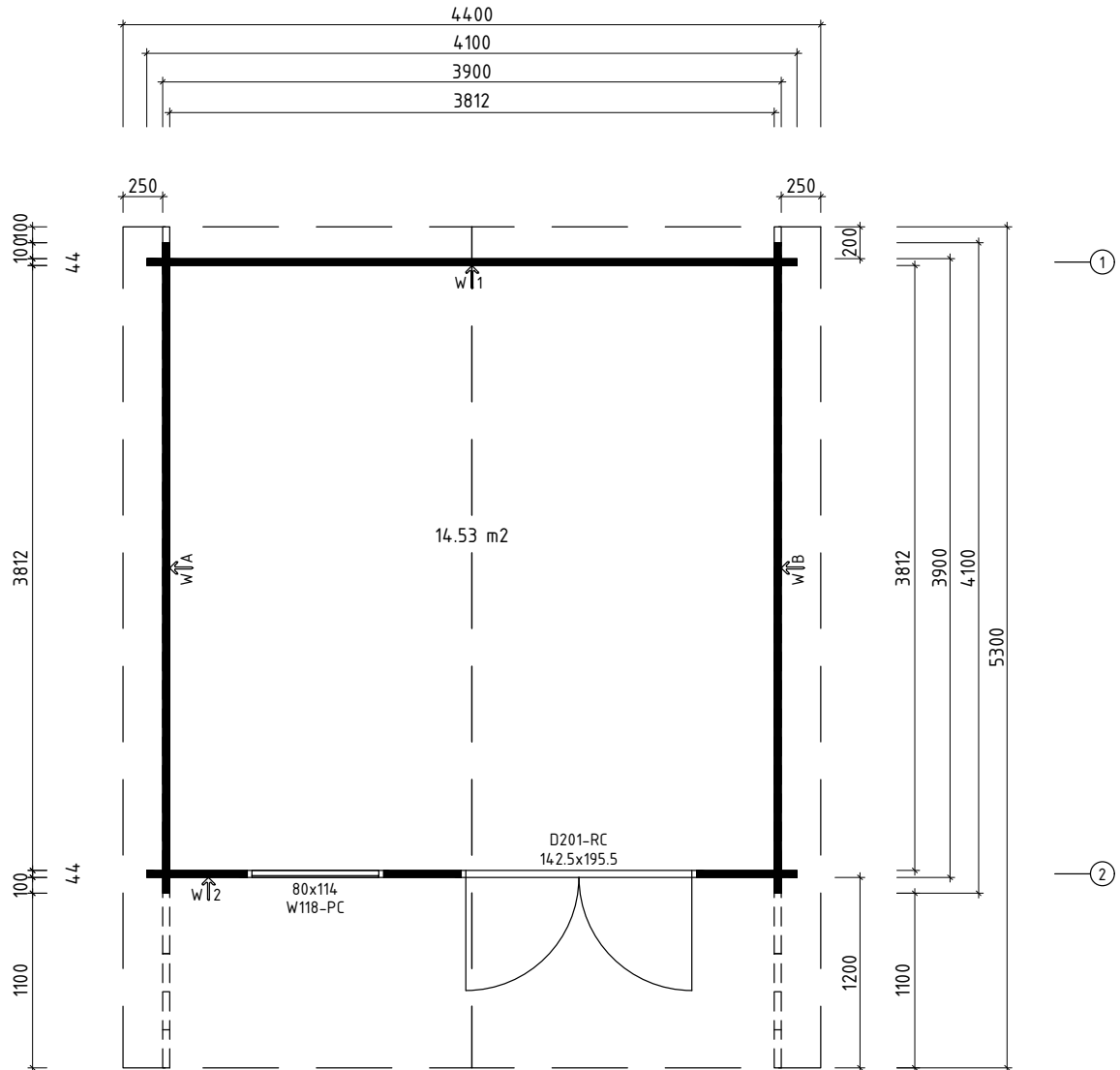

Q4 – Qualitätsklasse für Fenster und Türen

* Fenster und Türen sind mit Sprossen





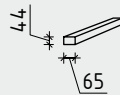
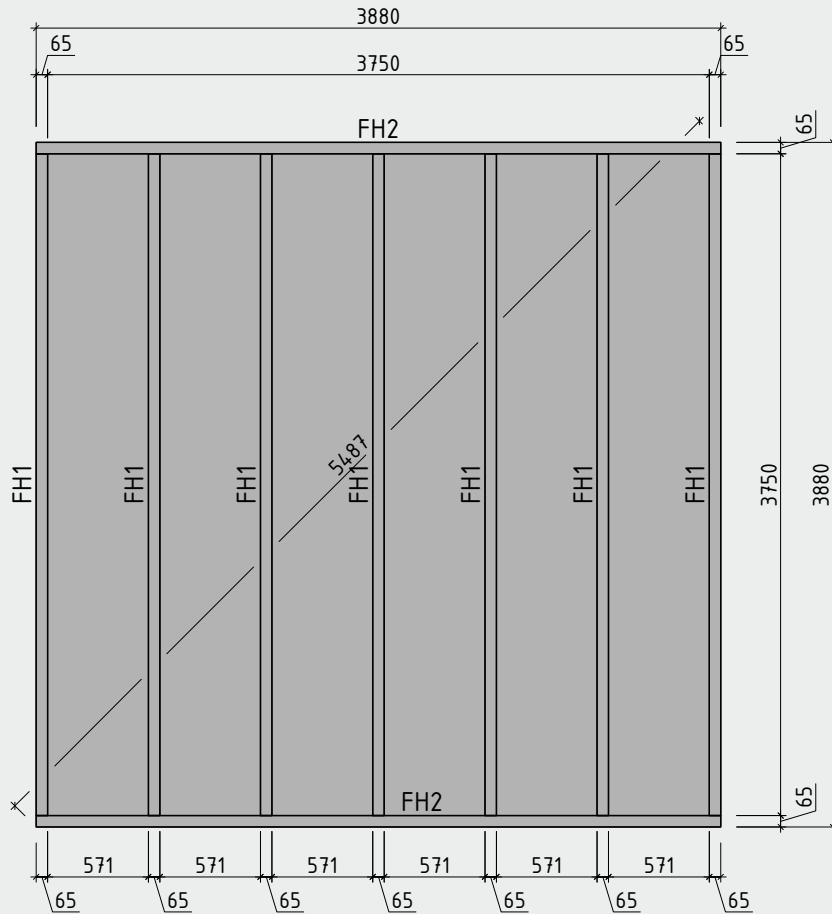





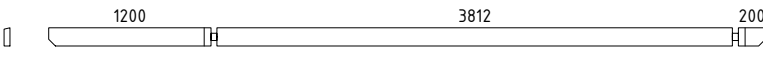
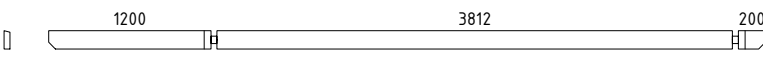
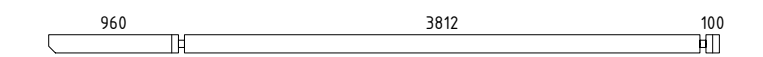
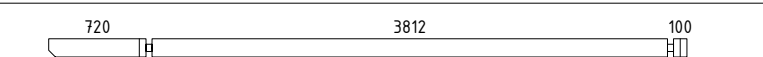
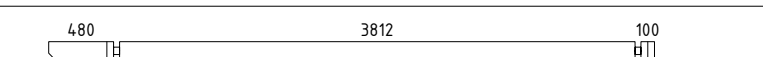
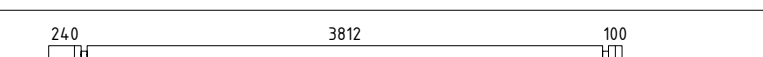
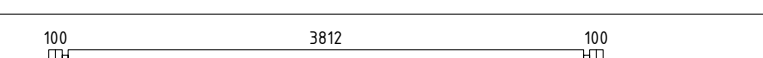
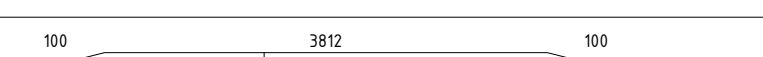

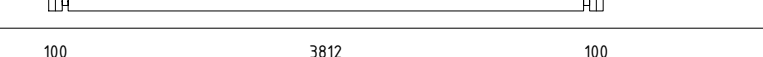
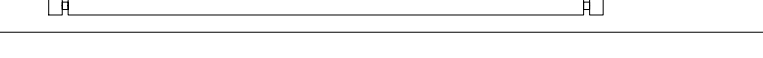
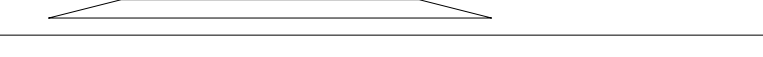

Lagerholzplan und Fundamentplan Lisa 44-C

Wir empfehlen als Fundament für Ihr Gartenhaus eine vollflächig,
festgegründete gepflasterte oder betonierte Fläche.
Wahlweise ist auch ein Punkt- oder Streifenfundament möglich.





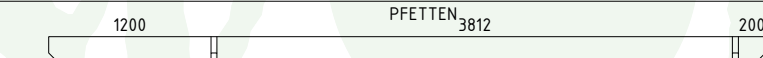











Teileliste 1

Lisa 44-C

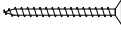
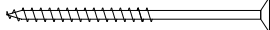
Pos		Stck.	Profil (mm)	Länge (mm)
001		1	44x135	5300
002		1	44x135	5300
003		2	44x135	4960
004		2	44x135	4720
005		2	44x135	4480
006		2	44x135	4240
007		2	44x68	4100
008		1	44x135	4100
009		1	44x135	4100
010		20	44x135	4100
011		15	44x135	4100
012		2	44x135	3276
013		2	44x135	2203
014		5	44x135	1982
015		1	44x135	1982
016		24	44x135	633
017		4	44x135	541
018		7	44x135	489
019		2	44x135	489
FH2	FUNDAMENTHÖLZER (imprägniert) 	2	65x44	3880
FH1	FUNDAMENTHÖLZER (imprägniert) 	7	65x44	3750
PF1	PFETTEN 	3	58x170	5300
	DACHBRETTER 	94+1	113x18	2270
	FUSSBODENBRETTER 	34+1	113x18	3805
	FUSSBODENLEISTEN 		18x40	16,0 lfdm

Teileliste 2

Lisa 44-C

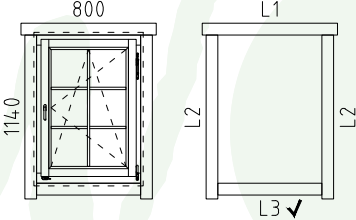
Pos		Stck.	Profil (mm)	Länge (mm)
G02-1	GIEBELBRETTER 18x120  14,1° ✓	4	18x120	2350
G06-1	GIEBELDECKLEISTEN 18x58  ✓	4	18x58	2350
T01-1	TRAUFENBRETTER 18x95 	2	18x95	5300
T06-1	TRAUFENLEISTEN 18x40  ✓		18x40	11,0 lfdm
GS	Giebelsegment 	2		
ML1	Metallstange 	1	D10	900
ML2	Metallstange 	1	D10	770
NG04	NÄGEL 2.5x50 Dachbretter Fussbodenbretter 	1040		
SR32	SCHRAUBEN 3.0x30 Fussbodenleiste Traufenleiste 18x40 	54		
SR37	SCHRAUBEN 3.5x45 Giebelbretter 18x120, Giebeldeckleisten 18x58 Giebelsegment, Traufenbretter 18x95 Tür- und Fensterleisten 	116		
SR57	SCHRAUBEN 5.0x100 Fundamenthölzer 	36		
SH	Schlaghölzer 	3		
KL1	Gewindestange M8 	4		2000
KL2	Gewindestange M8 	4		123
	Mutter M8 	8		
	U-Scheibe M8 Ø25 	8		
	Befestigungsmutter M8 	4		
	FENSTER <u>Q4</u> W4-S44P-06C-08001140  A58-3/W118-PC L1 18x90 L=1040mm 2x L2 18x90 L=1260mm 4x L3 18x90 L=800mm 2x ✓	1		

Teileliste 3

Lisa 44-C

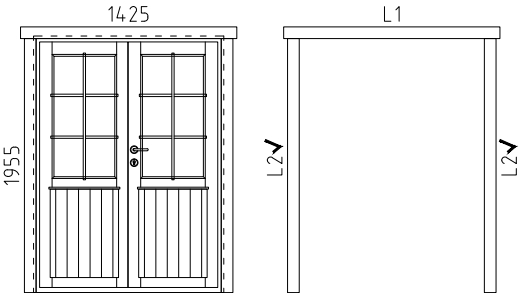
Pos		Stck.	Profil (mm)	Länge (mm)
	<p>TÜR Q4</p> <p style="text-align: right;">D4-D44R-56C-14251955</p>  <p>TU3-SH/D201-RC</p> <p>L1 18x90 L=1665mm 2x L2 18x90 L=1955mm 4x ✓</p> <p>DIN rechts</p>	1		
	✓ - bitte selber anpassen (falls nötig)!			

Wandplan 1 und 2 Lisa 44-C

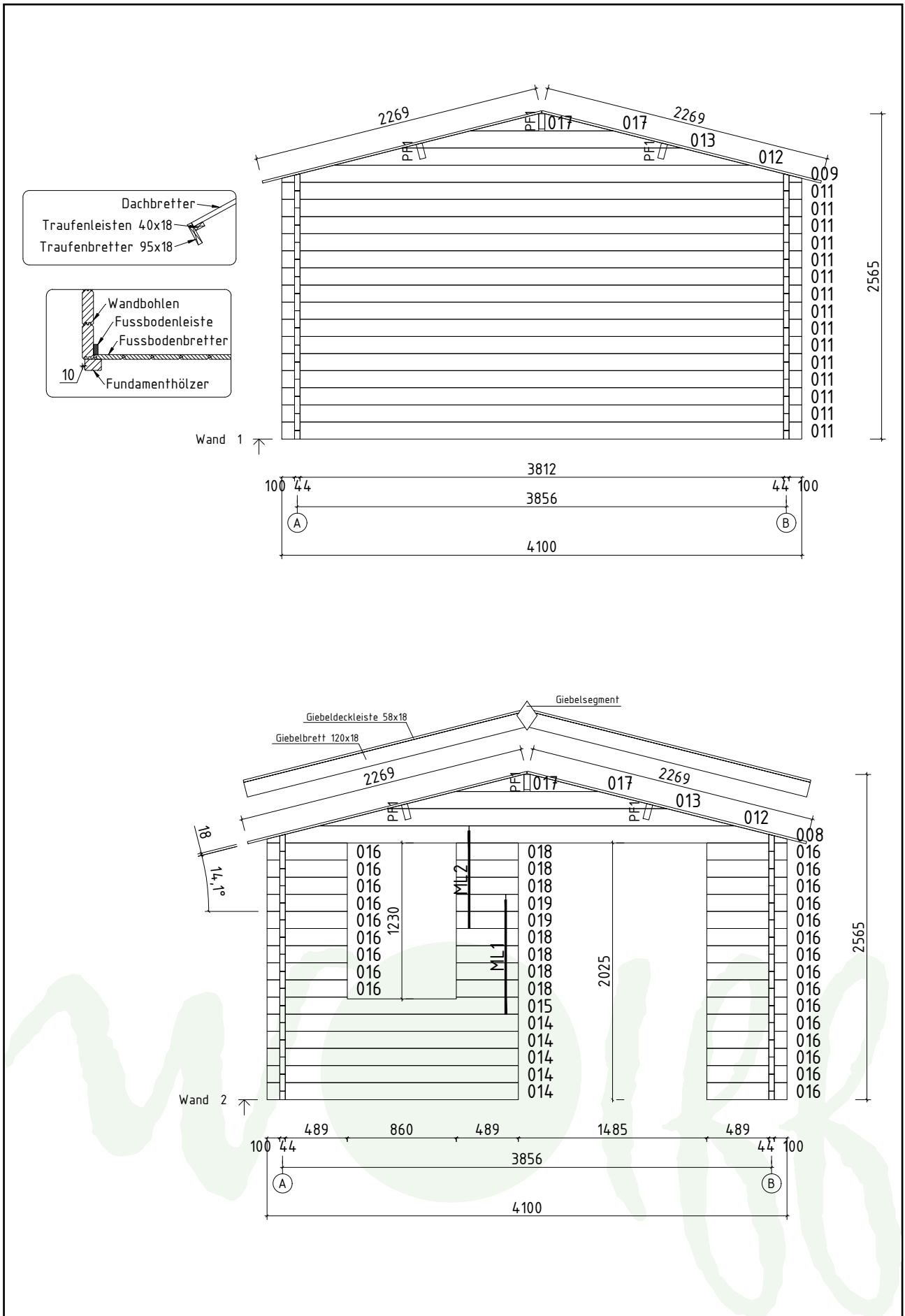

Wandplan A und B Lisa 44-C

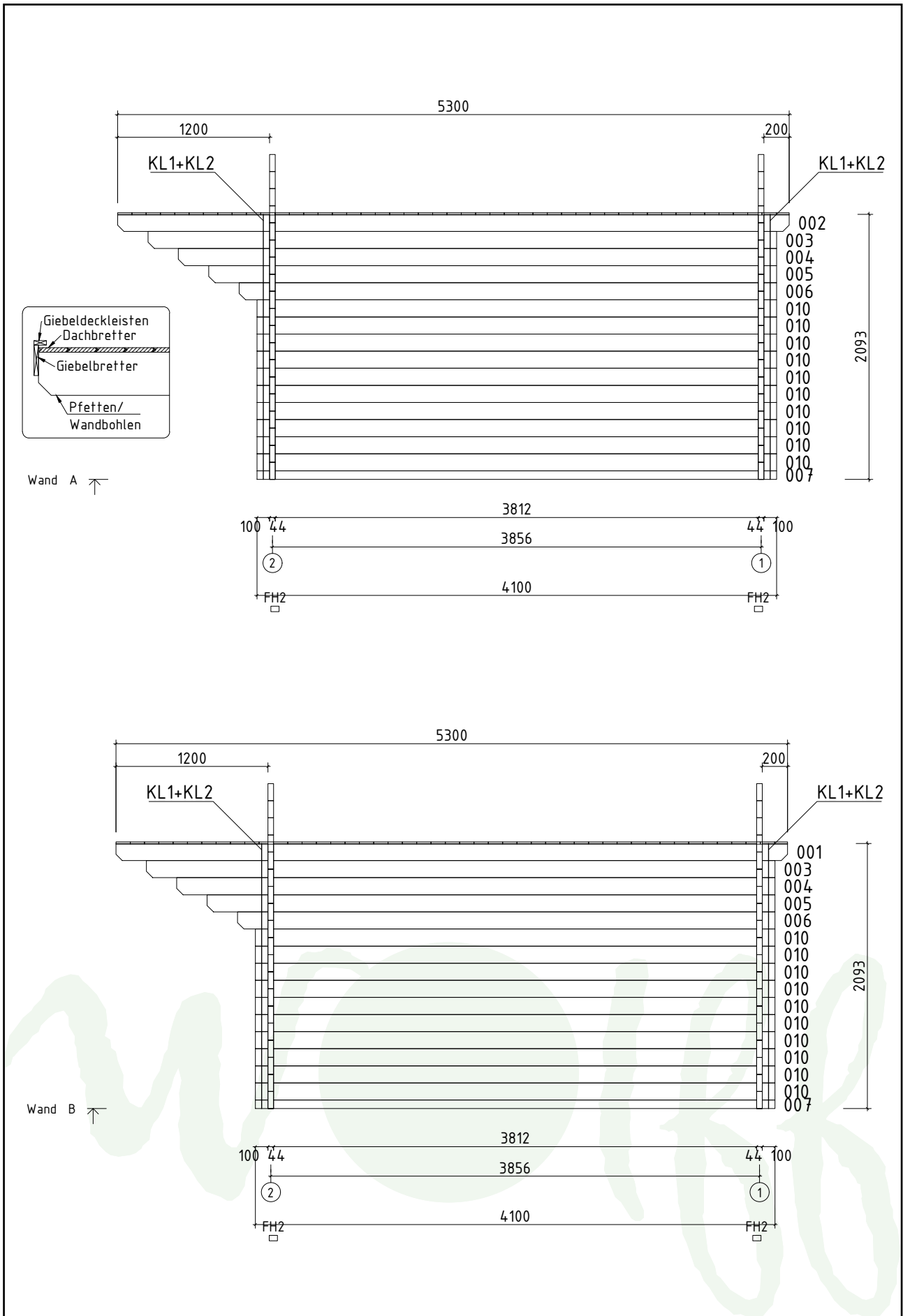

Details

Lisa 44-C

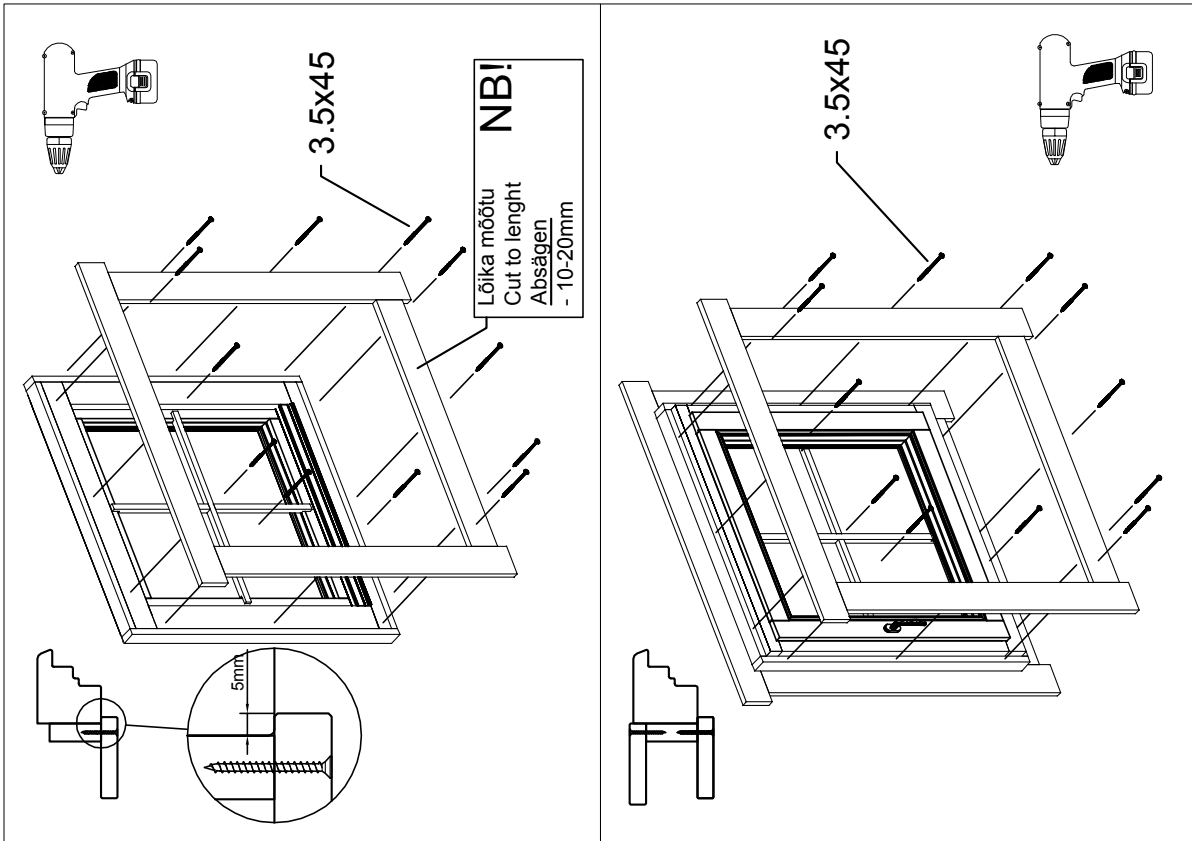

Akna tüüp / Fenster typ / Window type - A68
(GH+ / SH)

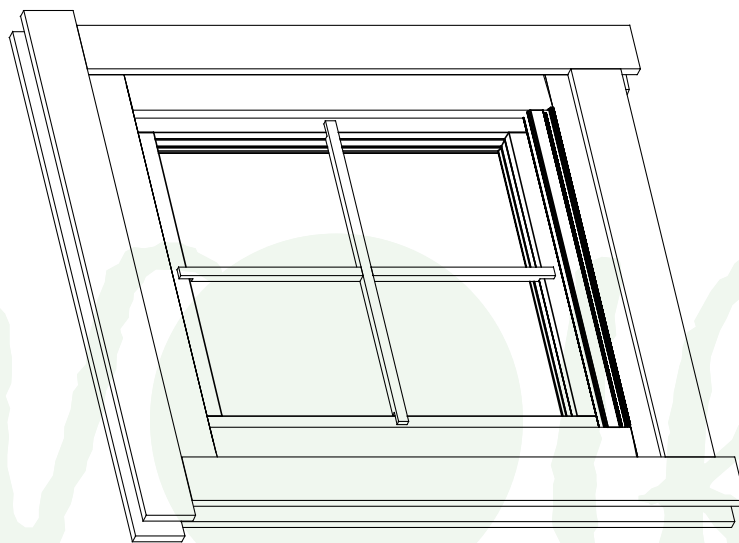

Details

Lisa 44-C

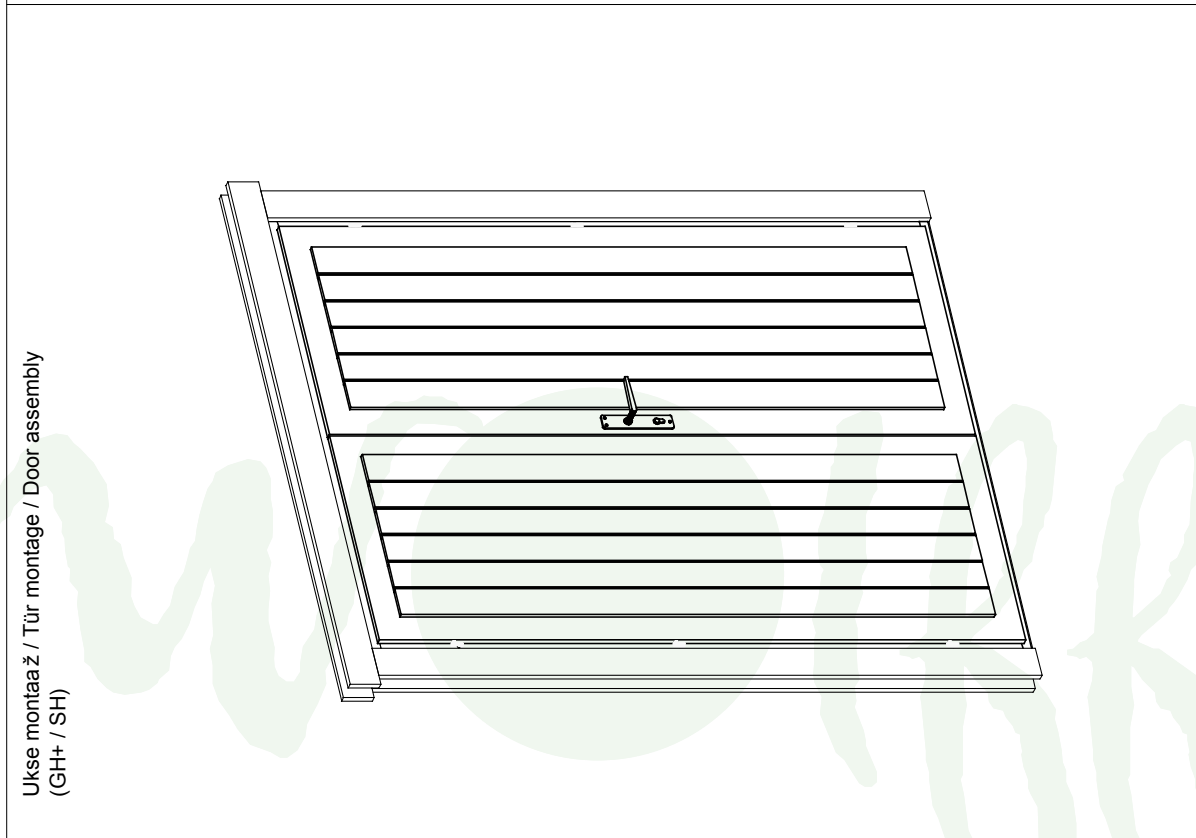
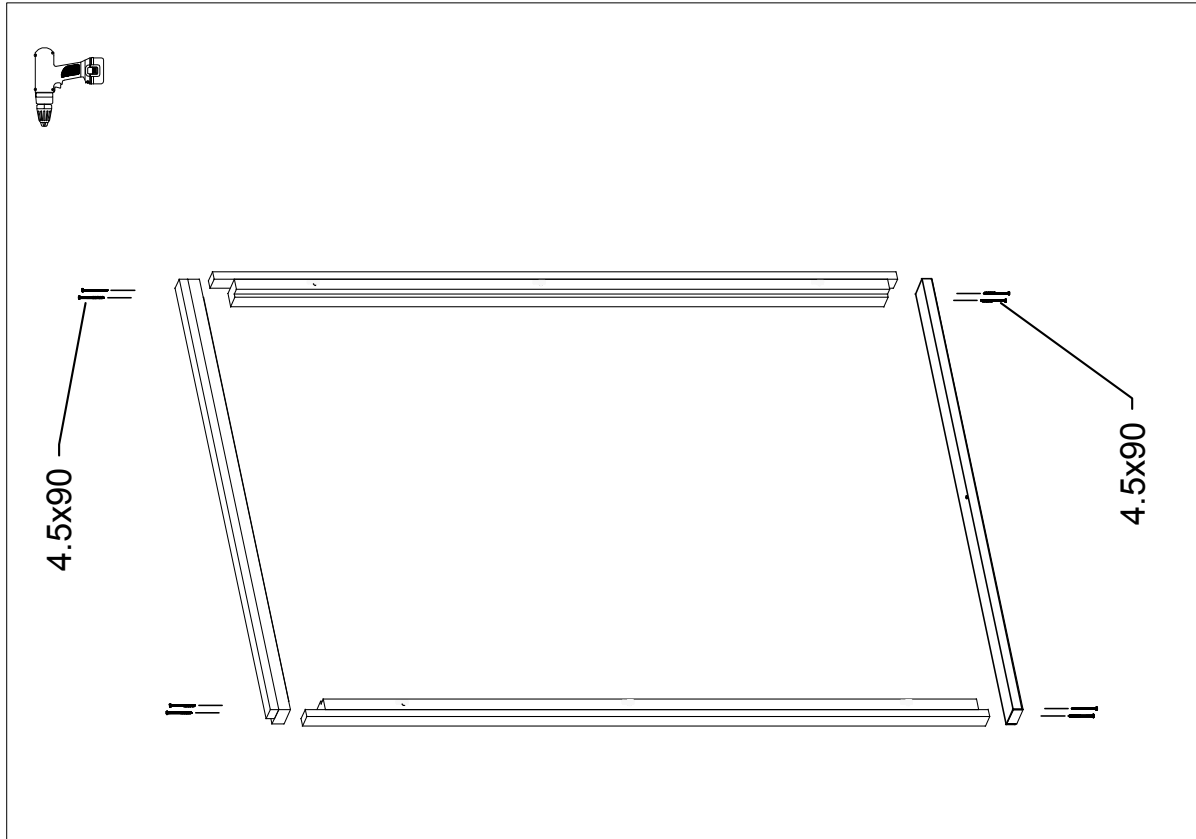

Details Lisa 44-C

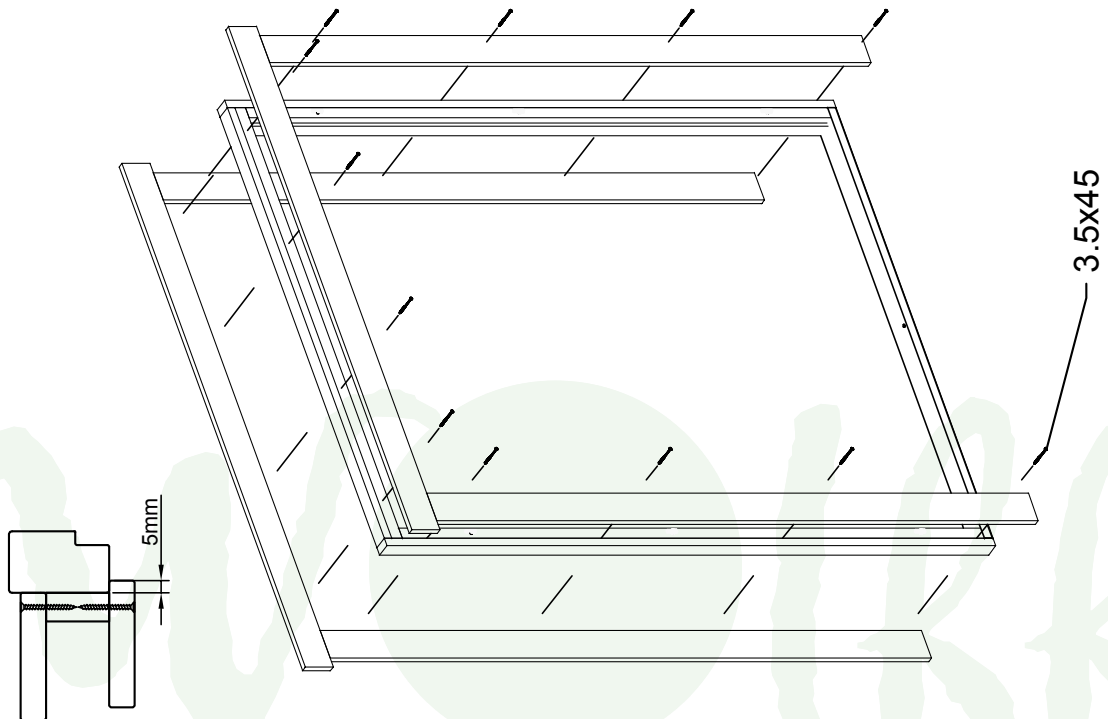
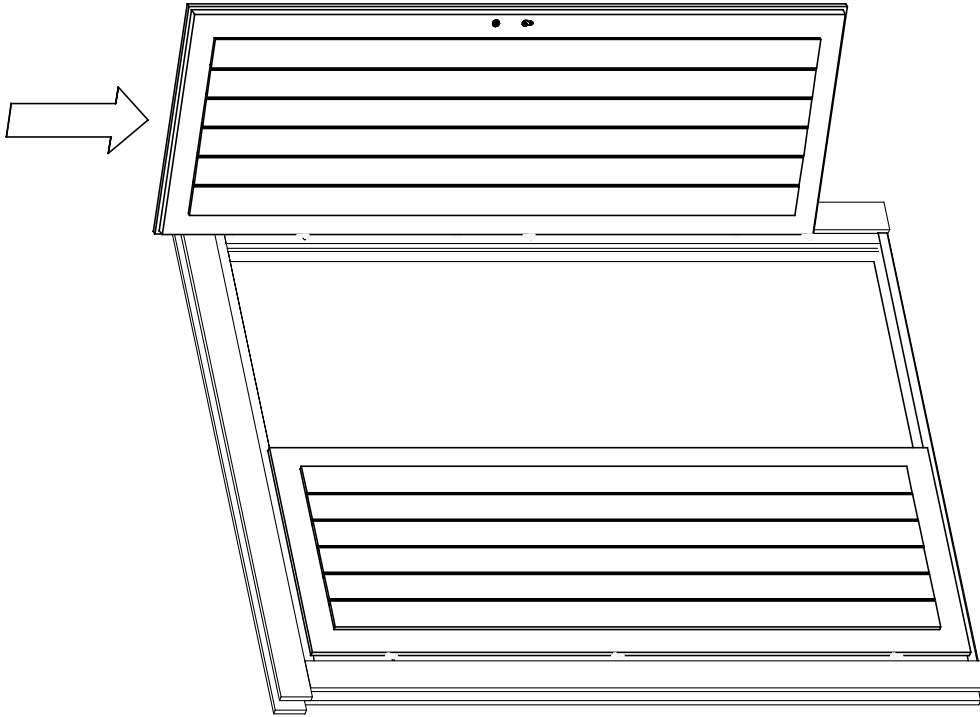

Details

Lisa 44-C

