

A (4x) Beilag-scheibe M8

B (2x) Mutter M8

H (2x) Spax 3x16 mm

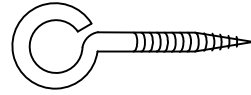

J (1x) Ringschraube Holzgewinde 6x60 mm

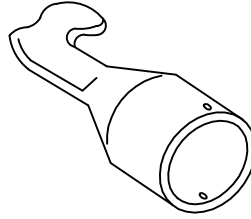

M (1x) Zugstockhaken Ø30x87 mm

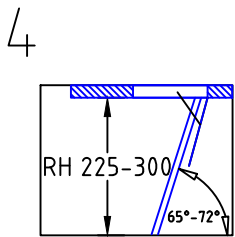
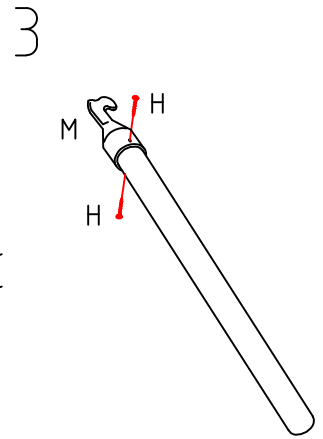
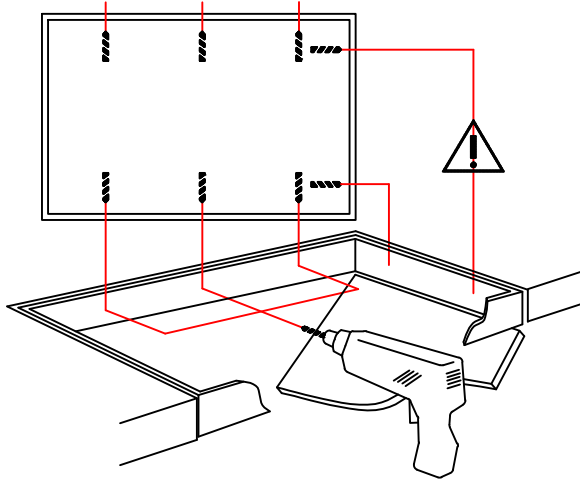
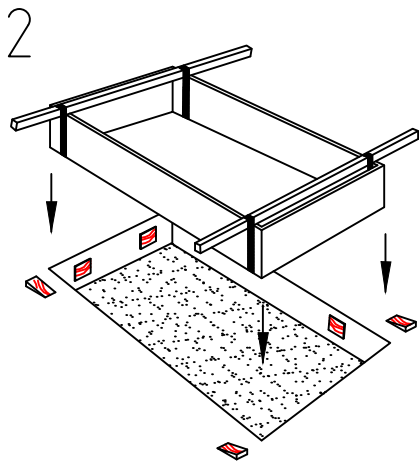
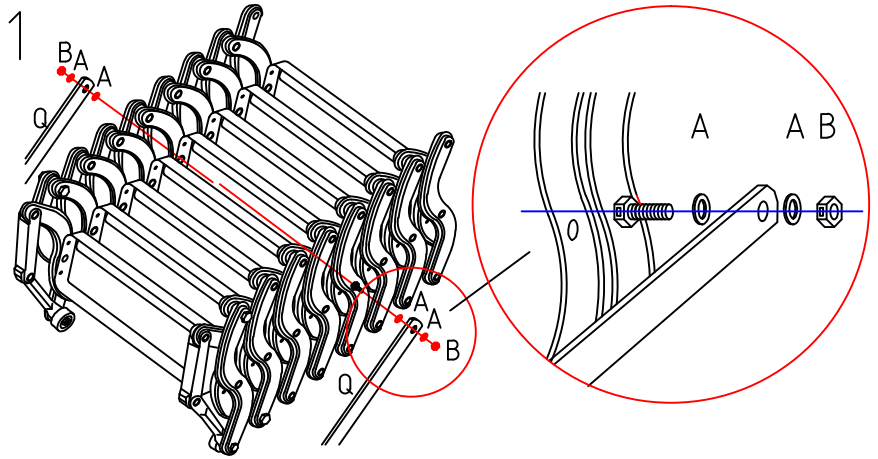

225-250

250-275

275-300

