

Caroline 28

Wandaußenmaß: 240 x 200 cm

Bohlenstärke: 28 mm



Kontrolliert durch:

Achtung: Alle angegebenen Maße sind ca.-Maße!

3D-Darstellung Caroline 28

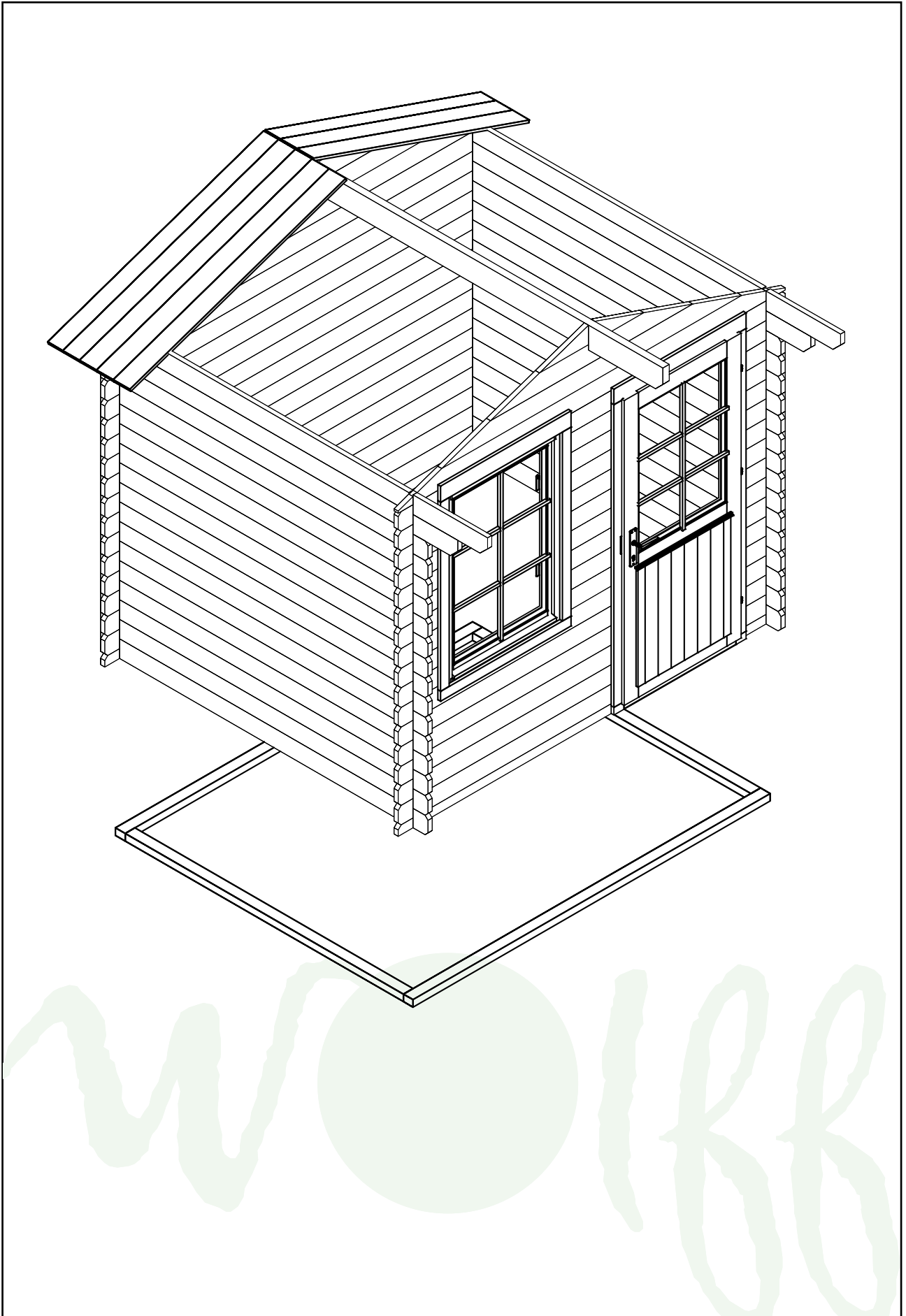

Grundriss Caroline 28

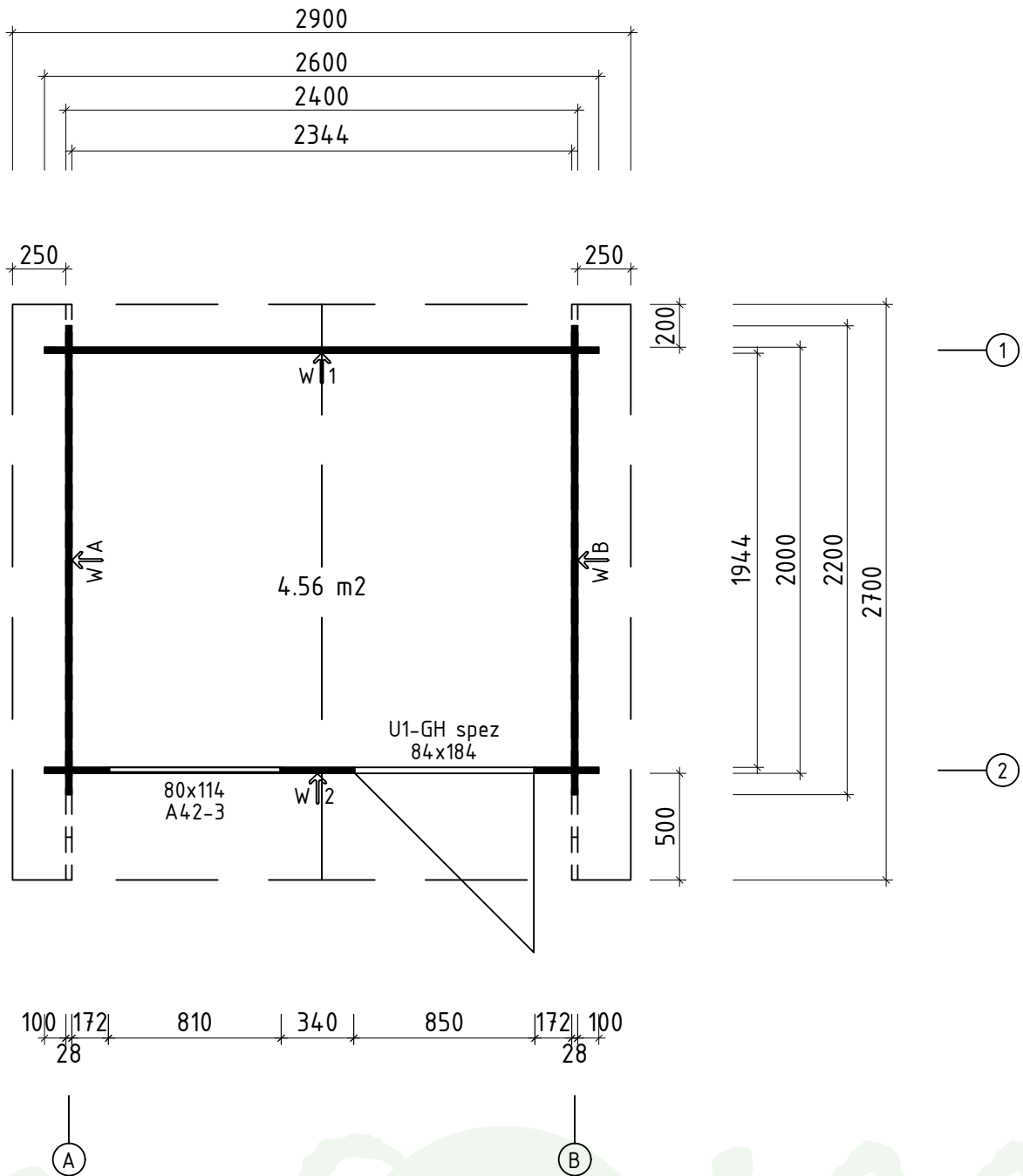

*Fenster und Türen sind mit Sprossen

Lagerholzplan und Fundamentplan Caroline 28

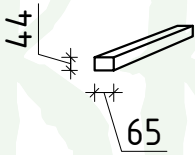
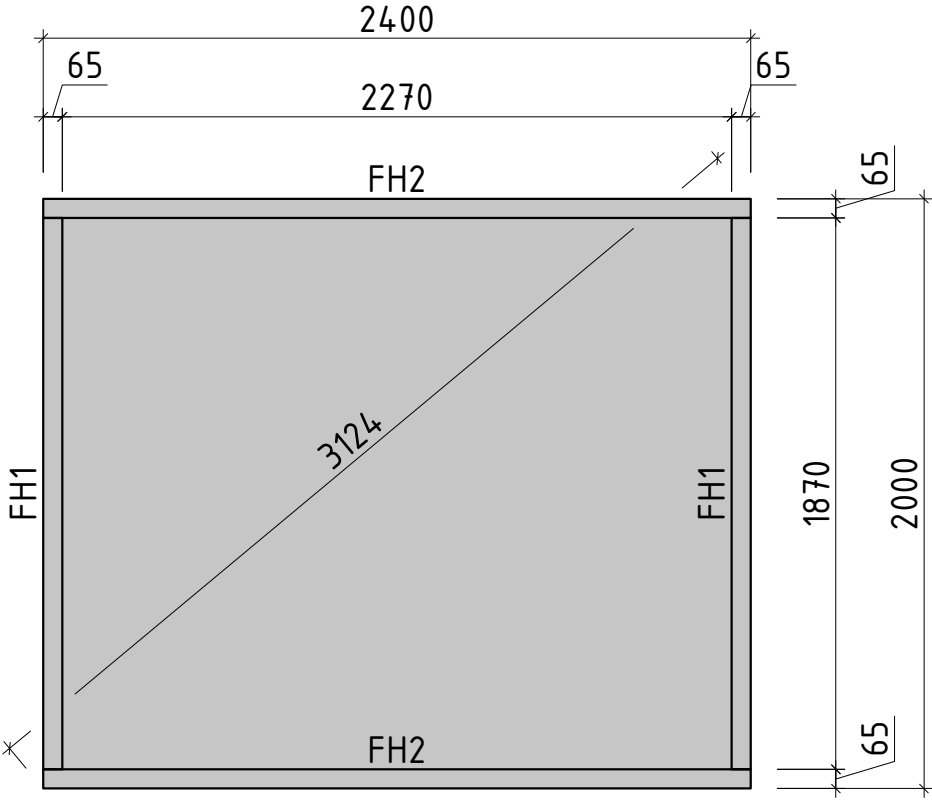







Teileliste 1

Caroline 28

Pos		Stck	Profil (mm)	Länge (mm)
001		1	28x114	2700
002		1	28x114	2700
003		1	28x57	2600
004		16	28x114	2600
005		2	28x114	2600
006		2	28x114	2400
007		30	28x114	2200
008		2	28x114	2015
009		1	28x57	1450
010		1	28x114	1450
011		5	28x114	1450
012		2	28x114	1358
013		10	28x114	340
014		2	28x114	329
015		2	28x114	329
016		26	28x114	300
017		1	28x57	300
FH2	FUNDAMENTHÖLZER (imprägniert) 	2	65x44	2400
FH1	FUNDAMENTHÖLZER (imprägniert) 	2	65x44	1870
PF1	PFETTEN 	1	44x145	2700
	DACHBRETTER 	48+1	113x16	1535
G02-1	GIEBELBRETTER 18x120 	4	18x120	1615
G06-1	GIEBELDECKLEISTEN 18x58 	4	18x58	1615
T06-1	TRAUFENLEISTEN 18x40 	2	18x40	2700
T07-1	TRAUFENLEISTEN 18x58 	2	18x58	2700

Teileliste 2

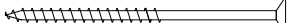
Caroline 28

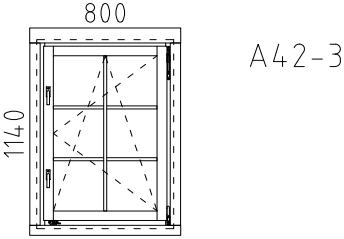
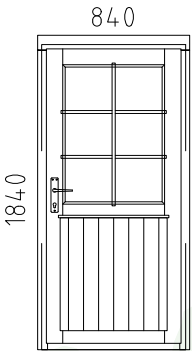
Pos			Stck.	Profil (mm)	Länge (mm)
GS	Giebelsegment		2		
SM-1	Sturmleisten		4	18x40	1825
NG04	NÄGEL 2.5x50	Dachbretter		192	
SR32	SCHRAUBEN 3.0x30	Traufenleiste 40x18		12	
SR37	SCHRAUBEN 3.5x45	Giebelleisten, Giebelbretter Traufenleiste 58x18, Giebelsegment		48	
SR57	SCHRAUBEN 5.0x100	Fundamenthölzer		16	
SH	Schlaghölzer		3		
SS03	Schloßschrauben M8x60 Mutter M8 U-Scheibe Ø25 - Befestigung für Sturmleisten		12		
	FENSTER 800x1140		1		
	TÜR 840x1840		1		
	✓ - bitte selber anpassen (falls nötig)!				

Wandplan 2 Caroline 28

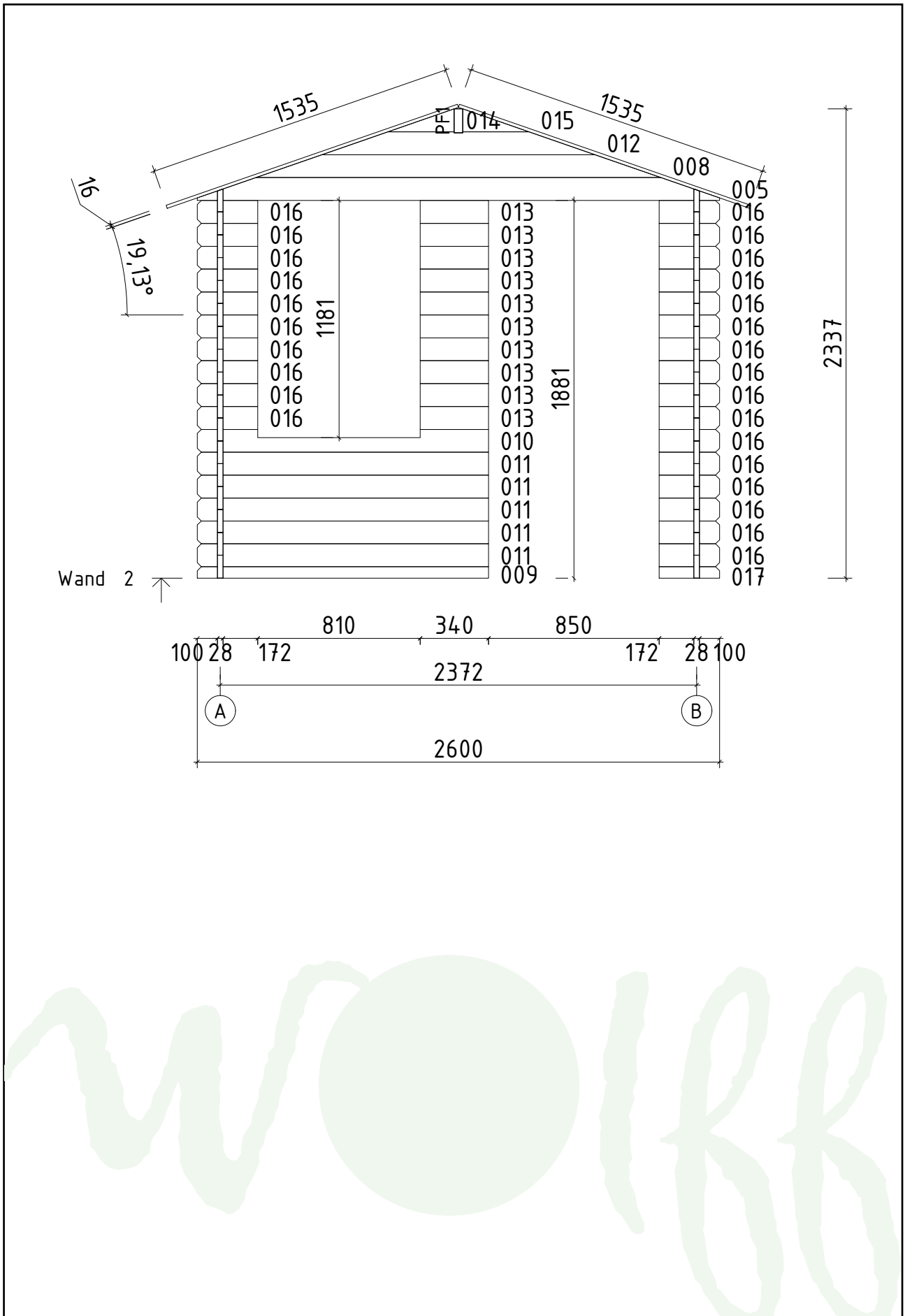

Wandplan A

Caroline 28

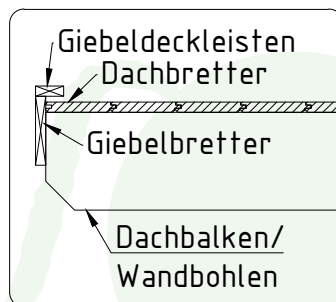
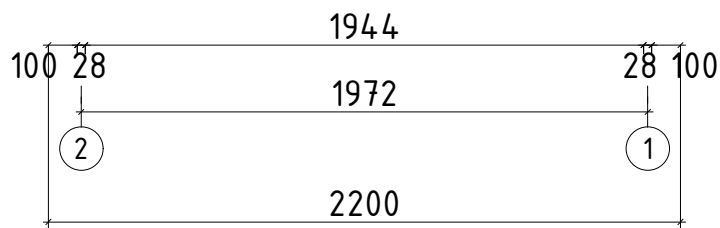
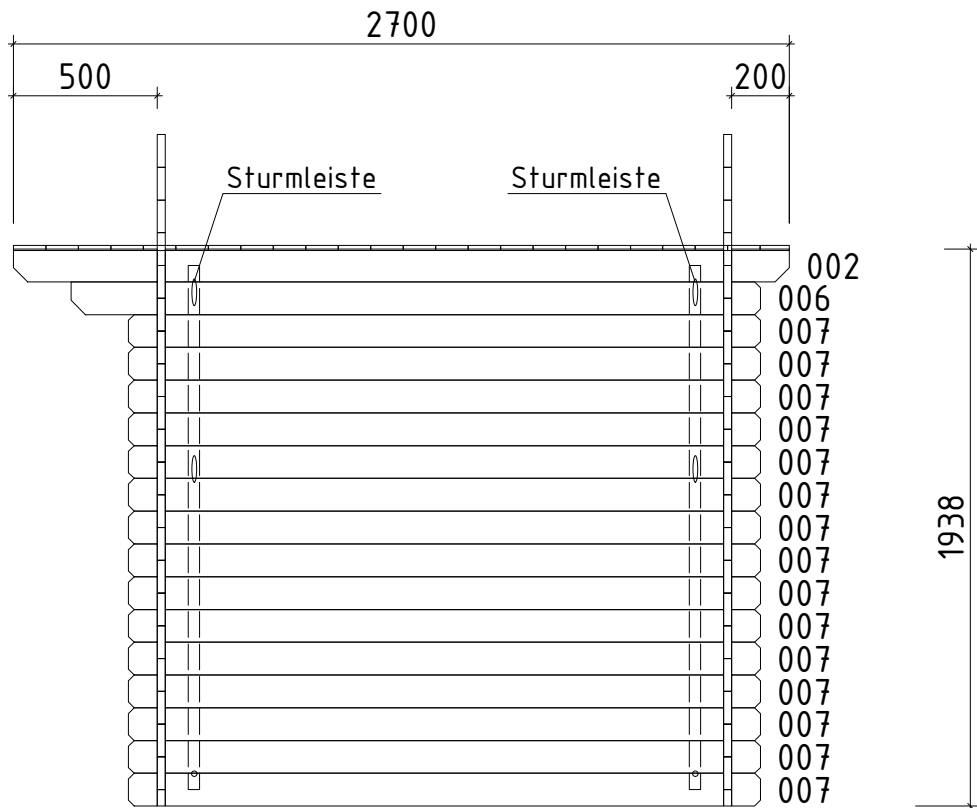

Wandplan B

Caroline 28

