

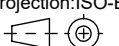

material number: 3006043

local article number: 385412

 ACO GmbH Am Ahlmannkai 24782 Büdelsdorf www.aco.com	drawing-no.: 1254358	index: 002	documenttype: marketing drw.
	created by:	reviewed by:	projection: ISO-E 
title: Concrete light shaft Concrete light shaft SLW 1800x1500x500, with ground - assembly Beton Lichtschacht LKW 1800x1500x500, mit Boden - Baugruppe			serial-released
<small>The reproduction, distribution and utilization of this document as well as the communication of its contents to others without express authorization is prohibited. Offenders will be held liable for the payment of damages. All rights reserved in the event of the grant of a patent, utility model or design. Observe copyright by ISO 16016</small>			release date: 11.10.2023
			sheet: 1/1

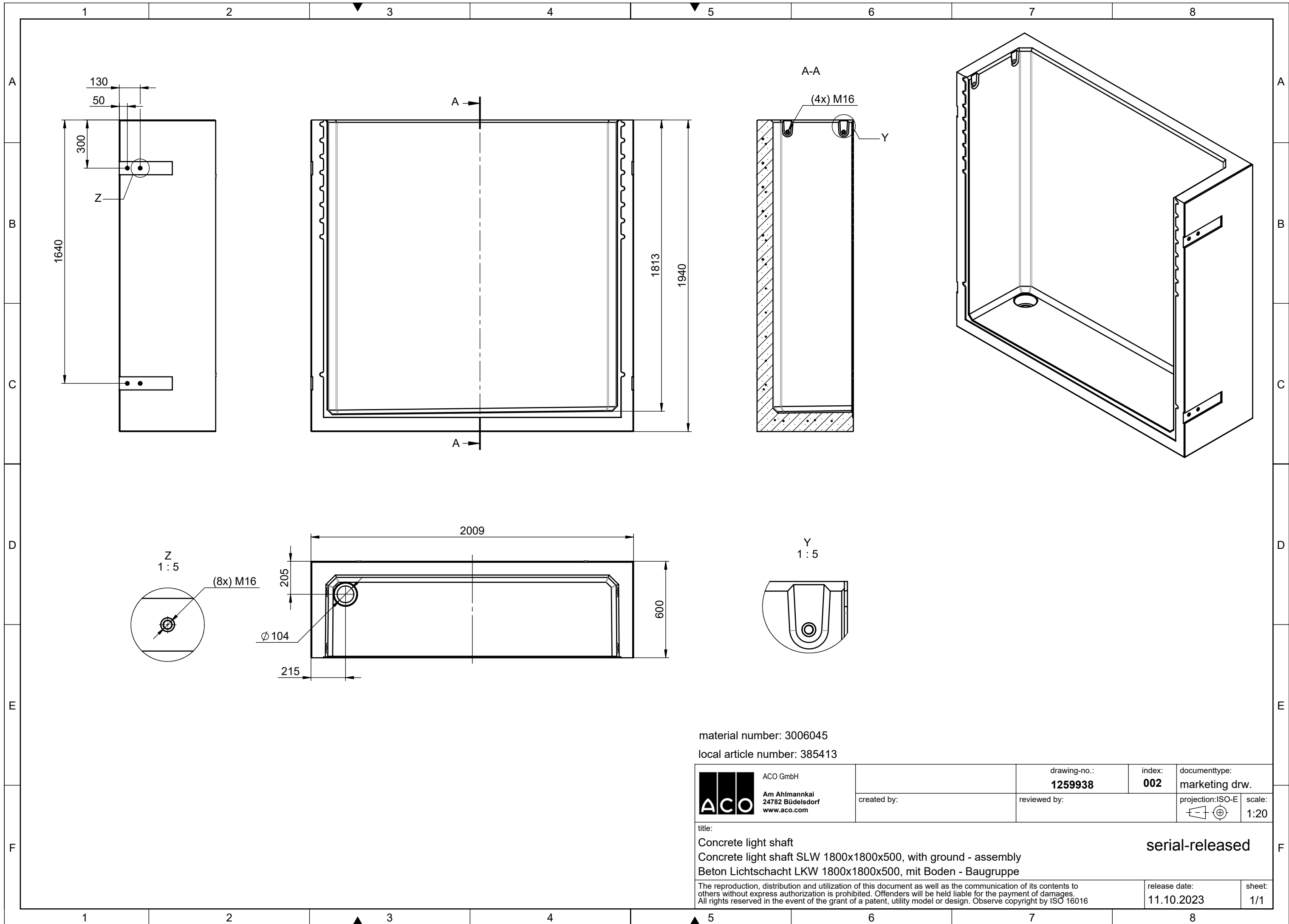

material number: 3006045
 local article number: 385413

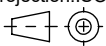
 ACO GmbH Am Ahlmannkai 24782 Büdelsdorf www.aco.com	drawing-no.: 1259938	index: 002	documenttype: marketing drw.	
	created by:	reviewed by:	projection: ISO-E 	scale: 1:20
title: Concrete light shaft Concrete light shaft SLW 1800x1800x500, with ground - assembly Beton Lichtschacht LKW 1800x1800x500, mit Boden - Baugruppe			serial-released	
<small>The reproduction, distribution and utilization of this document as well as the communication of its contents to others without express authorization is prohibited. Offenders will be held liable for the payment of damages. All rights reserved in the event of the grant of a patent, utility model or design. Observe copyright by ISO 16016</small>			release date: 11.10.2023	sheet: 1/1

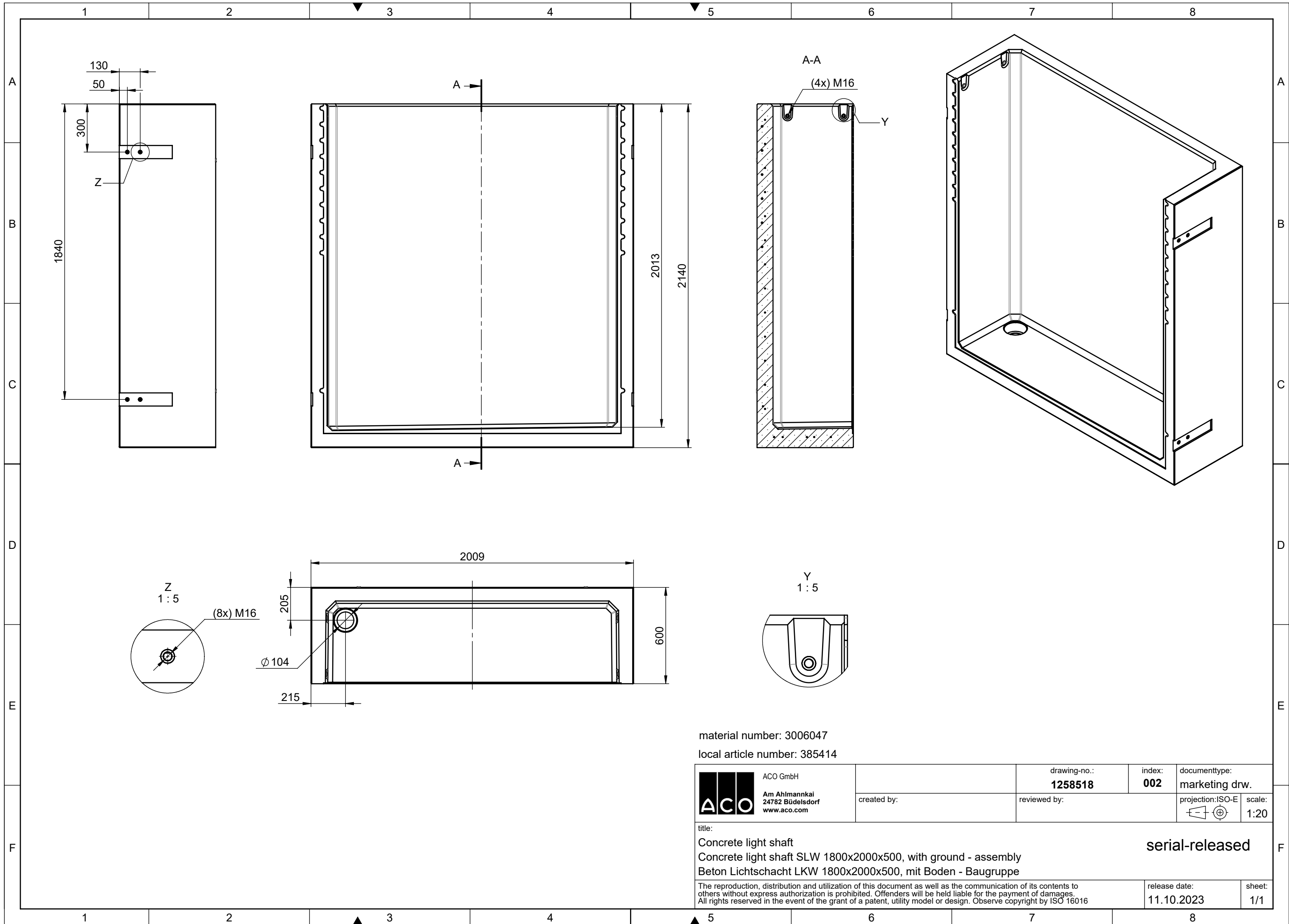

material number: 3006047
 local article number: 385414

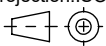
 ACO GmbH Am Ahlmannkai 24782 Büdelsdorf www.aco.com	drawing-no.: 1258518	index: 002	documenttype: marketing drw.	
	created by:	reviewed by:	projection: ISO-E 	scale: 1:20
title: Concrete light shaft Concrete light shaft SLW 1800x2000x500, with ground - assembly Beton Lichtschacht LKW 1800x2000x500, mit Boden - Baugruppe			serial-released	
<small>The reproduction, distribution and utilization of this document as well as the communication of its contents to others without express authorization is prohibited. Offenders will be held liable for the payment of damages. All rights reserved in the event of the grant of a patent, utility model or design. Observe copyright by ISO 16016</small>			release date: 11.10.2023	sheet: 1/1

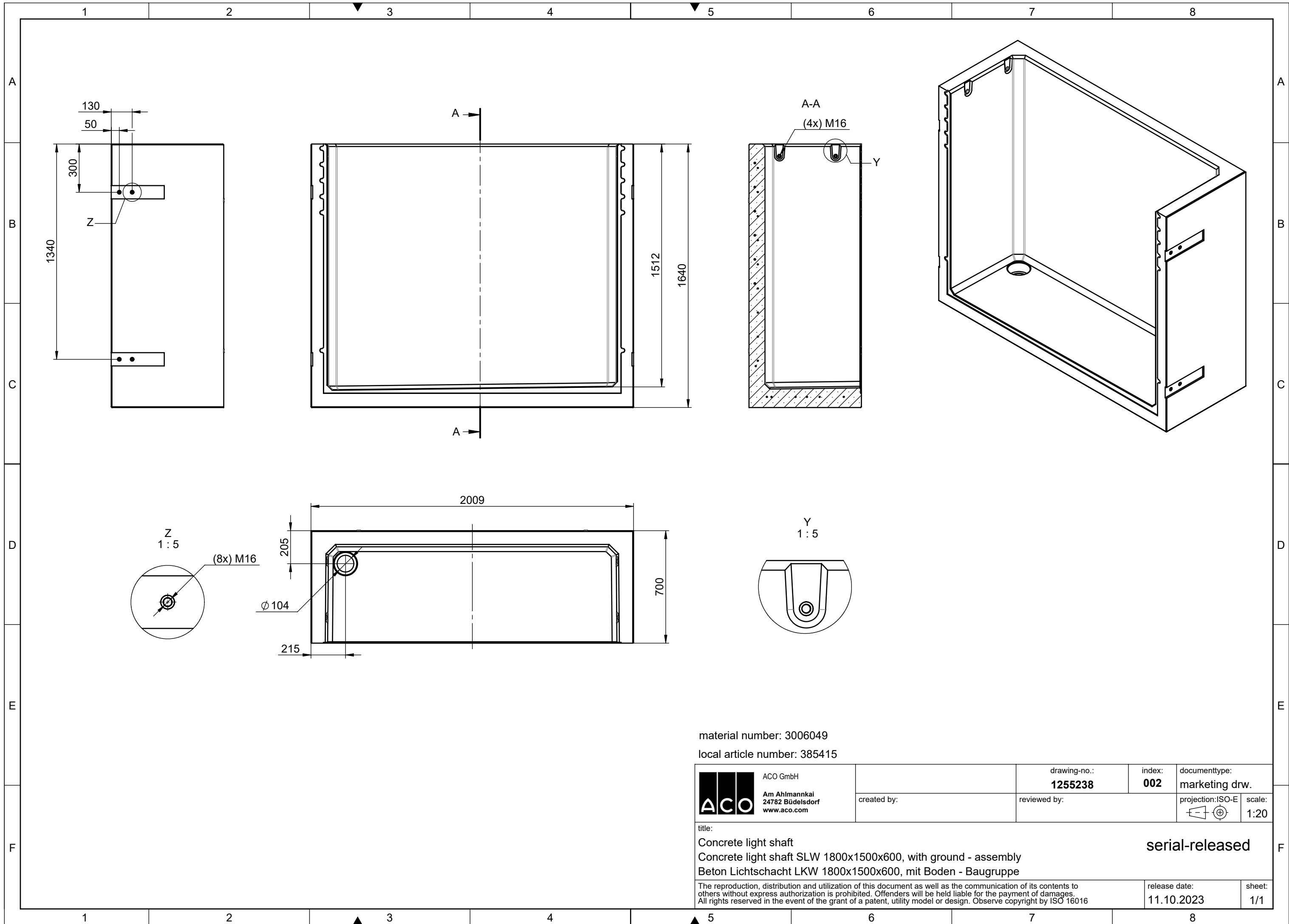

material number: 3006049
 local article number: 385415

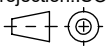
 ACO GmbH Am Ahlmannkai 24782 Büdelsdorf www.aco.com	drawing-no.: 1255238	index: 002	documenttype: marketing drw.
	created by:	reviewed by:	projection: ISO-E 
title: Concrete light shaft Concrete light shaft SLW 1800x1500x600, with ground - assembly Beton Lichtschacht LKW 1800x1500x600, mit Boden - Baugruppe			serial-released release date: 11.10.2023
<small>The reproduction, distribution and utilization of this document as well as the communication of its contents to others without express authorization is prohibited. Offenders will be held liable for the payment of damages. All rights reserved in the event of the grant of a patent, utility model or design. Observe copyright by ISO 16016</small>			sheet: 1/1

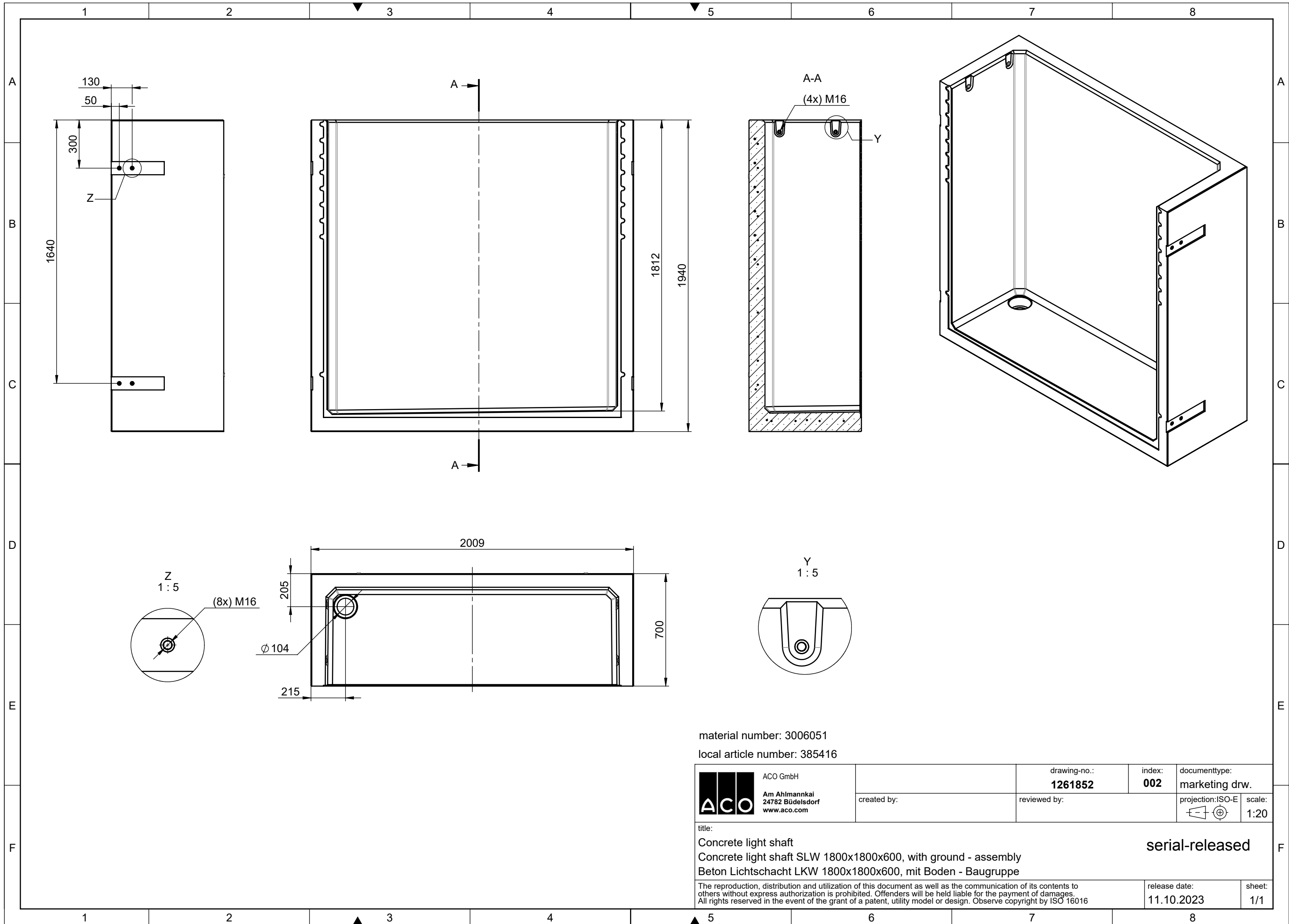

material number: 3006051
 local article number: 385416

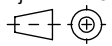
 ACO GmbH Am Ahlmannkai 24782 Büdelsdorf www.aco.com	drawing-no.: 1261852	index: 002	documenttype: marketing drw.	
	created by:	reviewed by:	projection: ISO-E 	scale: 1:20
title: Concrete light shaft Concrete light shaft SLW 1800x1800x600, with ground - assembly Beton Lichtschacht LKW 1800x1800x600, mit Boden - Baugruppe			serial-released	
<small>The reproduction, distribution and utilization of this document as well as the communication of its contents to others without express authorization is prohibited. Offenders will be held liable for the payment of damages. All rights reserved in the event of the grant of a patent, utility model or design. Observe copyright by ISO 16016</small>			release date: 11.10.2023	sheet: 1/1

S:\projekte\2023\1261852\ACO_Verschnitt.dwg

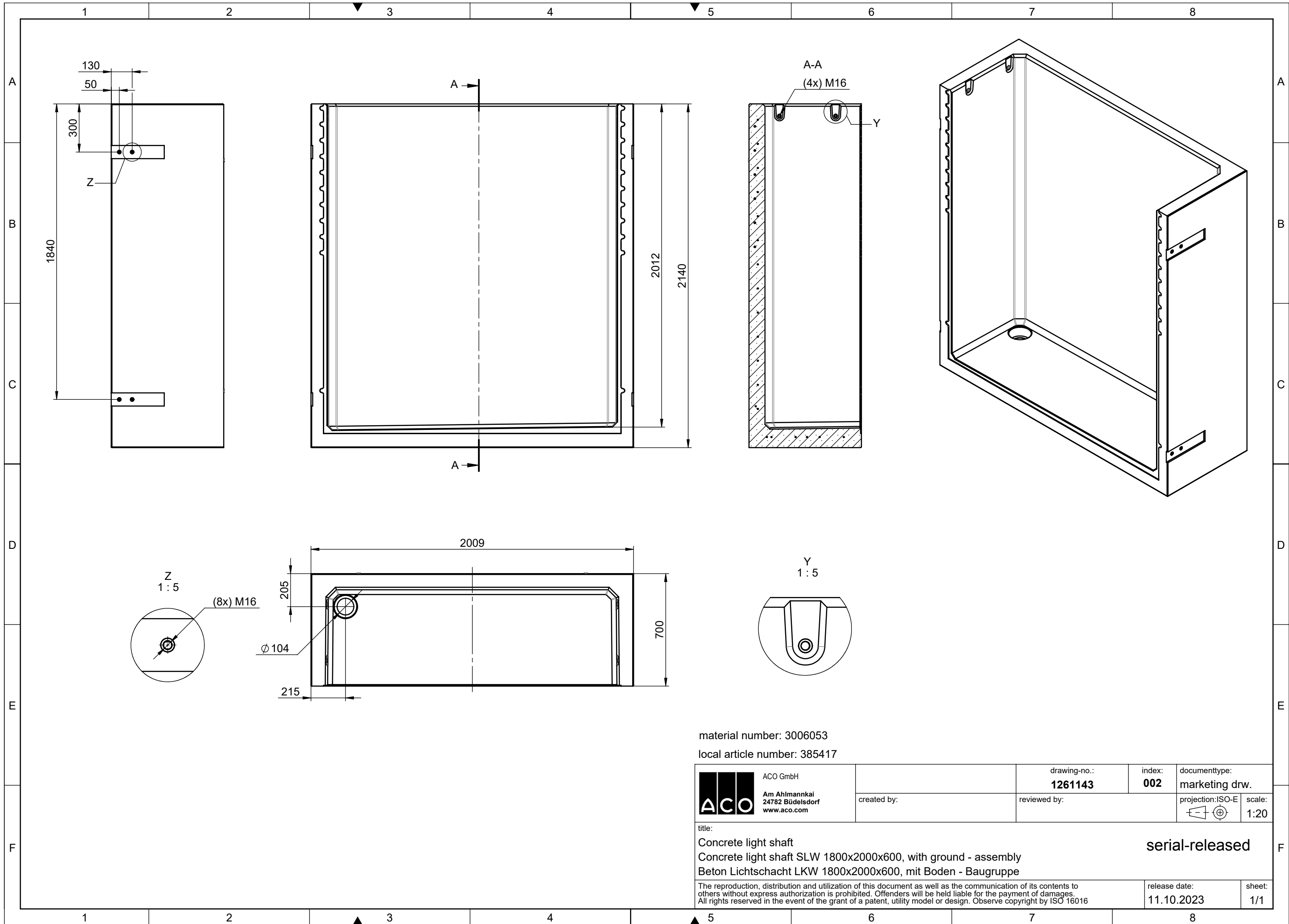

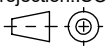

material number: 3006053
 local article number: 385417

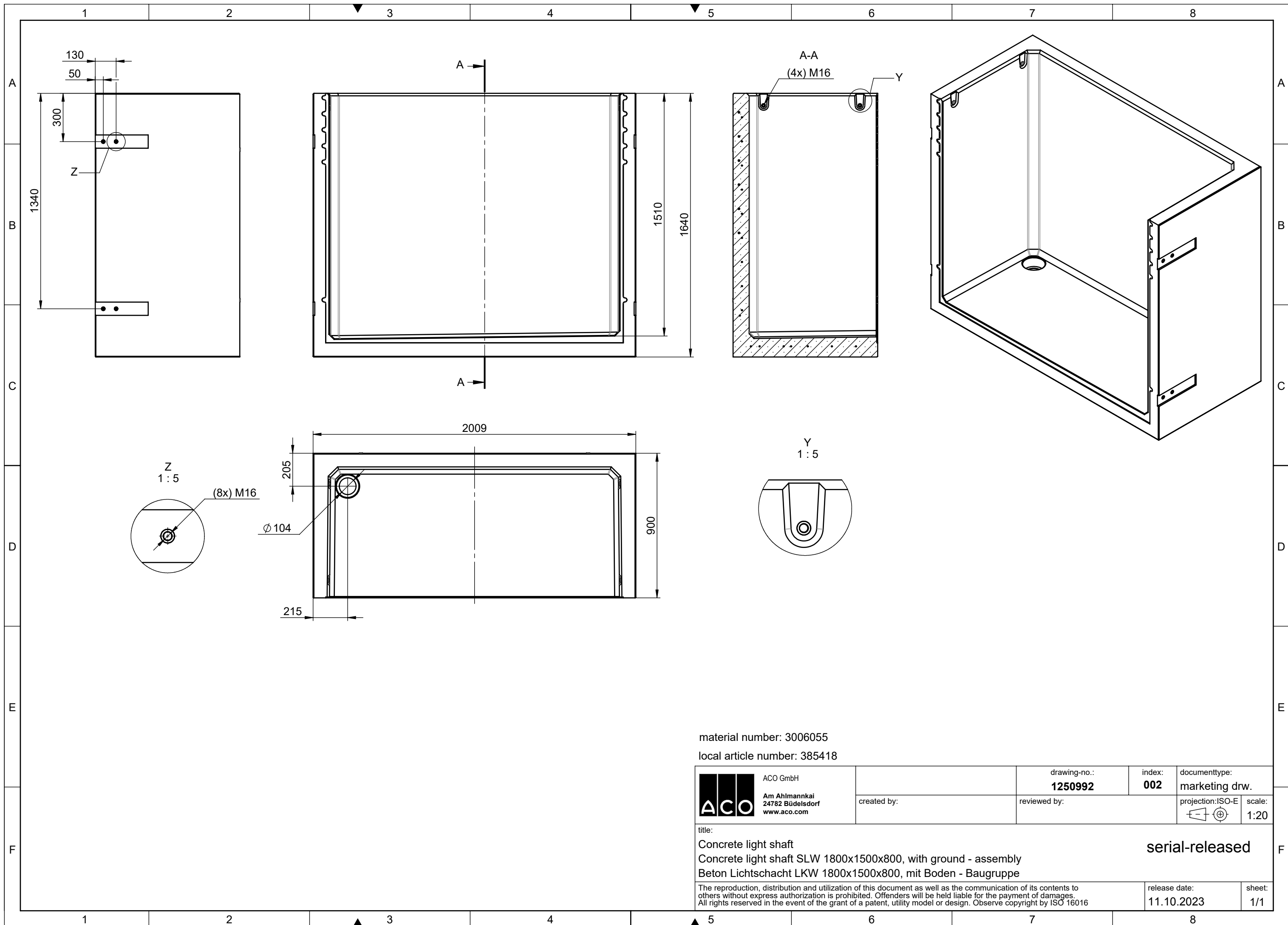
 ACO GmbH Am Ahlmannkai 24782 Büdelsdorf www.aco.com	drawing-no.: 1261143	index: 002	documenttype: marketing drw.	
	created by:	reviewed by:	projection: ISO-E 	scale: 1:20
title: Concrete light shaft Concrete light shaft SLW 1800x2000x600, with ground - assembly Beton Lichtschacht LKW 1800x2000x600, mit Boden - Baugruppe			serial-released	
<small>The reproduction, distribution and utilization of this document as well as the communication of its contents to others without express authorization is prohibited. Offenders will be held liable for the payment of damages. All rights reserved in the event of the grant of a patent, utility model or design. Observe copyright by ISO 16016</small>			release date: 11.10.2023	sheet: 1/1



material number: 3006055

local article number: 385418

 ACO GmbH Am Ahlmannkai 24782 Büdelsdorf www.aco.com	drawing-no.: 1250992	index: 002	documenttype: marketing drw.
	created by:	reviewed by:	projection: ISO-E  scale: 1:20
title: Concrete light shaft Concrete light shaft SLW 1800x1500x800, with ground - assembly Beton Lichtschacht LKW 1800x1500x800, mit Boden - Baugruppe			serial-released
<small>The reproduction, distribution and utilization of this document as well as the communication of its contents to others without express authorization is prohibited. Offenders will be held liable for the payment of damages. All rights reserved in the event of the grant of a patent, utility model or design. Observe copyright by ISO 16016</small>			release date: 11.10.2023 sheet: 1/1

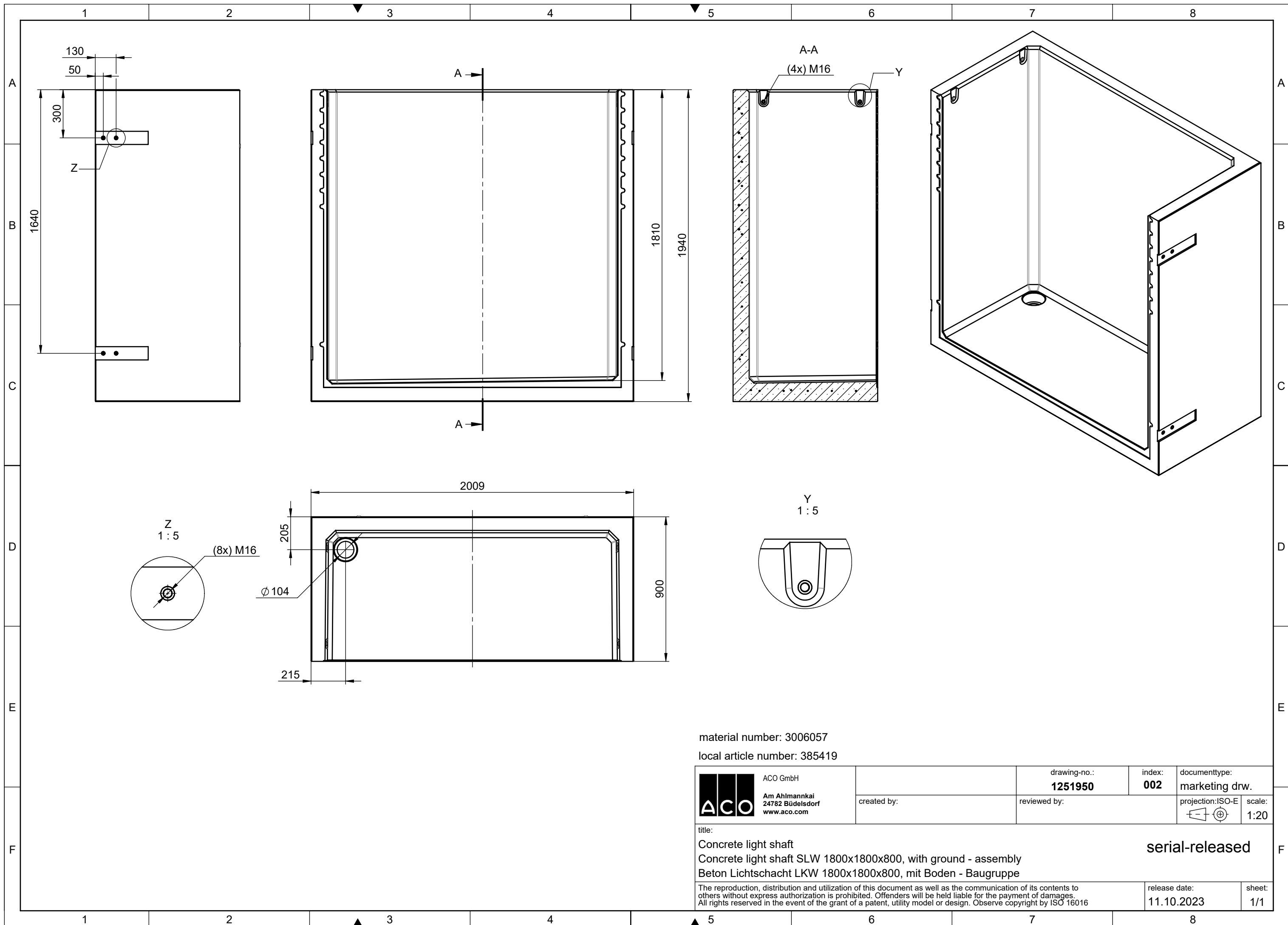

material number: 3006057

local article number: 385419

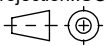
 ACO GmbH Am Ahlmannkai 24782 Büdelsdorf www.aco.com	drawing-no.: 1251950	index: 002	documenttype: marketing drw.
	created by:	reviewed by:	projection: ISO-E  scale: 1:20
title: Concrete light shaft Concrete light shaft SLW 1800x1800x800, with ground - assembly Beton Lichtschacht LKW 1800x1800x800, mit Boden - Baugruppe			serial-released
<small>The reproduction, distribution and utilization of this document as well as the communication of its contents to others without express authorization is prohibited. Offenders will be held liable for the payment of damages. All rights reserved in the event of the grant of a patent, utility model or design. Observe copyright by ISO 16016</small>			release date: 11.10.2023 sheet: 1/1

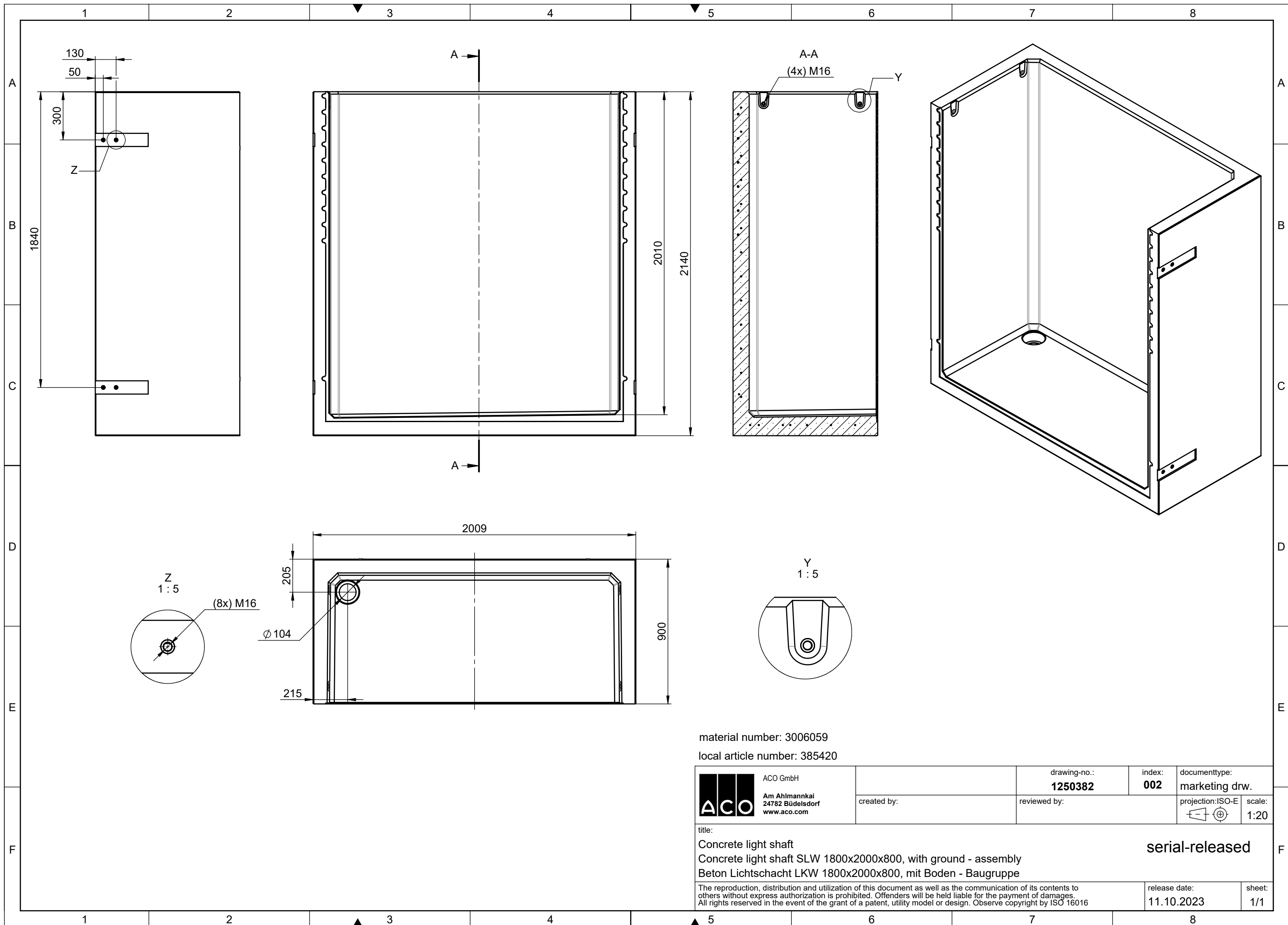

material number: 3006059
 local article number: 385420

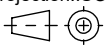
 ACO GmbH Am Ahlmannkai 24782 Büdelsdorf www.aco.com	drawing-no.: 1250382	index: 002	documenttype: marketing drw.	
	created by:	reviewed by:	projection: ISO-E 	scale: 1:20
title: Concrete light shaft Concrete light shaft SLW 1800x2000x800, with ground - assembly Beton Lichtschacht LKW 1800x2000x800, mit Boden - Baugruppe			serial-released	
<small>The reproduction, distribution and utilization of this document as well as the communication of its contents to others without express authorization is prohibited. Offenders will be held liable for the payment of damages. All rights reserved in the event of the grant of a patent, utility model or design. Observe copyright by ISO 16016</small>			release date: 11.10.2023	sheet: 1/1

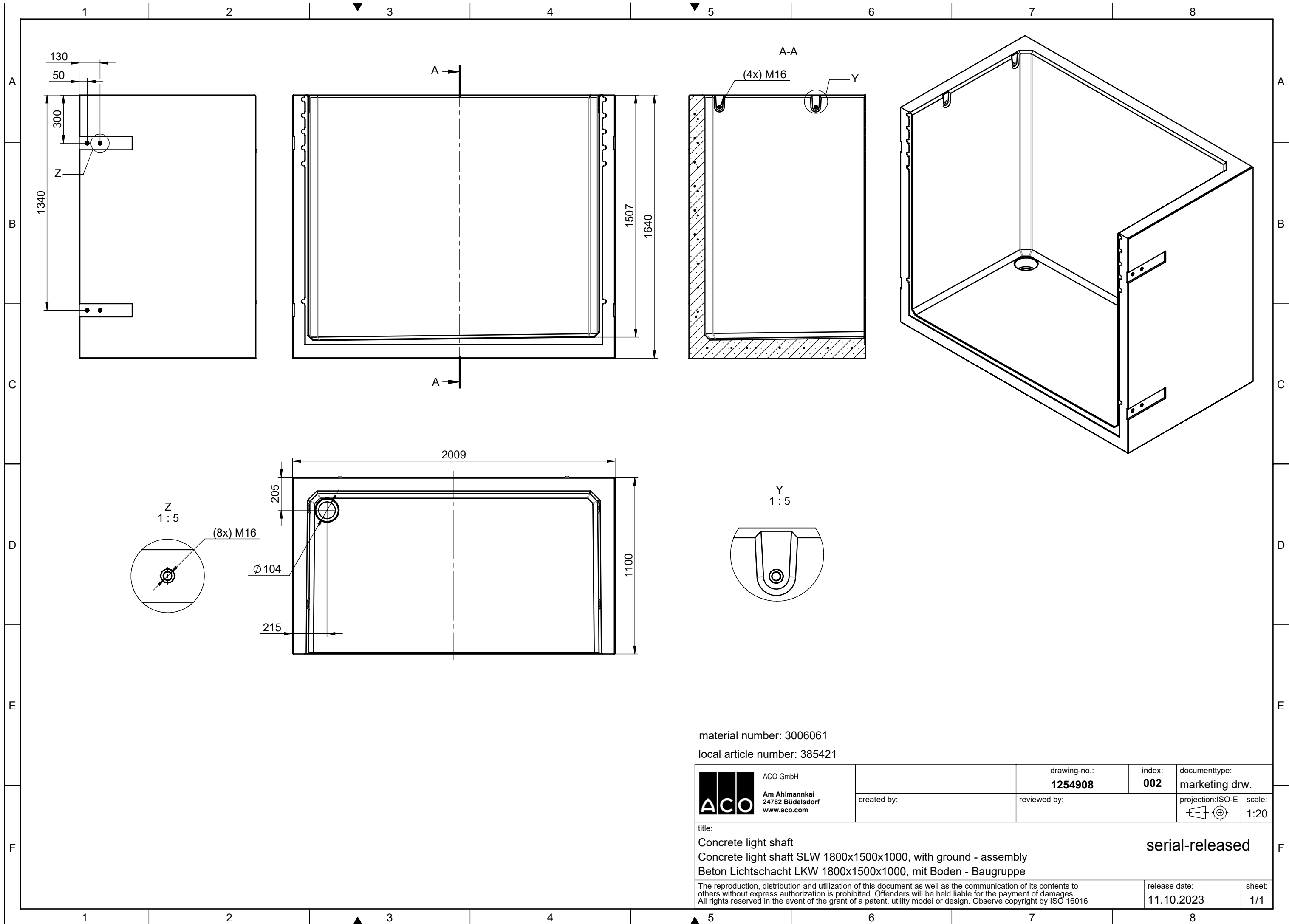

material number: 3006061

local article number: 385421

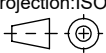
 ACO GmbH Am Ahlmannkai 24782 Büdelsdorf www.aco.com	drawing-no.: 1254908	index: 002	documenttype: marketing drw.	
	created by:	reviewed by:	projection: ISO-E 	scale: 1:20
title: Concrete light shaft Concrete light shaft SLW 1800x1500x1000, with ground - assembly Beton Lichtschacht LKW 1800x1500x1000, mit Boden - Baugruppe			serial-released	
<small>The reproduction, distribution and utilization of this document as well as the communication of its contents to others without express authorization is prohibited. Offenders will be held liable for the payment of damages. All rights reserved in the event of the grant of a patent, utility model or design. Observe copyright by ISO 16016</small>			release date: 11.10.2023	sheet: 1/1

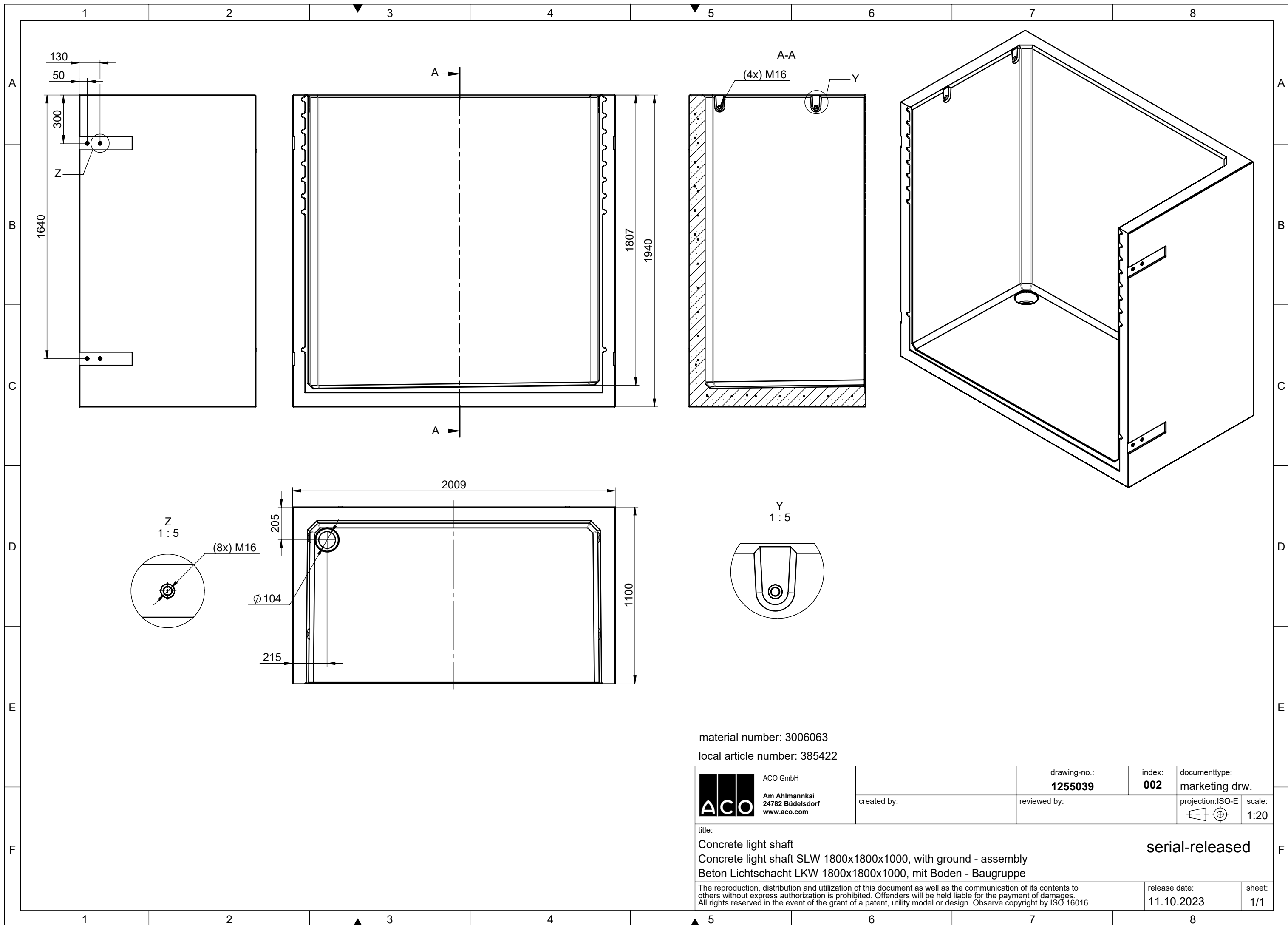

material number: 3006063

local article number: 385422

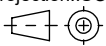
 ACO GmbH Am Ahlmannkai 24782 Büdelsdorf www.aco.com	drawing-no.: 1255039	index: 002	documenttype: marketing drw.
	created by:	reviewed by:	projection: ISO-E  scale: 1:20
title: Concrete light shaft Concrete light shaft SLW 1800x1800x1000, with ground - assembly Beton Lichtschacht LKW 1800x1800x1000, mit Boden - Baugruppe			serial-released
<small>The reproduction, distribution and utilization of this document as well as the communication of its contents to others without express authorization is prohibited. Offenders will be held liable for the payment of damages. All rights reserved in the event of the grant of a patent, utility model or design. Observe copyright by ISO 16016</small>			release date: 11.10.2023 sheet: 1/1

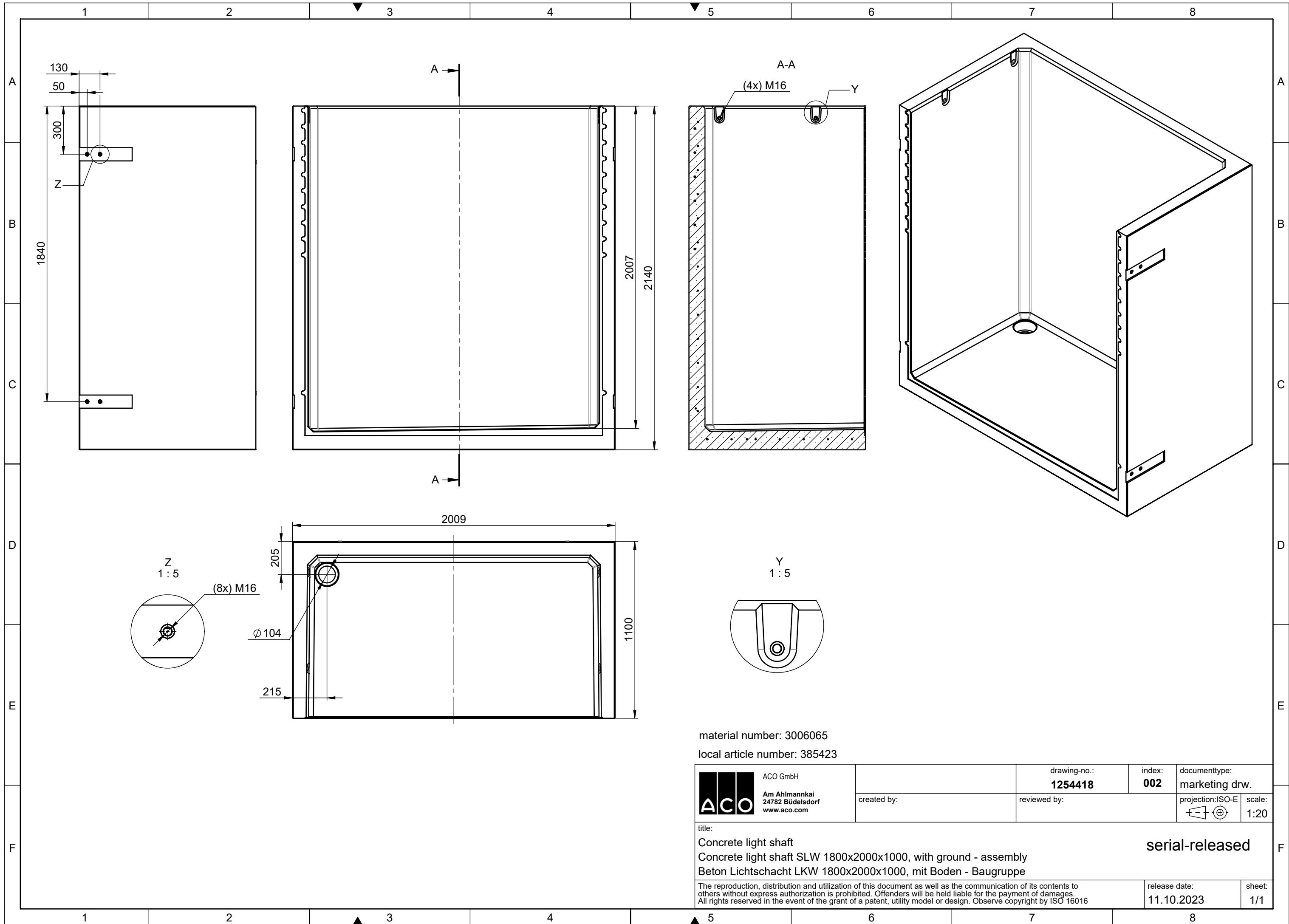

material number: 3006065
 local article number: 385423

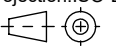
 ACO GmbH Am Ahlmannkai 24782 Büdelsdorf www.aco.com	drawing-no.: 1254418	index: 002	documenttype: marketing drw.
	created by:	reviewed by:	projection: ISO-E 
title: Concrete light shaft Concrete light shaft SLW 1800x2000x1000, with ground - assembly Beton Lichtschacht LKW 1800x2000x1000, mit Boden - Baugruppe			serial-released
<small>The reproduction, distribution and utilization of this document as well as the communication of its contents to others without express authorization is prohibited. Offenders will be held liable for the payment of damages. All rights reserved in the event of the grant of a patent, utility model or design. Observe copyright by ISO 16016</small>			release date: 11.10.2023
			sheet: 1/1

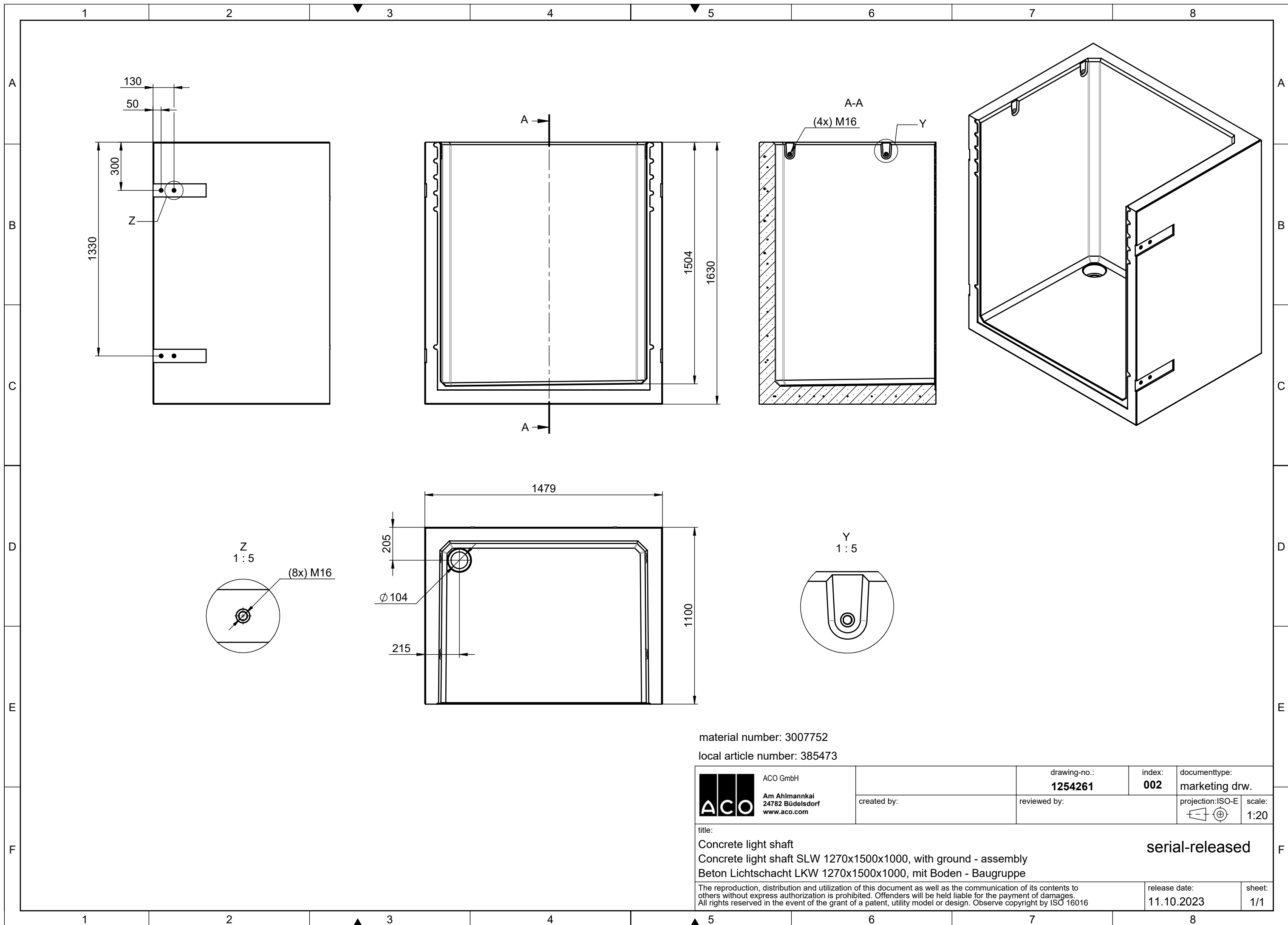

material number: 3007752

local article number: 385473

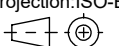
 ACO GmbH Am Ahlmannkai 24782 Büdelsdorf www.aco.com	drawing-no.: 1254261	index: 002	documenttype: marketing drw.
	created by:	reviewed by:	projection: ISO-E 
title: Concrete light shaft Concrete light shaft SLW 1270x1500x1000, with ground - assembly Beton Lichtschacht LKW 1270x1500x1000, mit Boden - Baugruppe			serial-released
<small>The reproduction, distribution and utilization of this document as well as the communication of its contents to others without express authorization is prohibited. Offenders will be held liable for the payment of damages. All rights reserved in the event of the grant of a patent, utility model or design. Observe copyright by ISO 16016</small>			release date: 11.10.2023
			sheet: 1/1

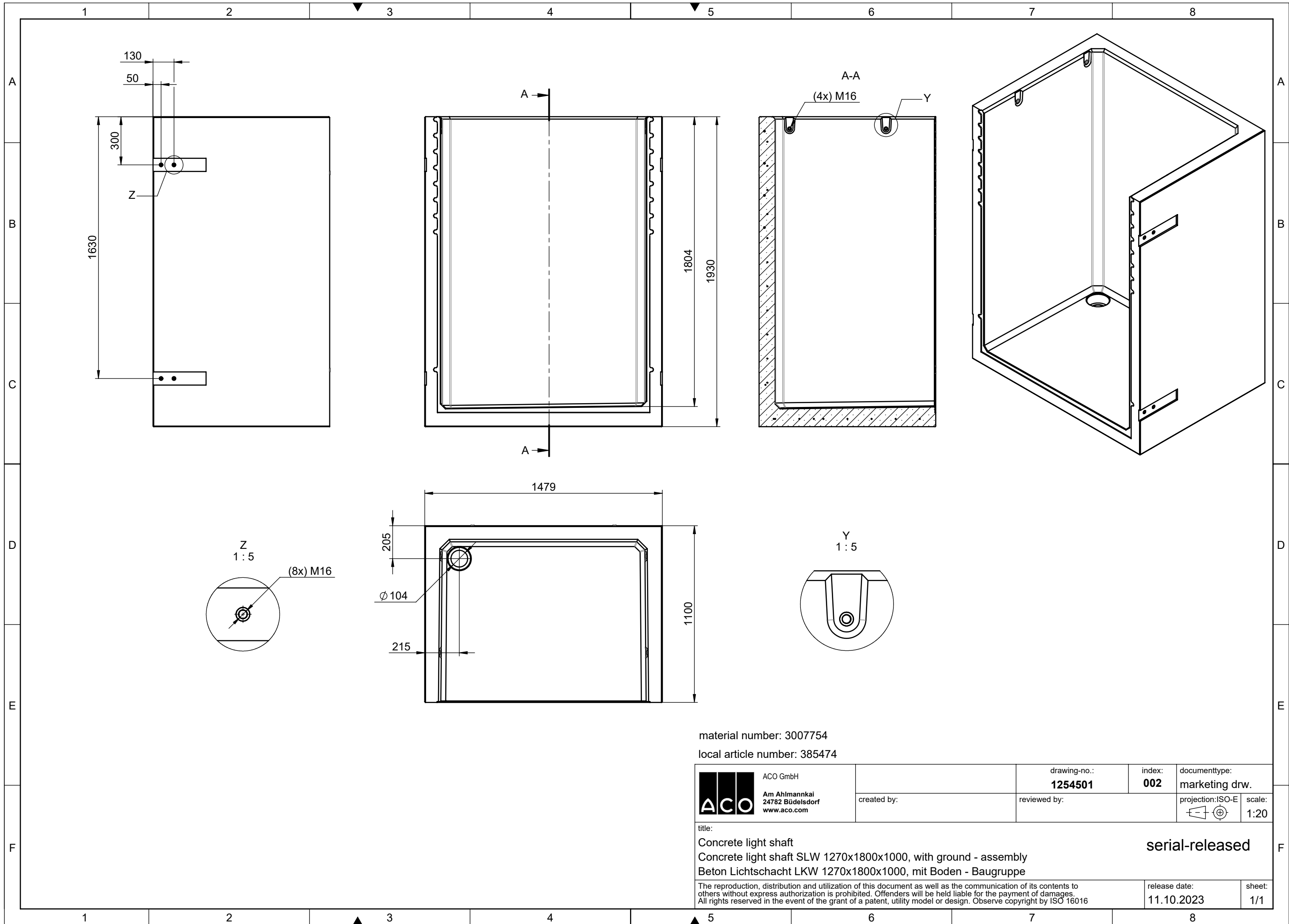

material number: 3007754

local article number: 385474

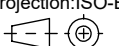
 ACO GmbH Am Ahlmannkai 24782 Büdelsdorf www.aco.com	drawing-no.: 1254501	index: 002	documenttype: marketing drw.	
	created by:	reviewed by:	projection: ISO-E 	scale: 1:20
title: Concrete light shaft Concrete light shaft SLW 1270x1800x1000, with ground - assembly Beton Lichtschacht LKW 1270x1800x1000, mit Boden - Baugruppe			serial-released	
<small>The reproduction, distribution and utilization of this document as well as the communication of its contents to others without express authorization is prohibited. Offenders will be held liable for the payment of damages. All rights reserved in the event of the grant of a patent, utility model or design. Observe copyright by ISO 16016</small>			release date: 11.10.2023	sheet: 1/1

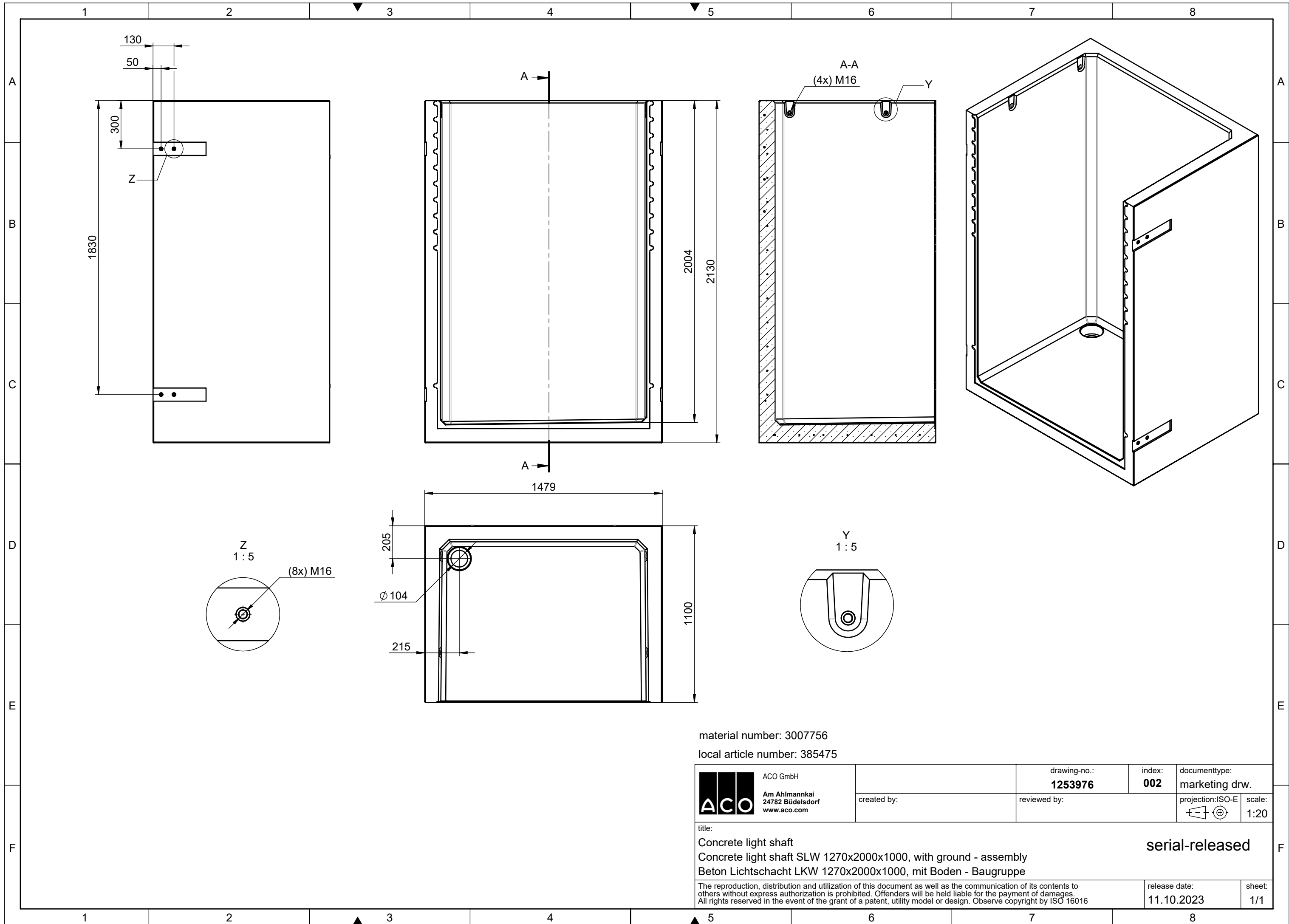

material number: 3007756

local article number: 385475

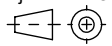
 ACO GmbH Am Ahlmannkai 24782 Büdelsdorf www.aco.com	drawing-no.: 1253976	index: 002	documenttype: marketing drw.	
	created by:	reviewed by:	projection: ISO-E 	scale: 1:20
title: Concrete light shaft Concrete light shaft SLW 1270x2000x1000, with ground - assembly Beton Lichtschacht LKW 1270x2000x1000, mit Boden - Baugruppe			serial-released	
<small>The reproduction, distribution and utilization of this document as well as the communication of its contents to others without express authorization is prohibited. Offenders will be held liable for the payment of damages. All rights reserved in the event of the grant of a patent, utility model or design. Observe copyright by ISO 16016</small>			release date: 11.10.2023	sheet: 1/1

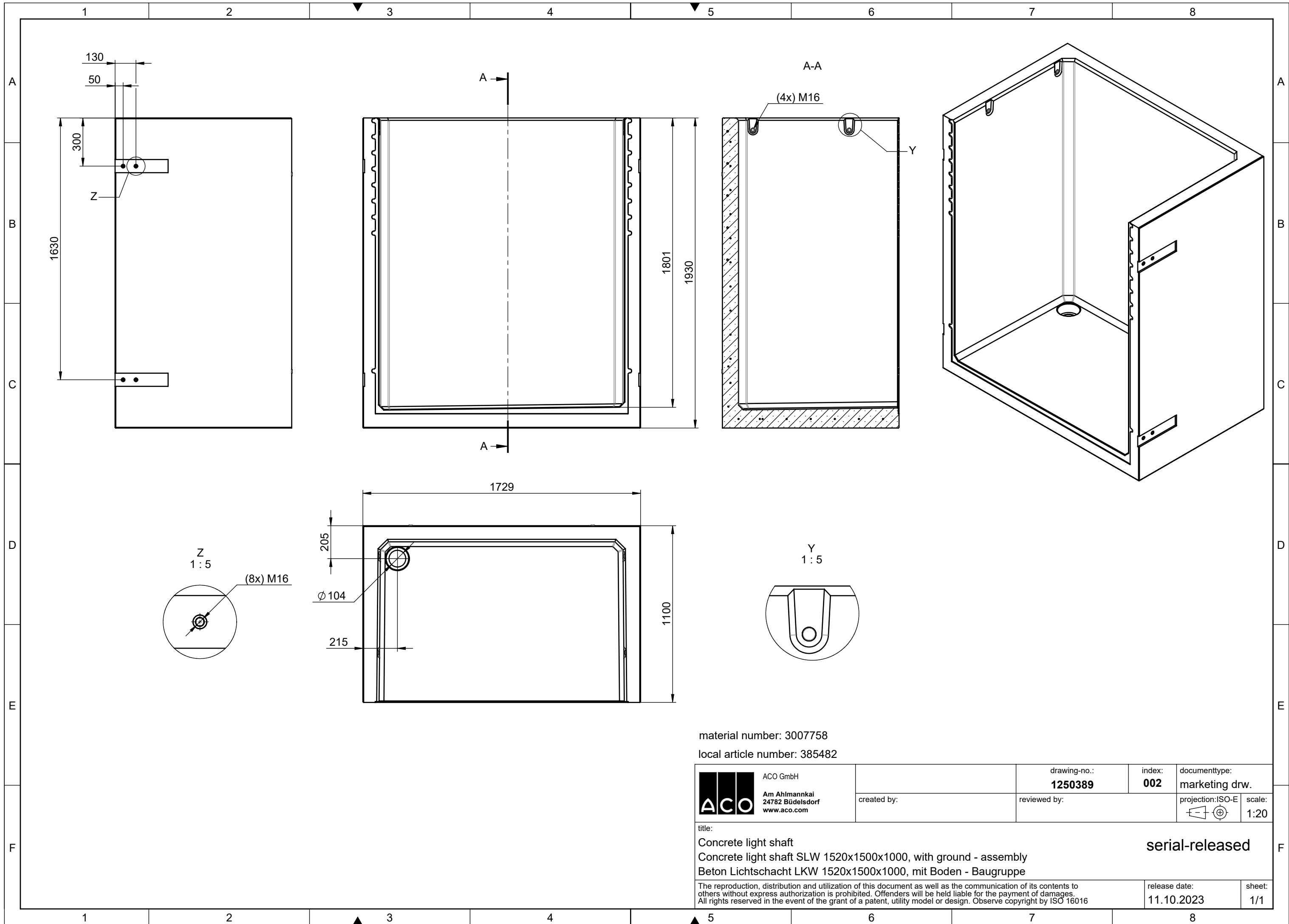

material number: 3007758
 local article number: 385482

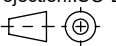
 ACO GmbH Am Ahlmannkai 24782 Büdelsdorf www.aco.com	drawing-no.: 1250389	index: 002	documenttype: marketing drw.	
	created by:	reviewed by:	projection: ISO-E 	scale: 1:20
title: Concrete light shaft Concrete light shaft SLW 1520x1500x1000, with ground - assembly Beton Lichtschacht LKW 1520x1500x1000, mit Boden - Baugruppe			serial-released	
<small>The reproduction, distribution and utilization of this document as well as the communication of its contents to others without express authorization is prohibited. Offenders will be held liable for the payment of damages. All rights reserved in the event of the grant of a patent, utility model or design. Observe copyright by ISO 16016</small>			release date: 11.10.2023	sheet: 1/1

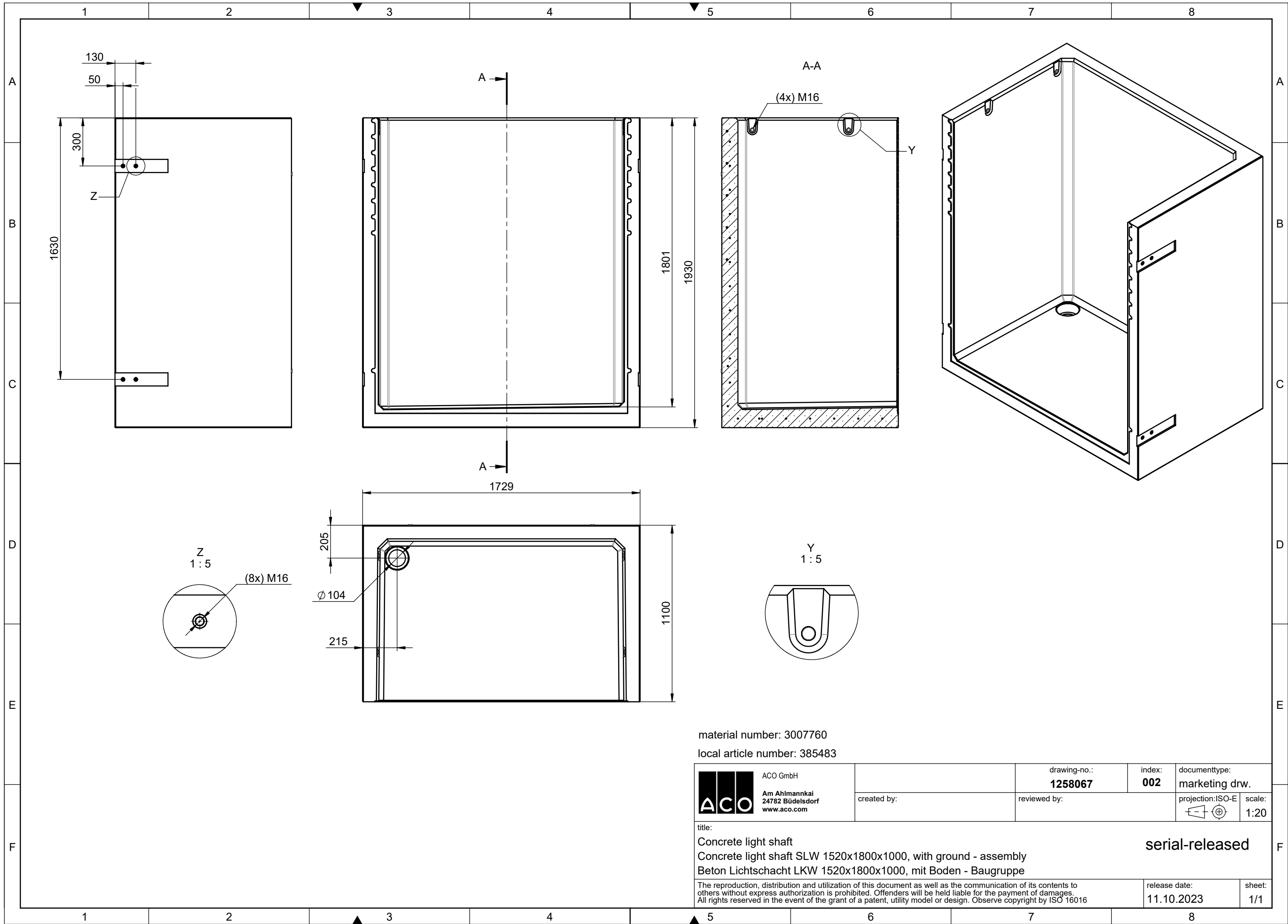

material number: 3007760
 local article number: 385483

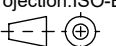
 ACO GmbH Am Ahlmannkai 24782 Büdelsdorf www.aco.com	drawing-no.: 1258067	index: 002	documenttype: marketing drw.	
	created by:	reviewed by:	projection: ISO-E 	scale: 1:20
title: Concrete light shaft Concrete light shaft SLW 1520x1800x1000, with ground - assembly Beton Lichtschacht LKW 1520x1800x1000, mit Boden - Baugruppe			serial-released	
<small>The reproduction, distribution and utilization of this document as well as the communication of its contents to others without express authorization is prohibited. Offenders will be held liable for the payment of damages. All rights reserved in the event of the grant of a patent, utility model or design. Observe copyright by ISO 16016</small>			release date: 11.10.2023	sheet: 1/1

S:\projekte\2023\1258067\ACO - Version 1.6

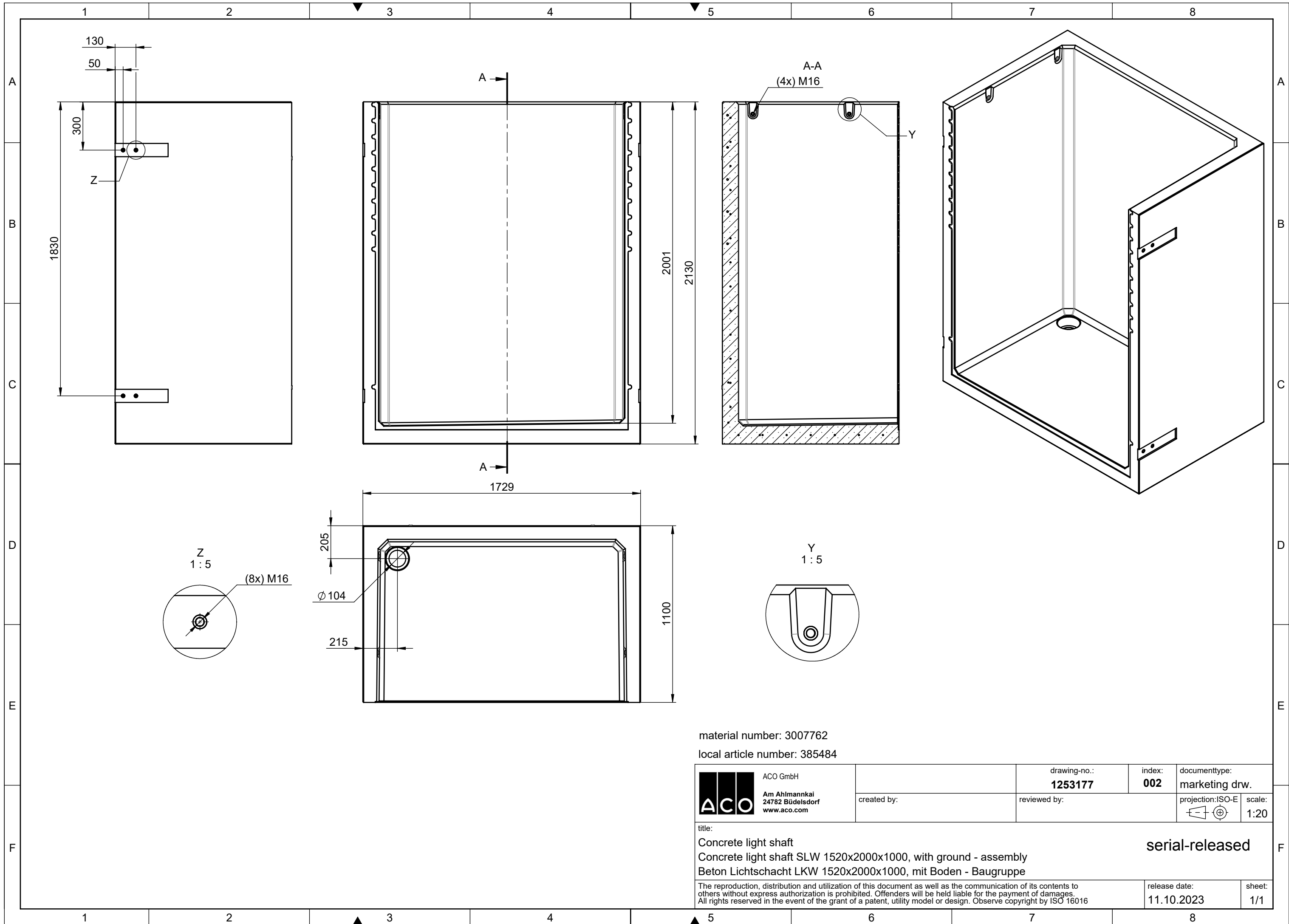

material number: 3007762
 local article number: 385484

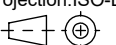
 ACO GmbH Am Ahlmannkai 24782 Büdelsdorf www.aco.com	drawing-no.: 1253177	index: 002	documenttype: marketing drw.	
	created by:	reviewed by:	projection: ISO-E 	scale: 1:20
title: Concrete light shaft Concrete light shaft SLW 1520x2000x1000, with ground - assembly Beton Lichtschacht LKW 1520x2000x1000, mit Boden - Baugruppe			serial-released	
<small>The reproduction, distribution and utilization of this document as well as the communication of its contents to others without express authorization is prohibited. Offenders will be held liable for the payment of damages. All rights reserved in the event of the grant of a patent, utility model or design. Observe copyright by ISO 16016</small>			release date: 11.10.2023	sheet: 1/1

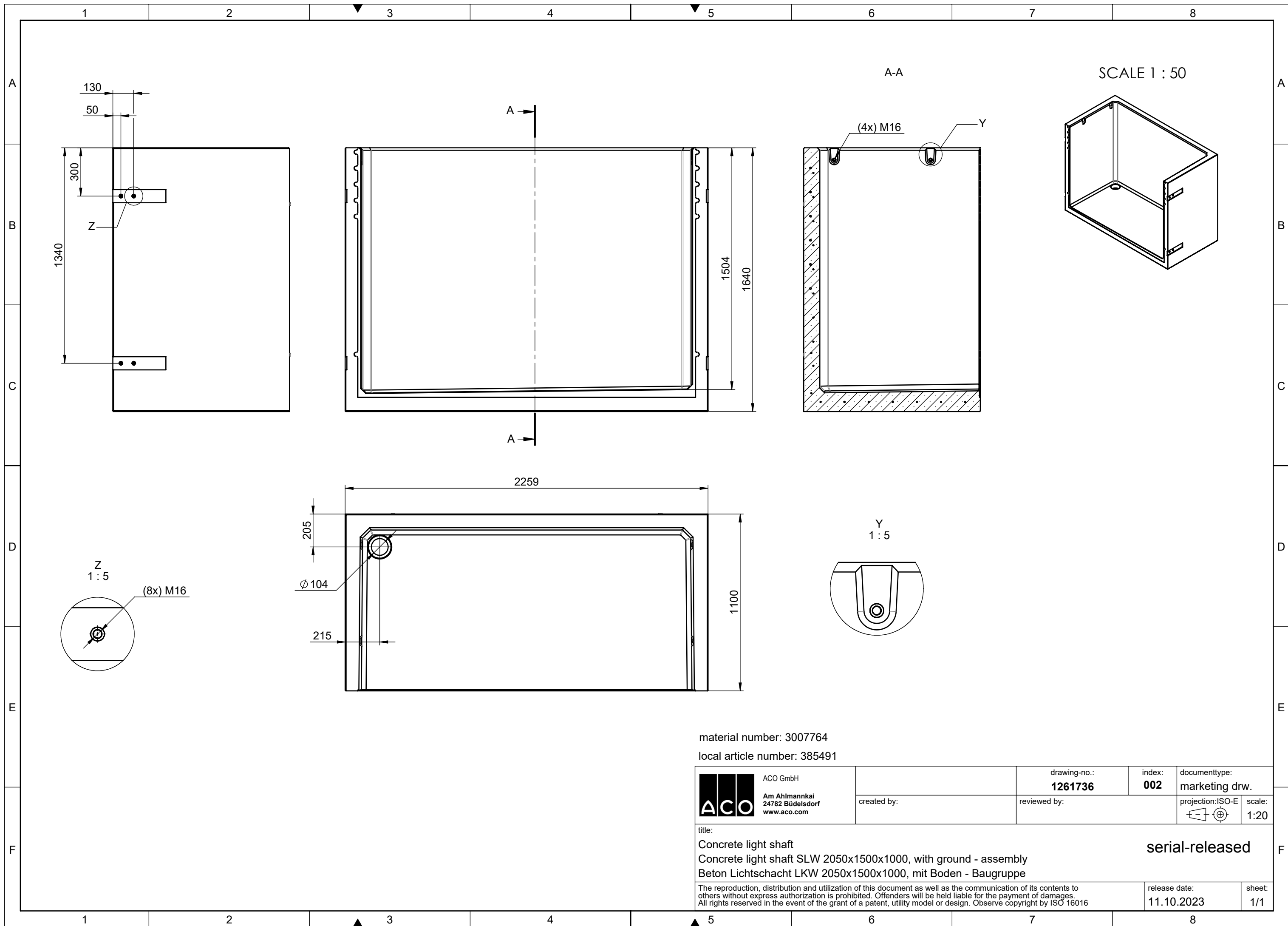

material number: 3007764

local article number: 385491

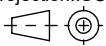
 ACO GmbH Am Ahlmannkai 24782 Büdelsdorf www.aco.com	drawing-no.: 1261736	index: 002	documenttype: marketing drw.	
	created by:	reviewed by:	projection: ISO-E 	scale: 1:20
title: Concrete light shaft Concrete light shaft SLW 2050x1500x1000, with ground - assembly Beton Lichtschacht LKW 2050x1500x1000, mit Boden - Baugruppe			serial-released	
<small>The reproduction, distribution and utilization of this document as well as the communication of its contents to others without express authorization is prohibited. Offenders will be held liable for the payment of damages. All rights reserved in the event of the grant of a patent, utility model or design. Observe copyright by ISO 16016</small>			release date: 11.10.2023	sheet: 1/1

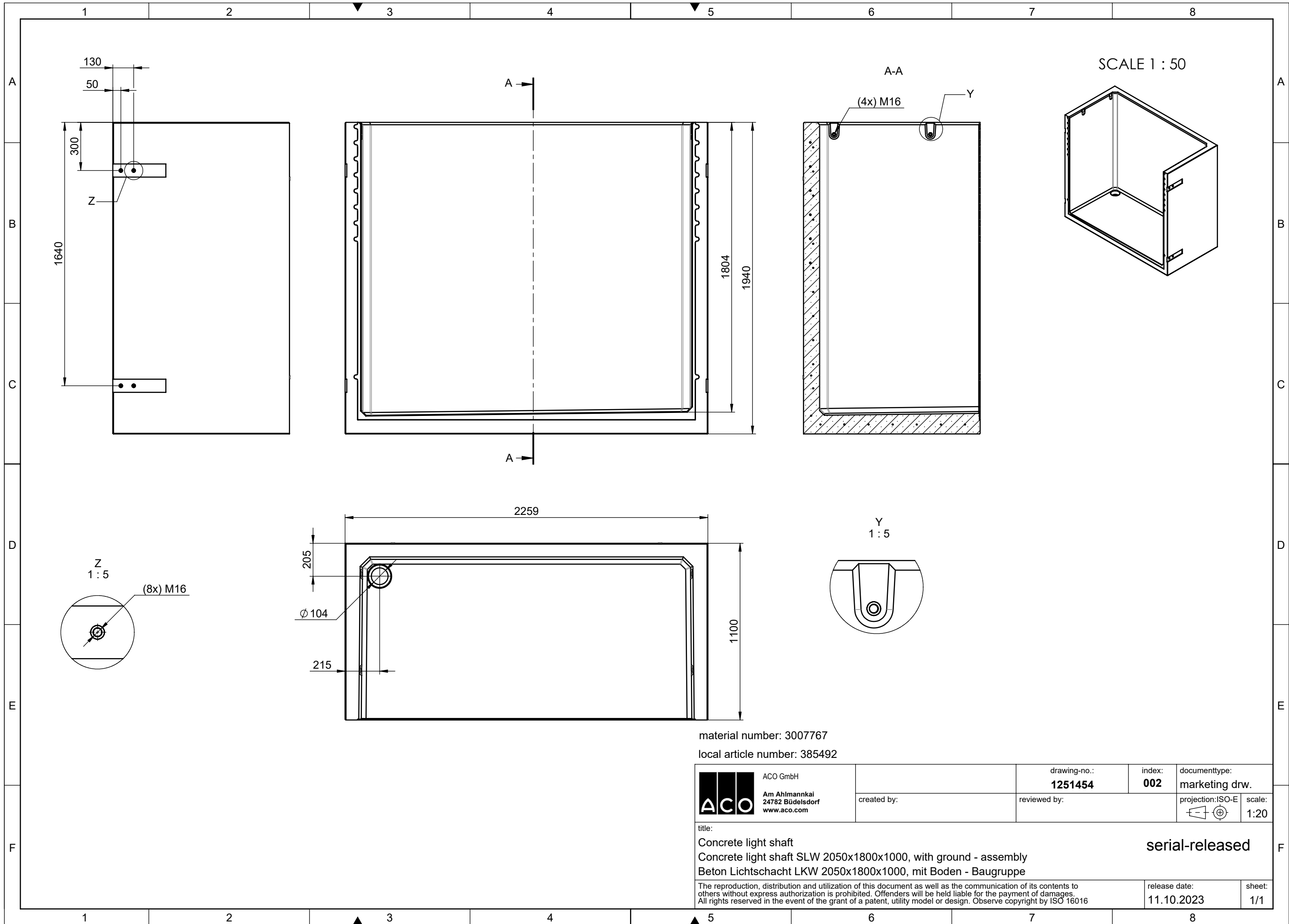

material number: 3007767

local article number: 385492

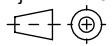
 ACO GmbH Am Ahlmannkai 24782 Büdelsdorf www.aco.com	drawing-no.: 1251454	index: 002	documenttype: marketing drw.	
	created by:	reviewed by:	projection: ISO-E 	scale: 1:20
title: Concrete light shaft Concrete light shaft SLW 2050x1800x1000, with ground - assembly Beton Lichtschacht LKW 2050x1800x1000, mit Boden - Baugruppe			serial-released	
<small>The reproduction, distribution and utilization of this document as well as the communication of its contents to others without express authorization is prohibited. Offenders will be held liable for the payment of damages. All rights reserved in the event of the grant of a patent, utility model or design. Observe copyright by ISO 16016</small>			release date: 11.10.2023	sheet: 1/1

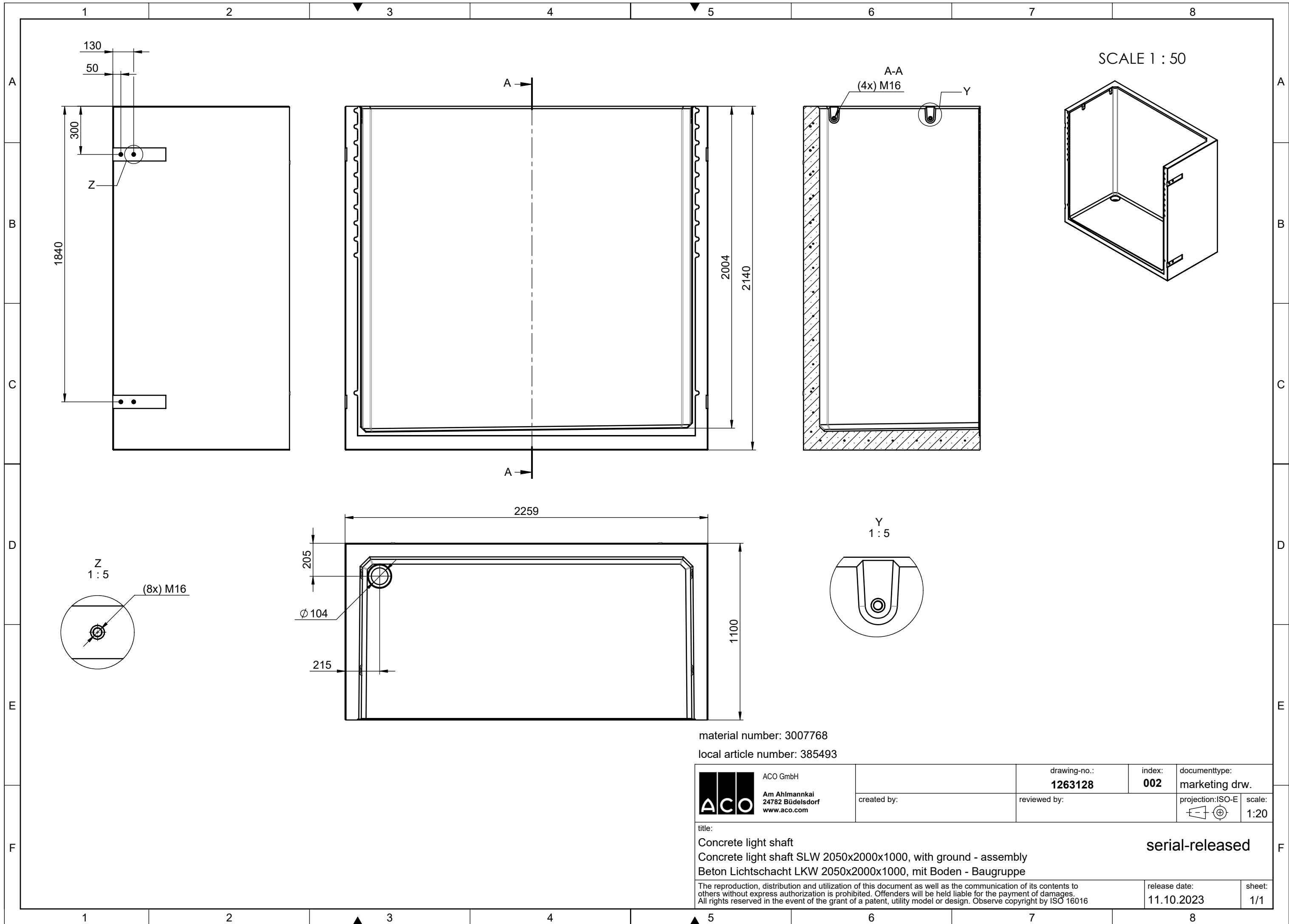

material number: 3007768

local article number: 385493

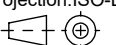
 ACO GmbH Am Ahlmannkai 24782 Büdelsdorf www.aco.com	drawing-no.: 1263128	index: 002	documenttype: marketing drw.	
	created by:	reviewed by:	projection: ISO-E 	scale: 1:20
title: Concrete light shaft Concrete light shaft SLW 2050x2000x1000, with ground - assembly Beton Lichtschacht LKW 2050x2000x1000, mit Boden - Baugruppe			serial-released	
<small>The reproduction, distribution and utilization of this document as well as the communication of its contents to others without express authorization is prohibited. Offenders will be held liable for the payment of damages. All rights reserved in the event of the grant of a patent, utility model or design. Observe copyright by ISO 16016</small>			release date: 11.10.2023	sheet: 1/1