

material number: 2003182
 local article number: 132375

 ACO Ahlmann SE & Co. KG Am Ahlmannkai 24782 Büdelsdorf www.aco.com	drawing-no.: 1037975-M	index: 005	documenttype: marketing drw.
	created by: rkumar	reviewed by: smeier	projection:ISO-E 
title: Multiline Seal in Step Adapter V100S 0,5m 10-20 with galv. steel rail Adapter für Stufengefälle V100S 0,5m 10-20 mit verzinkter Stahlzarge			serial-released
<small>The reproduction, distribution and utilization of this document as well as the communication of its contents to others without express authorization is prohibited. Offenders will be held liable for the payment of damages. All rights reserved in the event of the grant of a patent, utility model or design. Observe copyright by ISO 16016</small>			release date: 07.02.2023
			sheet: 1/1

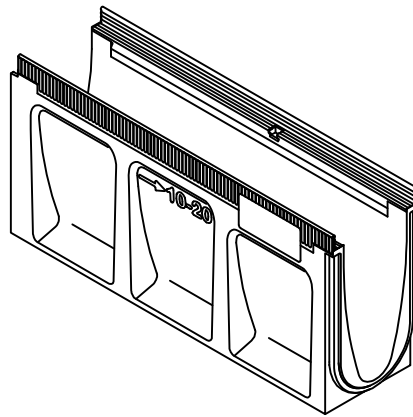
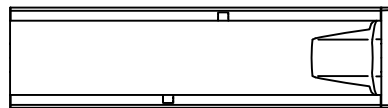
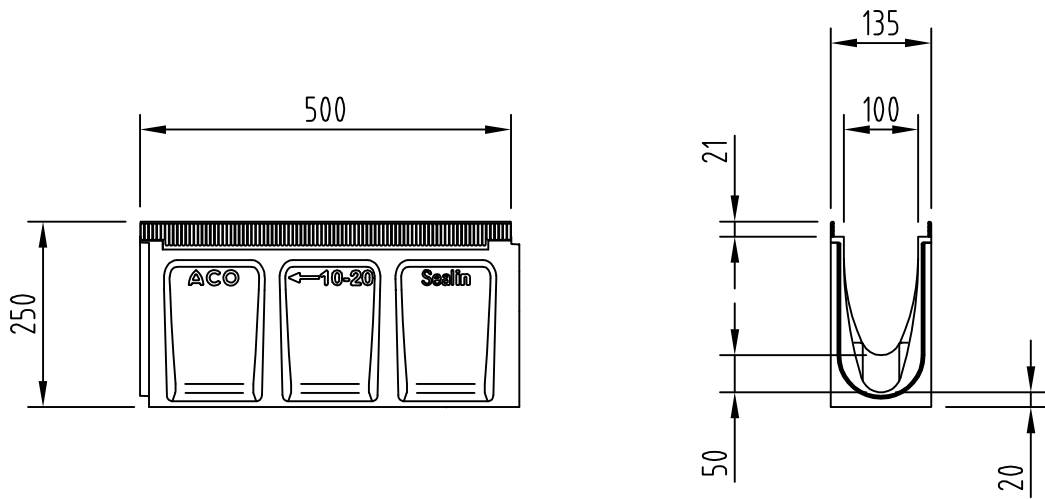

Benennung:
 ACO DRAIN Multiline V 100 Seal in
 Rinnenkörper mit Sohlensprung 5 cm, L= 0,5 m
 Art.-Nr. 132375 (Stahl verzinkt), 132475 (V2A)

	Datum	Name
Gez.	19.04.2016	debeling
Upd.	18.01.2017	debeling
Norm		



ACO Tiefbau

ACO Tiefbau Vertrieb GmbH
 24755 Rendsburg, Postfach 320
 Tel. 04331 / 354-500
 FAX 04331 / 354-350
 www.aco-tiefbau.de

Zeichnung-Nr.
 G1-M01-1534-3

Index
 001

Technische Änderungen vorbehalten

Schutzvermerk gemäß DIN 34

Ers. für:

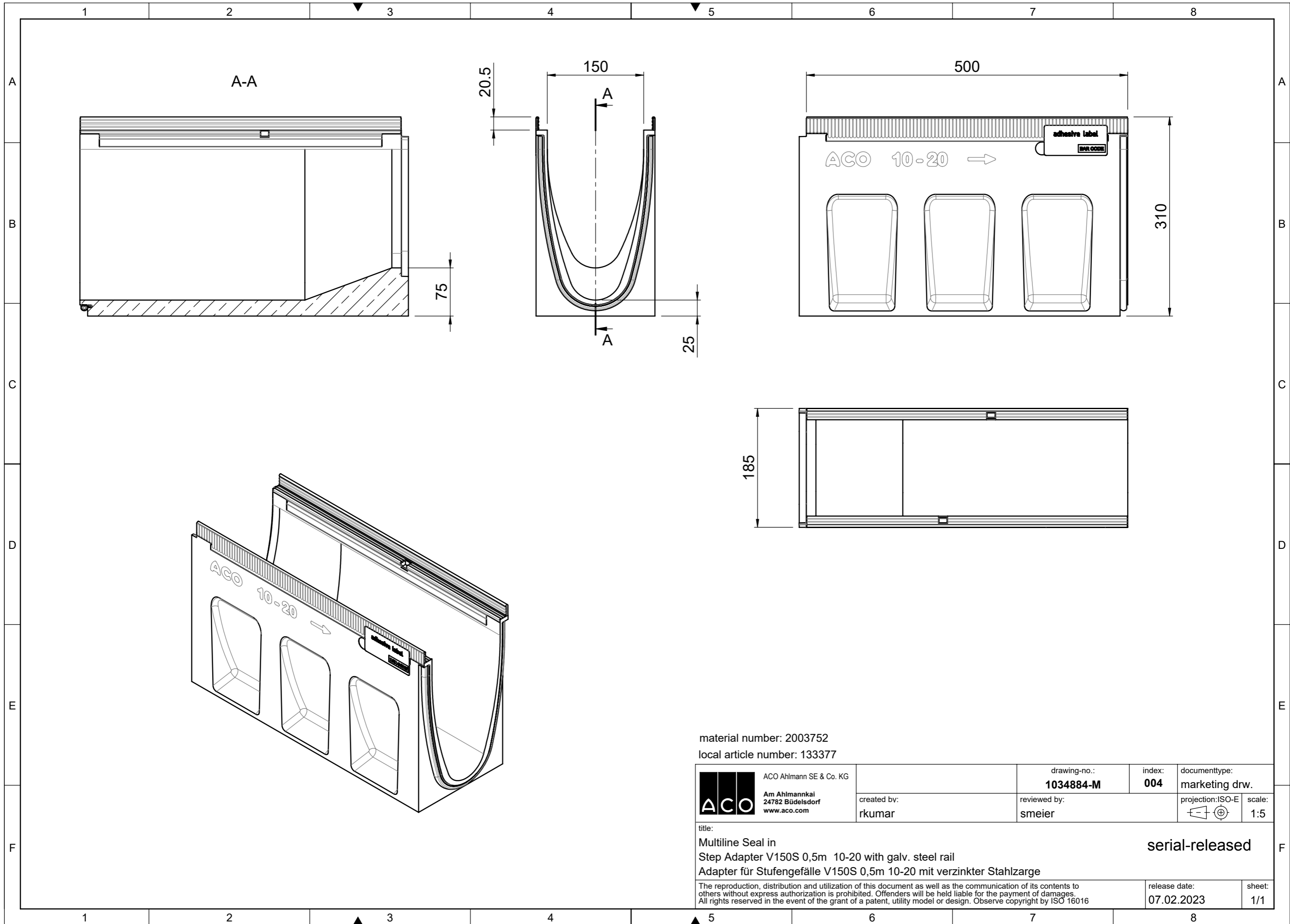

material number: 2003752
 local article number: 133377

 ACO Ahlmann SE & Co. KG Am Ahlmannkai 24782 Büdelsdorf www.aco.com	drawing-no.: 1034884-M	index: 004	documenttype: marketing drw.
	created by: rkumar	reviewed by: smeier	projection: ISO-E 

title:
 Multiline Seal in
 Step Adapter V150S 0,5m 10-20 with galv. steel rail
 Adapter für Stufengefälle V150S 0,5m 10-20 mit verzinkter Stahlzarge

serial-released

The reproduction, distribution and utilization of this document as well as the communication of its contents to others without express authorization is prohibited. Offenders will be held liable for the payment of damages. All rights reserved in the event of the grant of a patent, utility model or design. Observe copyright by ISO 16016	release date: 07.02.2023	sheet: 1/1
--	------------------------------------	---------------

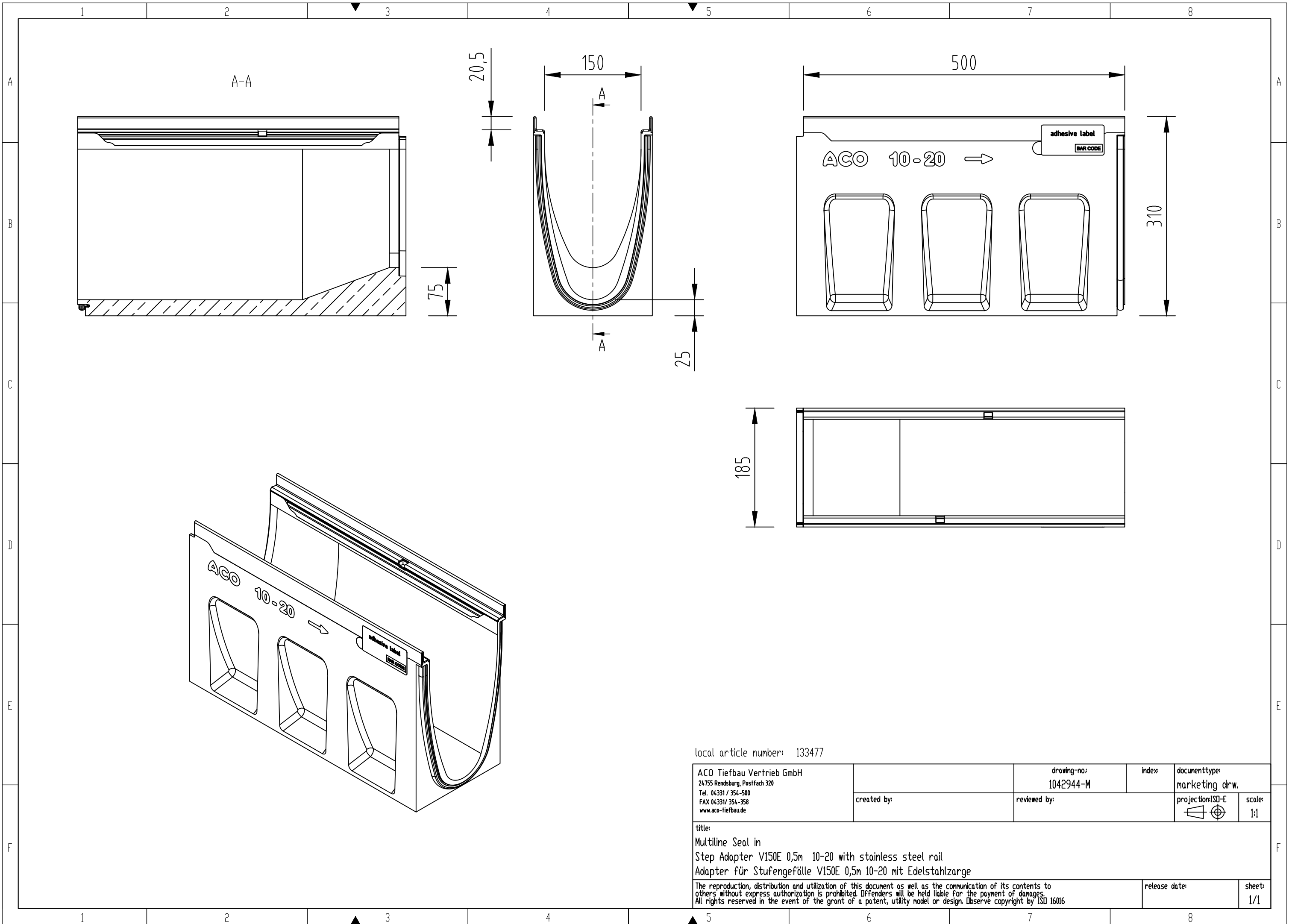

local article number: 133477

ACO Tiefbau Vertrieb GmbH 24755 Rendsburg, Postfach 320 Tel. 04331 / 354-500 FAX 04331/ 354-358 www.aco-tiefbau.de	drawing-no: 1042944-M	index:	documenttype: marketing drw.
	created by:	reviewed by:	projection:ISO-E 
title: Multiline Seal in Step Adapter V150E 0,5m 10-20 with stainless steel rail Adapter für Stufengefälle V150E 0,5m 10-20 mit Edelstahlzarge			scale: 1:1
The reproduction, distribution and utilization of this document as well as the communication of its contents to others without express authorization is prohibited. Offenders will be held liable for the payment of damages. All rights reserved in the event of the grant of a patent, utility model or design. Observe copyright by ISO 16016			release date: sheet: 1/1

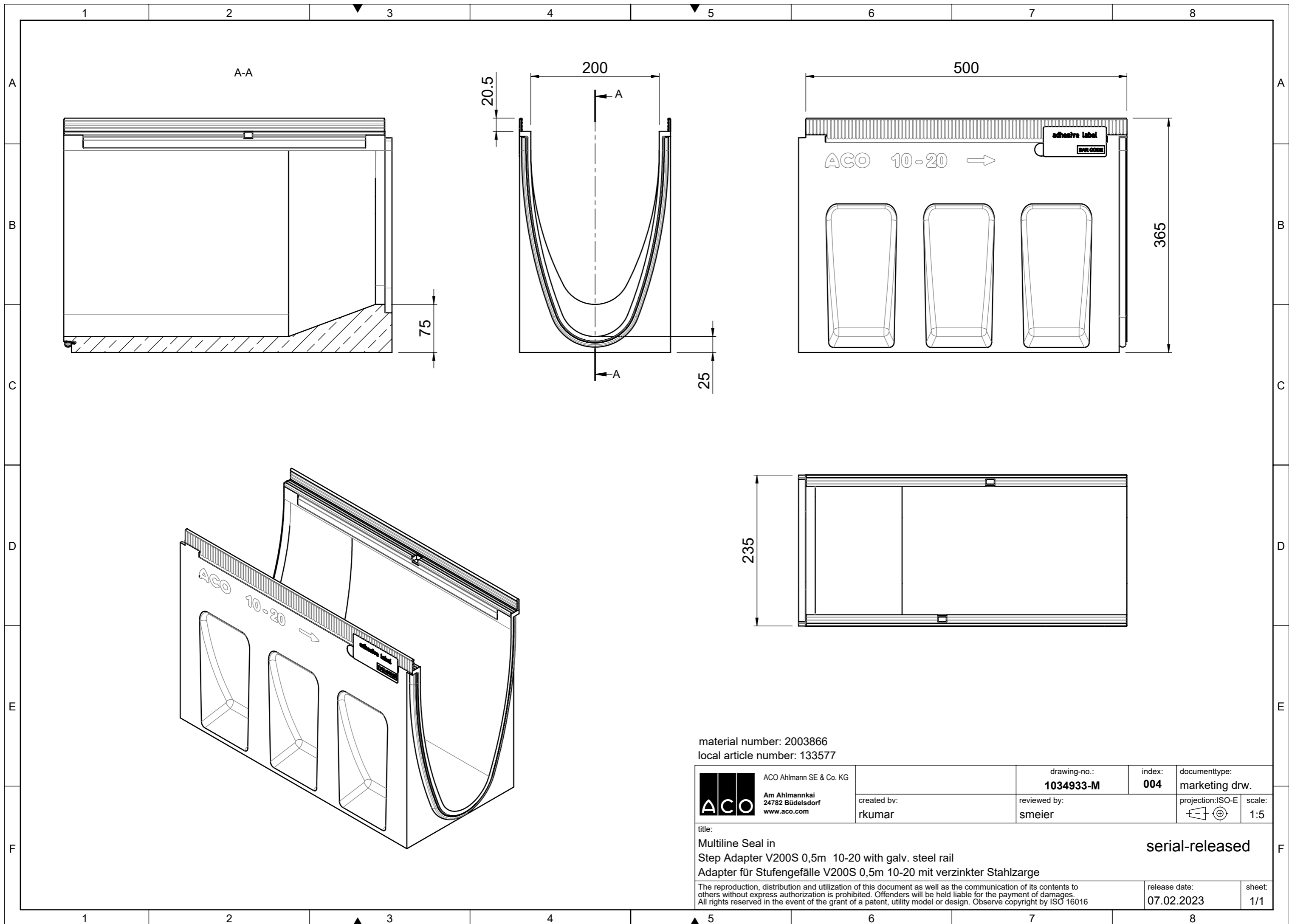

material number: 2003866
 local article number: 133577

 ACO Ahlmann SE & Co. KG Am Ahlmannkai 24782 Büdelsdorf www.aco.com	drawing-no.: 1034933-M	index: 004	documenttype: marketing drw.
	created by: rkumar	reviewed by: smeier	projection: ISO-E 
title: Multiline Seal in Step Adapter V200S 0,5m 10-20 with galv. steel rail Adapter für Stufengefälle V200S 0,5m 10-20 mit verzinkter Stahlzarge			serial-released
<small>The reproduction, distribution and utilization of this document as well as the communication of its contents to others without express authorization is prohibited. Offenders will be held liable for the payment of damages. All rights reserved in the event of the grant of a patent, utility model or design. Observe copyright by ISO 16016</small>			release date: 07.02.2023
			sheet: 1/1

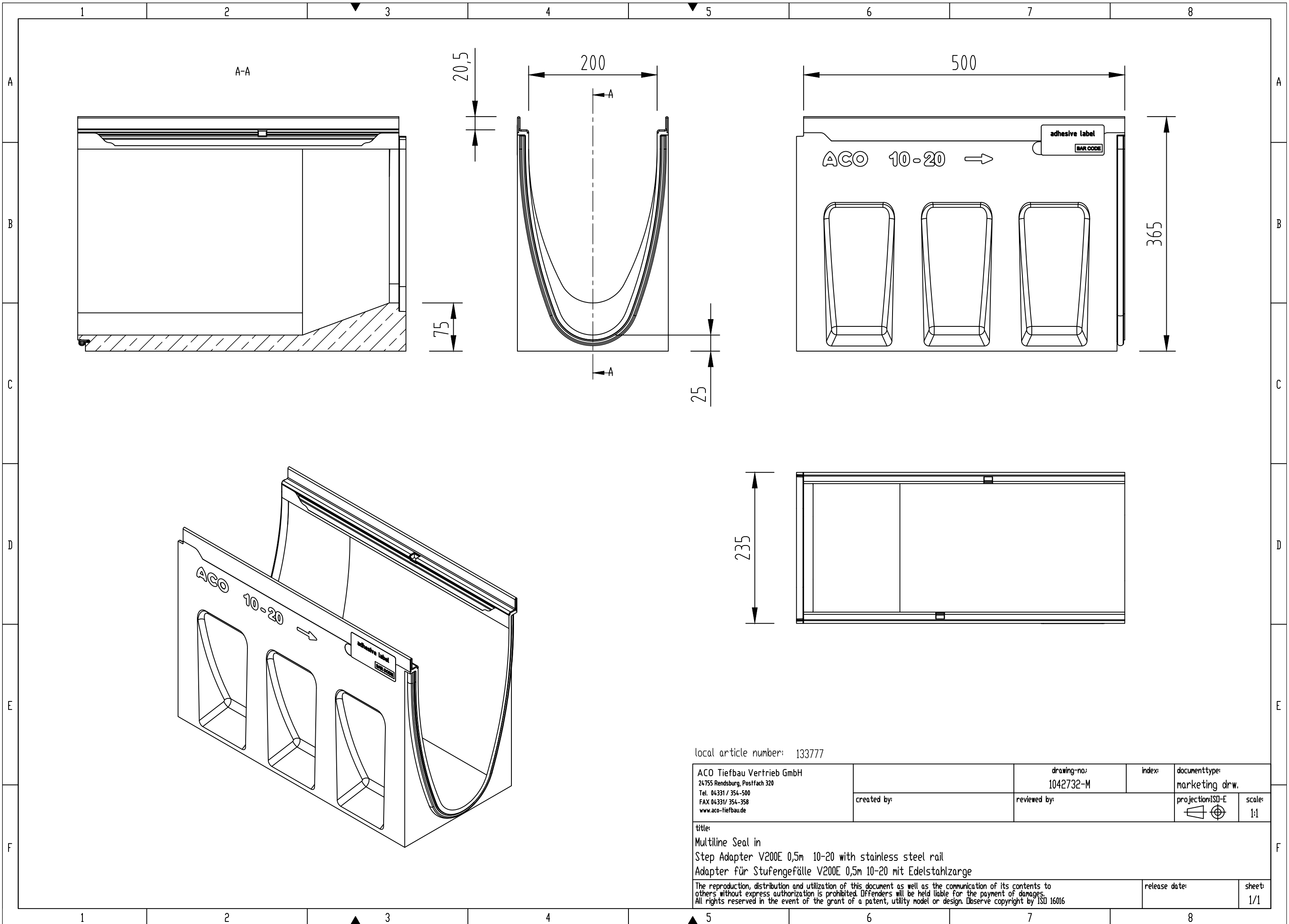

local article number: 133777

ACO Tiefbau Vertrieb GmbH 24755 Rendsburg, Postfach 320 Tel. 04331 / 354-500 FAX 04331/ 354-358 www.aco-tiefbau.de	drawing-no: 1042732-M	index:	documenttype: marketing drw.
	created by:	reviewed by:	projection:ISO-E scale: 1:1
title: Multiline Seal in Step Adapter V200E 0,5m 10-20 with stainless steel rail Adapter für Stufengefälle V200E 0,5m 10-20 mit Edelstahlzarge			release date:
The reproduction, distribution and utilization of this document as well as the communication of its contents to others without express authorization is prohibited. Offenders will be held liable for the payment of damages. All rights reserved in the event of the grant of a patent, utility model or design. Observe copyright by ISO 16016			sheet: 1/1

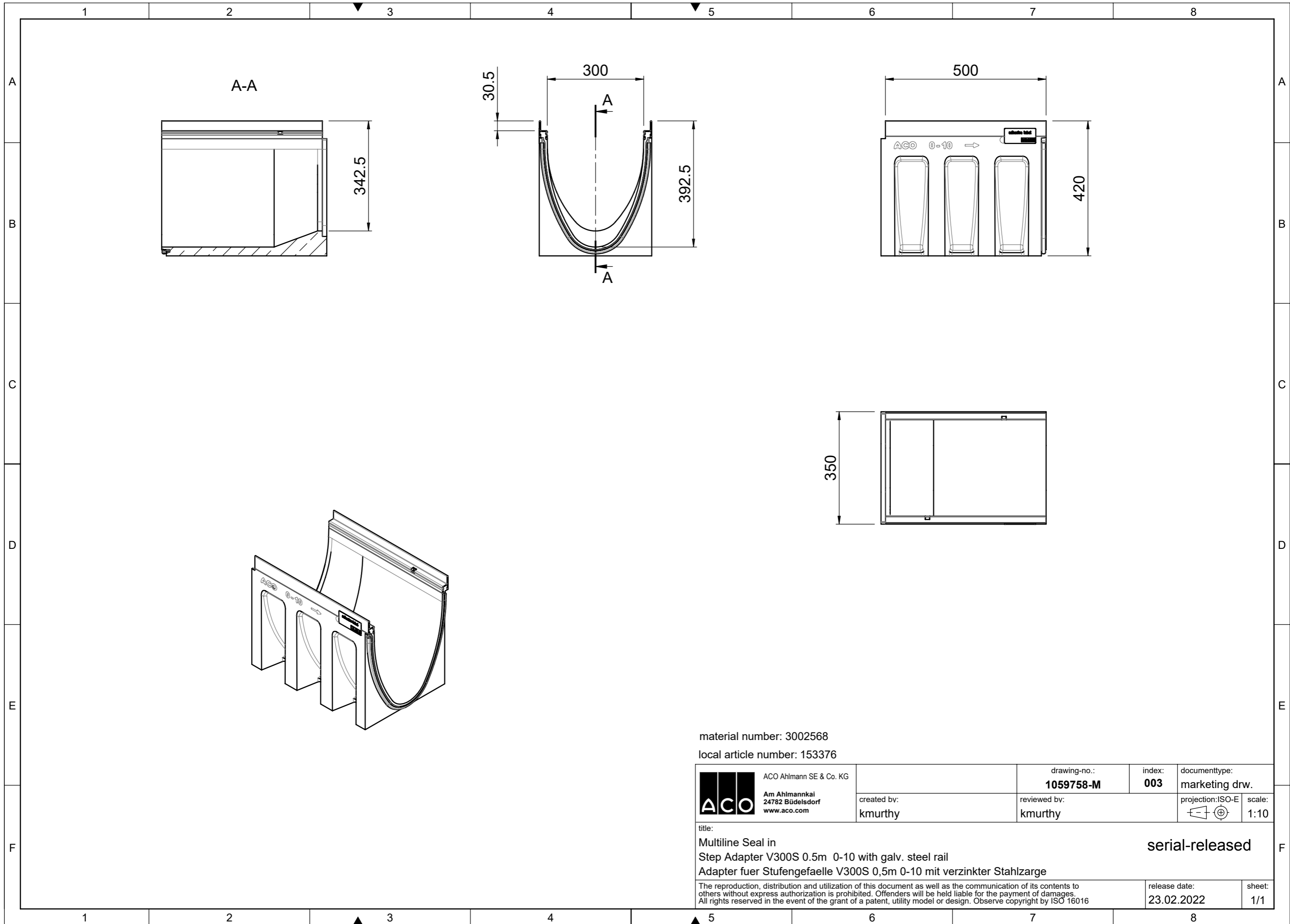

material number: 3002568

local article number: 153376

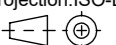
 ACO Ahlmann SE & Co. KG Am Ahlmannkai 24782 Büdelsdorf www.aco.com	drawing-no.: 1059758-M	index: 003	documenttype: marketing drw.
	created by: kmurthy	reviewed by: kmurthy	projection: ISO-E 
title: Multiline Seal in Step Adapter V300S 0.5m 0-10 with galv. steel rail Adapter fuer Stufengefaelle V300S 0,5m 0-10 mit verzinkter Stahlzarge			serial-released
<small>The reproduction, distribution and utilization of this document as well as the communication of its contents to others without express authorization is prohibited. Offenders will be held liable for the payment of damages. All rights reserved in the event of the grant of a patent, utility model or design. Observe copyright by ISO 16016</small>			release date: 23.02.2022
			sheet: 1/1

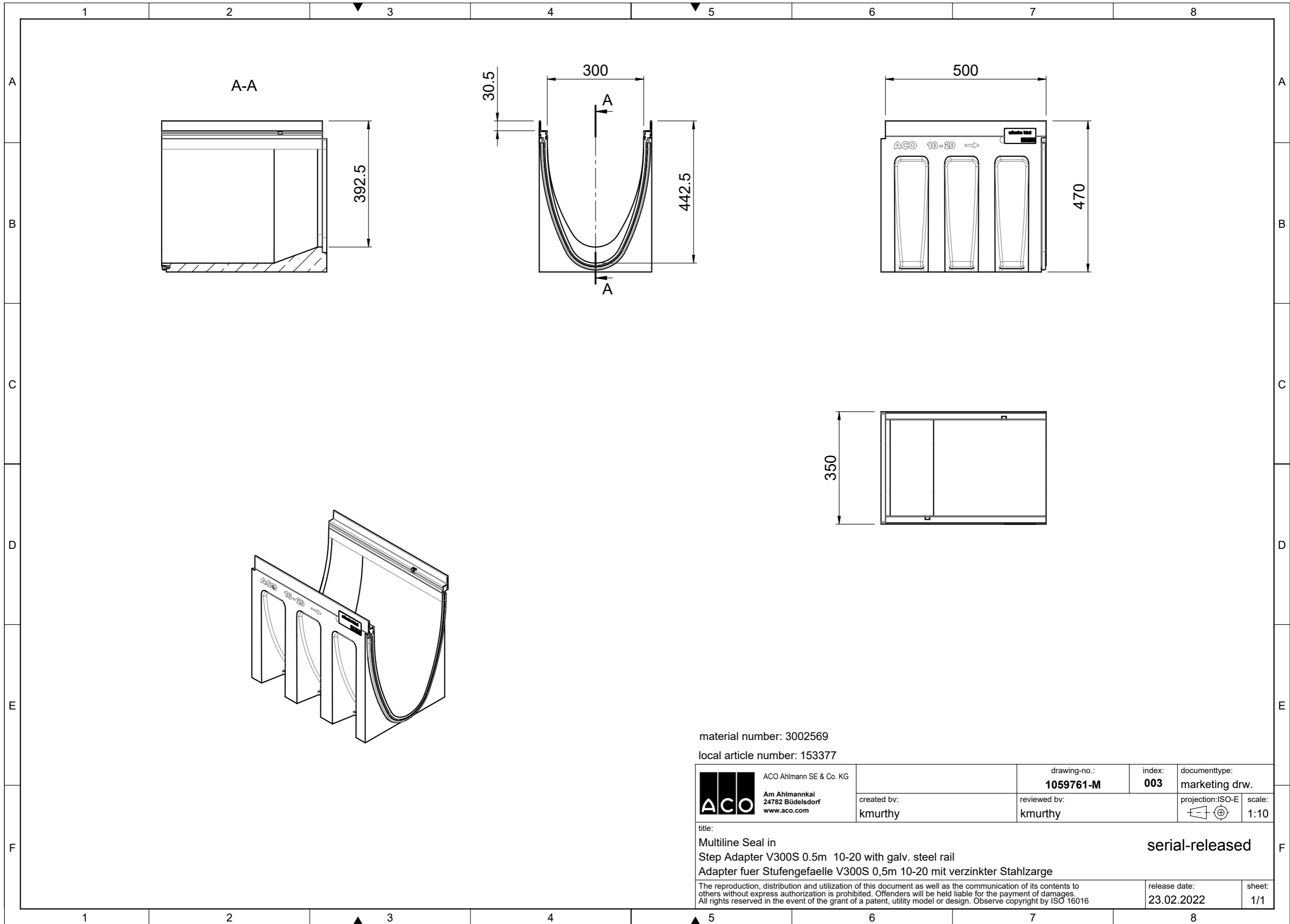

material number: 3002569

local article number: 153377

 ACO Ahlmann SE & Co. KG Am Ahlmannkai 24782 Büdelsdorf www.aco.com	drawing-no.: 1059761-M	index: 003	documenttype: marketing drw.
	created by: kmurthy	reviewed by: kmurthy	projection: ISO-E 
title: Multiline Seal in Step Adapter V300S 0.5m 10-20 with galv. steel rail Adapter fuer Stufengefaelle V300S 0,5m 10-20 mit verzinkter Stahlzarge			serial-released
<small>The reproduction, distribution and utilization of this document as well as the communication of its contents to others without express authorization is prohibited. Offenders will be held liable for the payment of damages. All rights reserved in the event of the grant of a patent, utility model or design. Observe copyright by ISO 16016</small>			release date: 23.02.2022
			sheet: 1/1

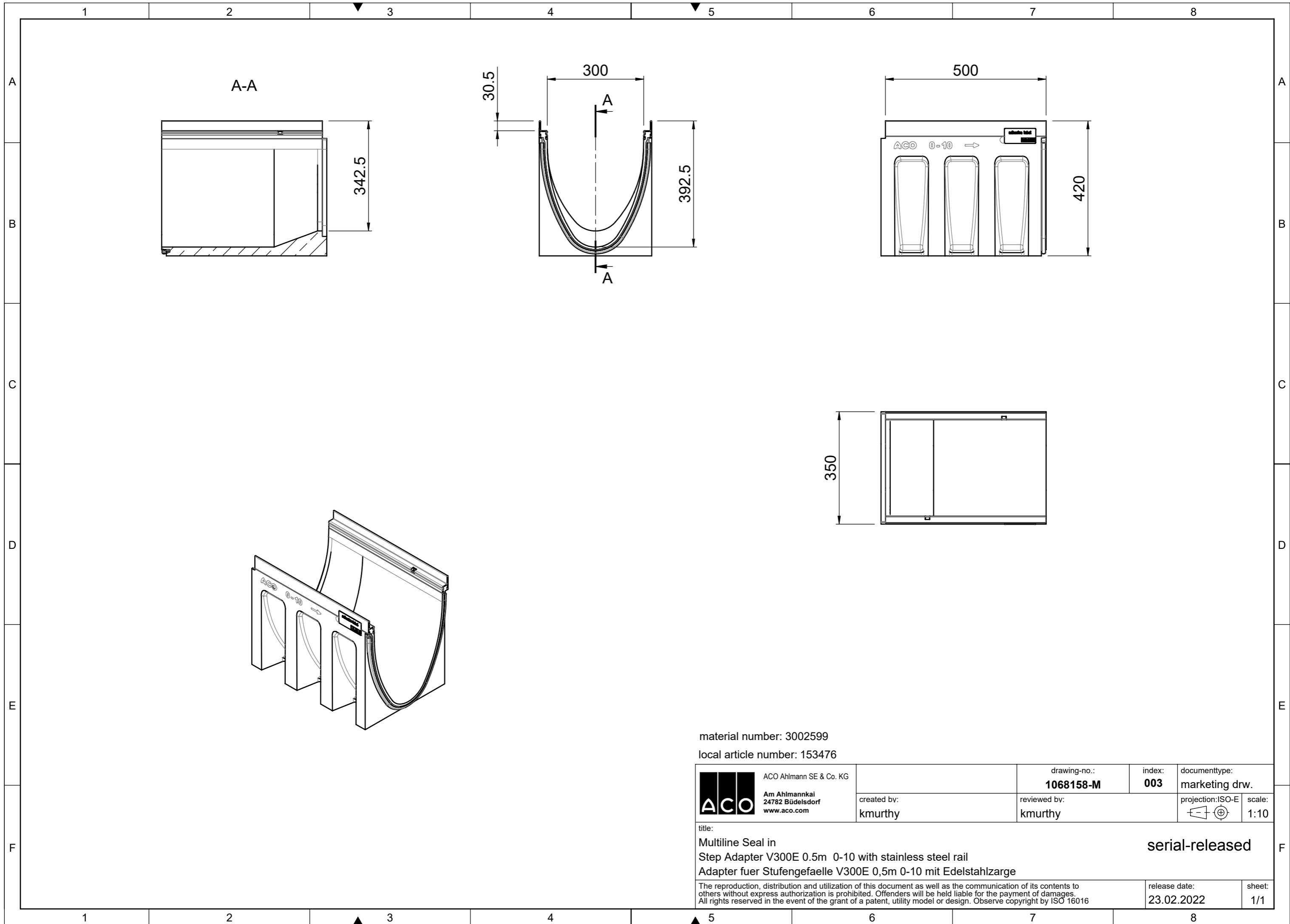

material number: 3002599

local article number: 153476

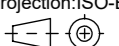
 ACO Ahlmann SE & Co. KG Am Ahlmannkai 24782 Büdelsdorf www.aco.com	drawing-no.: 1068158-M	index: 003	documenttype: marketing drw.
	created by: kmurthy	reviewed by: kmurthy	projection: ISO-E 
title: Multiline Seal in Step Adapter V300E 0.5m 0-10 with stainless steel rail Adapter fuer Stufengefaelle V300E 0,5m 0-10 mit Edelstahlzarge			serial-released
<small>The reproduction, distribution and utilization of this document as well as the communication of its contents to others without express authorization is prohibited. Offenders will be held liable for the payment of damages. All rights reserved in the event of the grant of a patent, utility model or design. Observe copyright by ISO 16016</small>			release date: 23.02.2022
			sheet: 1/1

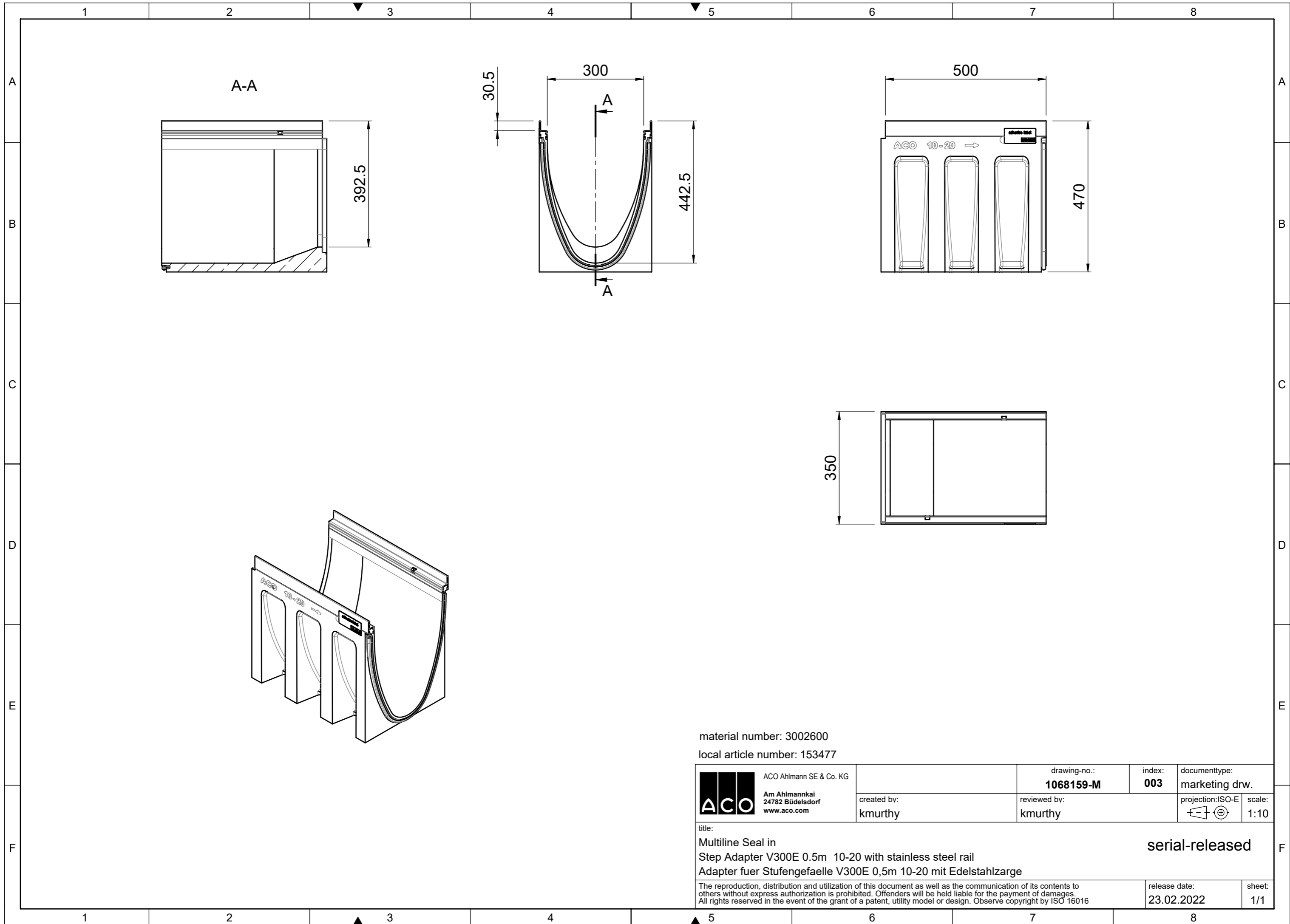

material number: 3002600

local article number: 153477

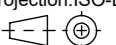
 ACO Ahlmann SE & Co. KG Am Ahlmannkai 24782 Büdelsdorf www.aco.com	drawing-no.: 1068159-M	index: 003	documenttype: marketing drw.	
	created by: kmurthy	reviewed by: kmurthy	projection: ISO-E 	scale: 1:10
title: Multiline Seal in Step Adapter V300E 0.5m 10-20 with stainless steel rail Adapter fuer Stufengefaelle V300E 0,5m 10-20 mit Edelstahlzarge			serial-released	
<small>The reproduction, distribution and utilization of this document as well as the communication of its contents to others without express authorization is prohibited. Offenders will be held liable for the payment of damages. All rights reserved in the event of the grant of a patent, utility model or design. Observe copyright by ISO 16016</small>			release date: 23.02.2022	sheet: 1/1